

467

FL53f xiii

**STRATEGIC SYSTEMS  
TEST SUPPORT STUDY  
(SSTSS)**

IIe  
10-12

**Final Report  
Volume II  
Supporting Analyses (U)**

November 1981

Prepared by SRI International,  
Menlo Park, California 94025

for

The SSTSS Ad Hoc Executive Committee  
Dr. James A. Means, SAMTO/CA, Chairman  
Dr. Charles D. Smith, BMDSCOM-RD, Co-Chairman  
Mr. Vincent J. Prestipino, NAVAIRSYSCOM, Co-Chairman

Contract N00024-78-C-5384

Classified by: DD Form 254, 14 May 1980,  
Contract N00024-78-C-5384  
Review on: October 1996

Reviewed per AR 330-5  
on 10 Dec 82 by [Signature]

SRI DOCUMENT # 1-8444  
COPY # 6 PROJECT 1715

REPORT DOCUMENTATION PAGE		READ INSTRUCTIONS BEFORE COMPLETING FORM	
1. REPORT NUMBER	2. GOVT ACCESSION NO.	3. RECIPIENT'S CATALOG NUMBER	
4. TITLE (and Subtitle) STRATEGIC SYSTEMS TEST SUPPORT STUDY (SSTSS) Vol I Executive Summary Vol II Supporting Analyses Vol III Appendices--Tri-Service Requirements		5. TYPE OF REPORT & PERIOD COVERED Final Task Report October 1979 - November 1981	
7. AUTHOR(s) E. G. Blackwell      E. A. Erb      J. R. Seiders G. E. Barker      H. H. Album      M. Wright J. W. Willett		6. PERFORMING ORG. REPORT NUMBER	
9. PERFORMING ORGANIZATION NAME AND ADDRESS SSTSS Ad Hoc Committee; prepared by: SRI International, 333 Ravenswood Ave. Menlo Park, CA 94025		8. CONTRACT OR GRANT NUMBER(s) DASG60-80-C-0069	
11. CONTROLLING OFFICE NAME AND ADDRESS Ballistic Missile Defense Systems Command P.O. Box 1500 Huntsville, AL 35807		10. PROGRAM ELEMENT, PROJECT, TASK AREA & WORK UNIT NUMBERS	12. REPORT DATE November 1981
14. MONITORING AGENCY NAME & ADDRESS (if diff. from Controlling Office)  OUSDRE/DDTE The Pentagon, Washington, D.C.		13. NO. OF PAGES 276	15. SECURITY CLASS. (of this report)  SECRET
16. DISTRIBUTION STATEMENT (of this report)  Distribution limited to U.S. Government agencies only: test and evaluation, November 1981. Other requests for this document must be referred to OUSDRE/DDTE.		15a. DECLASSIFICATION/DOWNGRADING SCHEDULE Review in October 1996	
17. DISTRIBUTION STATEMENT (of the abstract entered in Block 20, if different from report)			
18. SUPPLEMENTARY NOTES			
19. KEY WORDS (Continue on reverse side if necessary and identify by block number) MX Test Support Requirements TRIDENT Test Support Requirements BMD Test Support Requirements Kwajalein Missile Range Alternatives Range Instrumentation Ships Advanced Range Instrumentation Aircraft			
20. ABSTRACT (Continue on reverse side if necessary and identify by block number) (U) The Strategic Systems Test Support Study (SSTSS) (November 1979-September 1981) was performed by a tri-service ad hoc committee to deal with questions facing DoD concerning the future of terminal area test support resources. The study analyzed future requirements of strategic weapon testing and examined existing terminal area support resources. These resources included Kwajalein Missile Range (KMR) and mobile instrumentation aircraft and ships. Deficiencies and short-falls were identified, and various alternatives were studied to arrive at (1) a contingency island location if political stresses force evacuation of KMR, (2) an			

UNCLASSIFIED ~~CONFIDENTIAL~~

(U) MX flight tests (DT&E and IOT&E) will require multiple-object telemetry and scoring in the ITA as well as simple streak photography and meteorological data. Metric data are not required, but will be acquired if the capability is readily available in the ITA. Radar signature data will be required in the ITA only if new penetration aids (PENAIIDs) are developed; however, this is not planned. Similarly, land impact will be required only if new fusing is developed. In the BOA, only telemetry, scoring, and simple streak photography of multiple reentry vehicles (RVs) are required. Meteorological data may be desired in the BOA for accuracy assessment tests.

UNCLASSIFIED

~~CONFIDENTIAL~~

SECURITY CLASSIFICATION OF THIS PAGE (When Data Entered)

19. KEY WORDS (Continued)

Ballistic Missile Terminal Area Support  
Universal Range Instrumentation Aircraft

20 ABSTRACT (Continued)

economically and operationally improved support aircraft resource posture, (3) a plan for reduced terminal area support ships, and (4) supplemental land-based instrumentation concepts to reduce the cost of broad ocean area test support provided by CONUS-based instrumentation aircraft. An implementation plan and budgetary requirements were also developed.

# UNCLASSIFIED

## ABSTRACT (U)

(U) The Strategic Systems Test Support Study (SSTSS), November 1979 to September 1981, was performed by a tri-service ad hoc committee to deal with problems facing the DoD concerning the future of terminal area test support resources. The study analyzed future support requirements and examined existing Atlantic and Pacific terminal area resources: Kwajalein Missile Range (KMR), Ascension Island, and mobile instrumentation aircraft and ships. Deficiencies were identified, and various alternatives were studied to provide: (1) a contingency island location to KMR if political stress forced its evacuation, (2) an economically and operationally improved support aircraft resource posture, (3) a reduced terminal area support ship plan, and (4) supplemental land-based instrumentation concepts to reduce the cost of broad ocean area test support by CONUS-based instrumentation aircraft. A development plan and budgetary requirements are provided.

CONTENTS (Continued) (U)

IV	EXISTING ITA RESOURCES AND ALTERNATIVES (U) . . . . .	45
A.	Existing ITA Resources (U) . . . . .	45
	1. Ascension Island (U) . . . . .	45
	2. Kwajalein Missile Range (U) . . . . .	47
B.	SSTSS Alternatives to KMR (U) . . . . .	55
	1. ITA Selection Criteria (U) . . . . .	56
	2. Initial Alternatives (U) . . . . .	58
	C. Preferred Alternative to KMR: A Split Range (U) . . . . .	70
	1. . . . .	72
	2. Transition Planning (U) . . . . .	73
	3. Cost of Relocation (U) . . . . .	76
V	EXISTING MOBILE INSTRUMENTATION RESOURCES AND ALTERNATIVES (U) . . . . .	79
A.	General (U) . . . . .	79
B.	Baseline Advanced Range Instrumentation Aircraft (ARIA) (U) . . . . .	80
	1. ARIA Capabilities (U) . . . . .	81
	2. ARIA Deficiencies and Improvements (U) . . . . .	85
	3. ARIA Baseline Workload (U) . . . . .	88
	4. Baseline Costs of ARIA (U) . . . . .	94
C.	P-3C SMILS Aircraft (U) . . . . .	94
	1. P-3C SMILS Aircraft Capabilities (U) . . . . .	96
	2. Workload Analysis for P-3C SMILS (U) . . . . .	98
	3. Existing P-3C SMILS Deficiencies and Improvements (U) . . . . .	98
	4. Baseline Costs for P-3C SMILS (U) . . . . .	103
D.	Alternative Mobile Instrumentation Aircraft Considerations (U) . . . . .	103
	1. Discussion (U) . . . . .	103
	2. ARIA Requirements Analysis Results (U) . . . . .	107
	3. ARIA Study Options (U) . . . . .	112
	4. Option Cost Trade-off and Ranking (U) . . . . .	123
	5. Conclusions and Recommendations (U) . . . . .	139
E.	Advanced Range Instrumentation Ships (U) . . . . .	149
	1. ARIS Capabilities (U) . . . . .	149
	2. ARIS Deficiencies and Improvements (U) . . . . .	157
	3. Future Ship Workload Projections (U) . . . . .	158
	4. Baseline ARIS Costs (U) . . . . .	166

? (C) → X

*MM*

# UNCLASSIFIED

## CONTENTS (Concluded) (U)

F.	SSTSS Recommendations for Ship Alternatives (U) . . .	166
1.	Review of Ship Support Needs (U) . . . . .	169
2.	Recommendations for Ship Resources (U) . . . . .	170
3.	Costs of Alternatives to Baseline ARIS (U) . . .	174
VI	SUPPLEMENTAL LAND-BASED ALTERNATIVES (U) . . . . .	179
A.	Supplemental Land-Based Instrumentation Concepts (U) . . . . .	179
1.	SLTA Locations and Targeting Constraints (U) . .	179
2.	Overview of SLTA Instrumentation Alternatives (U) . . . . .	182
B.	Recommended Mobile Instrumentation Support at KMRN (U) . . . . .	189
1.	C-7A TASA (U) . . . . .	192
2.	Kwajalein Broad Ocean Area Tug (K-BOAT) (U) . .	199
3.	Transportable Telemetry System (TTS) (U) . . . .	203
4.	KMRN Resource Development Schedule (U) . . . . .	204
C.	Recommended SLTA Instrumentation Concept (U) . . . . .	204
1.	Design Evolution (U) . . . . .	204
2.	SLTA Configuration (U) . . . . .	207
3.	Site Survey (U) . . . . .	210
4.	SLTA Cost Analysis (U) . . . . .	211
VII	MISCELLANEOUS TOPICS (U) . . . . .	215
A.	EATS/APATS Telemetry Performance Comparisons (U) . . .	215
1.	Analysis Overview (U) . . . . .	215
2.	General Description: EATS and APATS Antennas (U) . . . . .	215
3.	Analysis Factors and Results (U) . . . . .	217
B.	Impact of the Repopulation of Bigej Island (U) . . . . .	221
1.	Introduction (U) . . . . .	221
2.	Air Force Programs Analysis (U) . . . . .	223
3.	Army Programs Analysis (U) . . . . .	228
4.	Conclusions (U) . . . . .	234
5.	Recommendation (U) . . . . .	235
	BIBLIOGRAPHY . . . . .	237
	REFERENCES . . . . .	249

ILLUSTRATIONS (U)

1	Average Target Range and West Firing Equivalent for MX (U) . . . . .	12
2	Pacific Testing of MX at Representative Test Conditions (U) . . . . .	12
3	Baseline Atlantic Terminal Areas (U) . . . . .	23
4	Baseline TRIDENT Terminal Areas in the Pacific (U) . . . . .	26
5	Summary of Test Program Events Requiring SSTS (U). . . . .	29
6	TRIDENT and MX Weapon System v-γ Test Requirements (U) . . . . .	41
7	Navy and Air Force Pacific BOAs Considered (U) . . . . .	42
8	Pacific Consolidated BOAs (U). . . . .	43
9	Ascension Island Baseline (Atlantic) ITA (U) . . . . .	46
10	Kwajalein Missile Range Baseline (Pacific) ITA (U) . . . . .	48
11		65
12		69
13		71
14		74
15		75
16		78
17	Baseline Mobile Resources Used for Terminal Area Support (U). . . . .	80
18	ARIA Interior Modifications (U). . . . .	81
19	Time-On-Station Comparison of Existing and Upgraded ARIAs (U). . . . .	86



ILLUSTRATIONS (Continued) (U)

20	Time-On-Station for Representative Support Areas (U) . . .	121
21	Cost Effectiveness of Aircraft Alternatives versus Time-On-Station at Oeno (U) . . . . .	122
22	Aircraft Resource Development Plan (U) . . . . .	143
23	ARIS Inboard Profile (U) . . . . .	151
24	USNS General Hoyt S. Vandenberg (U) . . . . .	152
25	Baseline Ship Life-Cycle Costs (U) . . . . .	169
26	Redistribution of Ship Workloads (U) . . . . .	173
27	Alternate Ship Plan Life-Cycle Costs (Cumulative) (U) . .	177
28	Pacific Supplemental Terminal Area Options (U) . . . . .	180
2		181
30	MX Targeting Stand-off Considerations at KMRN (U) . . .	182
31	1 ) . . . . .	186
32	BOAST Concept Using HATS and DME-SMILS (U) . . . . .	187
33	C-7A/SADOTS and SAILS Concepts (U) . . . . .	189
34	. . . . .	190
35	C-7A TASA (SMILS): Recommended KMRN Support Concept (U) . . . . .	193
36	C-7A TASA Design Configuration (U) . . . . .	194
37	C-7A TASA versus P-3 SMILS Cost Comparison for KMRN Support (U) . . . . .	197
38	K-Boat Installation of DOTs at KMRN (U) . . . . .	200
39	Comparative Costs (Cumulative) of K-Boat versus NAVOCEANO Commercial Vessel at KMRN (U) . . . . .	203

ILLUSTRATIONS (Concluded) (U)

40	KMR Transportable Telemetry System (TTS) Design (U) . . . . .	204
41	Integrated Development Schedule for KMRN (U) . . . . .	205
42		208
43		209
44	Cost Comparisons for BOA-1 and -2 versus SLTA and BOA (U) . . . . .	214
45	Elevation Scan G/T Profiles for EATS and APATS Antennas (U) . . . . .	217
46	Generic Support Geometry (U) . . . . .	218
47	EATS and APATS Antennas with MK-4 RV Telemetry (U) . . . . .	219
48	EATS and APATS Antennas with MK-12A RV Telemetry (U) . . . . .	220
49	KMR Mid-Atoll Corridor (U) . . . . .	222
50	Marshall Islands Population Density and Distribution Assumption (U) . . . . .	225
51	MINUTEMAN III Target Penalty for Bigej Repopulation (U) . . . . .	226
52	MX Target Penalty for Bigej Repopulation (U) . . . . .	227
53	Bigej Repopulation Considerations (U) . . . . .	230

# UNCLASSIFIED

## TABLES (U)

1	Summary of Instrumentation Functional Requirements for Air Force Program Test Support (U) . . . . .	10
2	Summary of Instrumentation Functional Requirements for Army BMD Program Test Support (U) . . . . .	16
3	Summary of Instrumentation Functional Requirements for Navy FBM Program Test Support (U) . . . . .	21
4	Strategic Systems Tests Terminal Area Usage (U) . . . . .	30
5	Average Number of MX IRVs Annually by Terminal Area (U) . . . . .	33
6	Summary of Political Events at KMR (June to September 1979) (U) . . . . .	52
7	ITA Driving Requirements for Air Force, Army, and Navy Programs (U) . . . . .	57
8	Island Evaluation for ITA Alternative to KMR (U) . . . . .	59
9	Estimated Cost of Reactivation of MINUTEMAN Complex 31/32 at ESMC (U) . . . . .	63
10	Preliminary Facilities and Environmental Assessment at NMI (U) . . . . .	67
11	Alternate Pacific ITA Costs (U) . . . . .	78
12	Baseline ARIA Test Events (Upgraded Nose Dish) (U) . . . . .	89
13	ARIA Flight Scenarios (U) . . . . .	90
14	Upgraded ARIA Support Requirements--Flight Hours (U) . . . . .	91
15	Upgraded ARIA Support Requirements--Aircraft Days (U) . . . . .	92
16	Upgraded ARIA Support Requirements--Crew Per Diem Days (U) . . . . .	93
17	ARIA Fleet Cost Elements (U) . . . . .	95
18	ARIA Alternative Fleet Life-Cycle Costs (U) . . . . .	95
19	P-3C SMILS Support Requirements--Missions (U) . . . . .	99
20	P-3C SMILS Flight Scenarios (U) . . . . .	100
21	P-3C SMILS Support Requirements--Flight Hours (U) . . . . .	101
22	P-3C SMILS Support Requirements--Aircraft Days and Crew Days (U) . . . . .	102

# UNCLASSIFIED

## TABLES (Continued) (U)

23	P-3 Fleet Cost Elements (U) . . . . .	104
24	URIA Functional Support Requirements (U) . . . . .	109
25	URIA Study Options, Fleet Sizes, and Mission Support Roles (U) . . . . .	113
26	Fleet Size Estimates (U) . . . . .	116
27	URIA Option Payload Summary (U) . . . . .	118
28	Preliminary Platform Cost and Performance Screening (U) . . . . .	120
29	Summary of Fleet Configurations for Options I-VII (U) . . . . .	125
30	Work Breakdown Structure: Cost Items Required for URIA Options (U) . . . . .	126
31	Flight Hours and Crew Per-Diem Days Per Aircraft Support Event (U) . . . . .	128
32	P-3A/B EATS Support Requirements: Aircraft Events, Flight Hours, and Crew Per-Diem Days (U) . . . . .	129
33	Workload Summary--URIA Options (U) . . . . .	130
34	URIA Options--Nonrecurring Design and Investment Costs (U) . . . . .	132
35	Recurring Cost Factors (U) . . . . .	133
36	URIA Option Cost Summary (U) . . . . .	135
37	Effect on Flying Hour Costs for POL Increase of 50% (U) . . . . .	138
38	Tests of Sensitivity of Life-Cycle Costs to Changes (U) . . . . .	138
39	URIA Option Comparisons and Ranking (U) . . . . .	140
40	Budgetary Cost Streams--Option IV (U) . . . . .	145
41	Budgetary Cost Streams--Option VII (U) . . . . .	146
42	TRIDENT (C-4) Scenario For Atlantic TASS at C18 (U) . . . . .	161
43	Baseline ARIS Support Requirements--Missions (U) . . . . .	162
44	Baseline ARIS Support Requirements--Ship Days (U) . . . . .	163
45	Baseline ARIS Costs (U) . . . . .	167

# UNCLASSIFIED

## TABLES (Concluded) (U)

46	Variable Per-Mission Ship Costs: Baseline ARIS (U) . . . . .	168
47	DOT Installation Plan (U) . . . . .	172
48	NAVOCEANO/Commercial Ship Costs (U) . . . . .	175
49	Variable Per-Mission Ship Costs: Alternate Ship Fleet (U) . . . . .	176
50	Composition and Technical Comparisons of SLTA Options (U) . . . . .	183
51	Cost Data for Scoring Support of KMRN Events (U) . . . . .	198
52	Estimated MX Launches into KMRN (U) . . . . .	198
53	K-BOAT Costs (U) . . . . .	202
54	Aircraft Support Events at BOA-1 and -2 With and Without SLTA (U) . . . . .	212
55	Cost Data for SLTA (U) . . . . .	213
56	Army Program Requirements (U) . . . . .	229

# UNCLASSIFIED

## GLOSSARY

ABRES	Advanced Ballistic Reentry System
ADI	air deployed interrogator (buoy)
AFSC	Air Force Systems Command
AGC	automatic gain control
AIS	Airborne Instrumentation System
ALCM	air-launched cruise missile
ALCOR	ARPA-Lincoln C-band Observables Radar
ALTAIR	ARPA Long-Range Tracking and Instrumentation Radar
ANT	Advanced Noretip Technology (Program)
AOOC	Air Operations Control Center
APATS	ARIA Phased-Array Telemetry System
ARIA	Advanced Range Instrumentation Aircraft
ARIS	Advanced Range Instrumentation Ship
ARPA	Advanced Research Projects Agency (now DARPA, Defense ARPA)
A-S	air-to-surface
ASPS	acoustic ship positioning system
ASW	antisubmarine warfare
ATA	Adjunct Terminal Area
AWACS	Airborne Warning and Control System
BET	best estimate of trajectory
BMD	ballistic missile defense
BMDATC	Ballistic Missile Defense Advanced Technology Center
BMDSCOM	Ballistic Missile Defense System Command
BMO	Ballistic Missile Organization
BOA	broad ocean area
BOAST	Broad Ocean Area Scoring and Telemetry
CATS	Caribou aircraft telemetry system
CCAFS	Cape Canaveral Air Force Station
CINCPAC	Commander-in-Chief, Pacific (USN, USA, USAF)

# UNCLASSIFIED

## GLOSSARY (Continued)

CONUS	continental United States
CPR	Chinese People's Republic
D <sup>3</sup>	designation, discrimination, and detection
DASO	demonstration and shakeout
DCR	direct cost reimbursement
DDTE	Deputy Director Test Evaluation
DIC	data insertion converter
DMA	Defense Mapping Agency
DME	distance measuring equipment
DoD	Department of Defense
DoI	Department of the Interior
DOT	deep ocean transponder (principal definition) Designating Optical Tracker (Army program)
DT&E	development testing and evaluation
EATS	Extended Area Test System
ELINT	electronic intelligence
ENNK	Endoatmospheric Nonnuclear Kill
ERCS	Emergency Rocket Communication System
ESMC	Eastern Space and Missile Center (Patrick AFB, Florida)
ETR	Eastern Test Range
FBM	fleet ballistic missile
FM	frequency modulation
FOC	full operating capability
FROCC	Forward-Range Operations and Control Center
FTS	fiscal year
GLCM	Ground-Launched Cruise Missile
GOM	Government of the Marshall Islands
GPS/MAE	Global Positioning System missile accuracy evaluator
G/T	antenna gain divided by total system noise temperature (dB/K)

# UNCLASSIFIED

## GLOSSARY (Continued)

HATS Helicopter Airborne Telemetry System  
HEL high-energy laser  
HF high frequency  
HITS Hydroacoustic Impact Timing System  
HOE Homing Overlay Experiment  
HQSAC Headquarters, Strategic Air Command  
IAP improved accuracy program  
ICAO International Civil Aviation Organization  
ICBM intercontinental ballistic missile  
ICC Instrumentation Computer Center  
IFLOT intermediate focal length optical tracker  
IIP instantaneous impact prediction  
I&M improvement and modernization  
INS Inertial Navigation System  
IOC initial operating capability  
IOT&E initial operational test and evaluation  
IIP instantaneous impact position  
IR infrared  
IRBM intermediate range ballistic missile  
IRS interim recovery system  
IRV instrumented reentry vehicle  
ISA Internal Security Affairs  
ITA instrumented terminal area  
ITCS integrated target control system  
K-BOAT Kwajalein Broad Ocean Area Tug  
KMR Kwajalein Missile Range  
KMRD Kwajalein Missile Range Directorate, BMDSCOM-R, Huntsville, Alabama  
KMRN Kwajalein Missile Range North  
KREMS Kiernan Reentry Measurement System  
KRSS Kwajalein Range Safety System  
LBRV Large Ballistic Reentry Vehicle



~~CONFIDENTIAL~~

## GLOSSARY (Continued)

LBTS	Land-Based Telemetry System
LCC	life-cycle cost
LF	launch facility
LHC	left-hand circular (polarization)
LOAD	Low-Altitude Defense
LORANMONSTA	long-range radio navigation monitoring station
LP	launch point
LWIR	long-wave infrared
MCA	Military Construction Army
MDPS/MSS	multi data processing system/missile safety system
MFC	Missile Flight Control
MILCON	military construction
MILS	Missile Impact Location System
MMS	Multistatic Measurement System
MMW	millimeter wave
MRTFC	Major Range Test Facility Council
MX	Missile X
NASA	National Aeronautics and Space Administration
NFL	new foreign launch
NNK	nonnuclear kill
O&S	operations and support
ONS	Omega Navigation System
OPTI	on-top position indicator
OT	operational test
OT&E	operational test and evaluation
OUSDRE	Office of the Undersecretary of Defense Research and Engineering
PACAF	Pacific Air Force.
PEM	Program Evaluation Missile

~~CONFIDENTIAL~~

~~CONFIDENTIAL~~

GLOSSARY (Continued)

PENAIID penetration aid  
PGI Palisades Geophysical Institute  
  
PILATS Portable Impact Location and Telemetry System  
PIMR Phoenix Islands Missile Range  
PME(E) prime mission electronic (equipment)  
PMTC Pacific Missile Test Center, Point Mugu, California  
POL petroleum, oil, and lubricant  
POPS precision optics pedestal system  
PRF pulse repetition frequency  
R&D research and development  
RADOTS Recording and Digital Optical Tracking System  
RCS radar cross-section  
RE reengine  
RF radio frequency  
RHC right-hand circular (polarization)  
RV reentry vehicle  
SAC Strategic Air Command  
SADOTS Splash-Activated Deep Ocean Transponder System  
SAILS SADOT Acoustic Impact Location System  
SALT Strategic Arms Limitation Treaty  
SATRACK satellite tracking  
SBC spectral ballistic camera  
SDR splash detection radar  
SINS Ship's Inertial Navigation System  
SIOP Single Integrated Operational Plan  
SLBM submarine-launched ballistic missile  
SLEP ship life extension program  
SLTA supplemental land terminal area  
SMILS Sonobuoy Missile Impact Location System

~~UNCLASSIFIED~~  
UNCLASSIFIED

~~CONFIDENTIAL~~

# UNCLASSIFIED

## GLOSSARY (Continued)

SMR	Signature Measurements Radar
S/N	signal-to-noise ratio
SPADATS	Space Detection and Tracking System
SRAM	short-range attack missile
S-S	surface-to-surface
SSTS	Strategic Systems Test Support
SSTSS	Strategic Systems Test Support Study
STP	Systems Technology Program
STREP	Systems Technology Reentry Program
STS	Space Transport System
TAA	telemetry acquisition antenna
TACCO	Tactical Coordinator Console
TARGOP	target optimization
TASA	terminal area support aircraft
TASS	terminal area support ship
T&E	test and evaluation
TDMIS	telemetry Doppler multistatic measurement system
TMIG	telemetry inertial guidance
TOO	target of opportunity
TOS	time on station
TRADEX	Target Resolution and Discrimination Experiments
TSP	test support position
TTPI	Trust Territory of the Pacific Islands
TTS	Transportable Telemetry System
TW	Test Wing
TWT	traveling-wave tube
UHF	ultra-high frequency
URIA	Universal Range Instrumentation Aircraft
U.S.	United States
USCG	United States Coast Guard

# UNCLASSIFIED

## GLOSSARY (Concluded)

USNS United States Naval Station  
VAFB Vandenberg Air Force Base, California  
VHF very high frequency  
VIIP instantaneous impact prediction velocity  
WBS work breakdown structure  
WPAFB Wright-Patterson Air Force Base, Ohio  
WSMC Western Space and Missile Center  
WSMR White Sands Missile Range, New Mexico  
WTR Western Test Range

# UNCLASSIFIED

## I INTRODUCTION AND BACKGROUND (U)

### A. Introduction (U)

(U) This is the second of three volumes documenting the results of the Strategic Systems Test Support Study (SSTSS). Volume II contains the substantiating data and analyses to support the conclusions, recommendations and development planning presented in Volume I, Executive Summary. Three appendices outlining specific test support requirements constitute Volume III of this report. The SSTSS Final Report was prepared by SRI International for the SSTSS Ad Hoc Executive Committee and reflects the consolidated opinions and guidance of that triservice group.

(U) Besides the SSTSS Final Report, two other reports were prepared by SRI International within the SSTSS purview. These reports cover special tasks assigned to SRI for independent analysis: (1) the Universal Range Instrumentation Aircraft (URIA) study, and (2) the comparative analysis of the Extended Area Test System (EATS) and the Advanced Range Instrumentation Aircraft (ARIA) Phased-Array Telemetry System (APATS) in A Ballistic Missile Terminal Area Support Role. The results of these SRI studies are summarized in this volume, and their impacts are factored into related SSTSS topics on mobile resource recommendations. Also, a separate task report<sup>1\*</sup> by the Western Space and Missile Center (WSMC), Vandenberg Air Force Base (VAFB), California and the Kwajalein Missile Range Directorate (KMRD) of the Ballistic Missile Defense System Command (BMDSCOM-R) addresses the repopulation of Bigej Island in the Kwajalein Mid-Atoll Corridor.

---

\* (U) References are listed at the end of this report.

# UNCLASSIFIED

## B. Background (U)

(U) In 1979, a number of factors involved major decisions in the Strategic Systems Test Support (SSTS) resource development and planning for the near term and through the turn of the century. These factors included:

- (U) The need for an alternative to the Kwajalein Missile Range (KMR) as a contingency against any future problems in continued use agreements with the Marshallese government.
- (U) The nation's aging mobile instrumentation aircraft and ship resources used to support strategic system testing.
- (U) Concern for effective coordination between new triservice programs as to test support resource needs.
- (U) The potential offered by new technology for future test operations.

(U) On 2 October 1979 Office of the Undersecretary of Defense Research and Engineering/Deputy Director Test Evaluation (OUSDRE/DDTE) issued a tasking letter to the services to structure a triservice ad hoc group that would define and implement a study to investigate and resolve the concerns for a coordinated and economically effective plan for future strategic system test support. On 27 November 1979 the SSTS group was formed to address the problem. The members of the Ad Hoc Executive Committee were:

- (U) Col Edward P. Miller (Retired October 1980), ESMC/RO, Chairman (November 1979 - June 1980).
- (U) Dr. James A. Means, SAMTO/CA, Chairman (June 1980 - September 1981).
- (U) Mr. Vincent J. Prestipino, NAVAIRSYCOM, Cochairman (November 1979 - September 1981).
- (U) Dr. Charles D. Smith, BMDSCOM/RS, Cochairman (November 1979 - September 1981).

# UNCLASSIFIED

(U) Organizations participating as a Working Group were as follows:

<u>Agency</u>	<u>Principal Representative(s)</u>
Navy, PMTC	CDR. R. McConnel Mr. R. Nifong Mr. R. Carr
Air Force 4950th Test Wing	Lt. Col D. Hopkins (Ret) Mr. C. Coombs Mr. J. Bell
Army BMDSCOM-R	Mr. B. Davis Mr. D. Strietzel Mr. R. Green Mr. J. Millican
WSMC/XR	Maj. R. Boller Mr. K. George
WSMC/ROPB	Mr. E. Ehram Mr. D. Cherry
ESMC/RSN	Mr. C. Miller
Navy SSPO	Capt. W. Bandcroft Mr. M. E. Rasmussen
AFTEC	Lt. Col M. Bolderick Capt. J. Finn
TRW	Mr. R. Herzog
BMO/ENNC	Maj. L. Sandlin
SAC/XPQO	Maj. R. Shankel
HQ USAF/RDPT	Lt. Col T. Kempster
AFSC/TEUP	Maj. J. Koletty
SAMTO/RS	1st Lt. R. Hassan
APL/JHU	Mr. R. Buckman
Kentron/Huntsville	Mr. C. Dobson Mr. G. Davis Mr. W. Densford
-	
Federal Electric Corporation	Mr. E. Hall Mr. R. Pickett Mr. F. Matthews

(U) SRI International, Menlo Park, California, was contracted to analyze support requirements both technically and economically and to consolidate and publish the findings in a final report.

# UNCLASSIFIED

## C. Study Objectives, Approach, and Assumptions (U)

### 1. Charter Tasking (U)

(U) The original SSTSS objectives were to provide recommendations and planning regarding specific topics in the original OUSDRE/DDTE tasking letter. These original task topics were:

- (U) Alternative terminal areas to KMR
- (U) Aging mobile aircraft and ship resources
- (U) New technology applications
- (U) Cross-service program coordination
- (U) Implementation planning.

(U) Approximately midway through the study, several other issues arose that required additional tasks be assigned to the Working Group. These additional tasks extended the period of study from approximately 12 to 18 months. The additional task topics were:

- (U) Technical and economic aspects of a URJA.
- (U) Comparative analysis of the EATS and APATS telemetry system for SSTSS.
- (U) Potentials for repopulation of Bigej Island (Kwajalein Atoll).
- (U) Pacific utilization: intercontinental and submarine - launched ballistic missile (ICBM/SLBM) testing and support aircraft staging.
- (U) Advisability of replacing ARIA EC-135Ns with 707-320Cs.



# UNCLASSIFIED

(U) Concerns over the cost of continued operation of our existing ship and aircraft mobile instrumentation resources were developing because of significant investments required in both categories. The Advanced Range Instrumentation Ships (ARISs), used principally for terminal area support for the Navy's Fleet ballistic missile (FBM) programs, are World War II vessels and in need of major ship life extension programs (SLEPs). The ARIAs (EC-135Ns), used not only for FBM support but also as a worldwide mobile instrumentation capability for other tactical and space programs, are increasingly expensive to maintain and exhibit severe deficiencies in meeting time-on-station requirements at some remote test support locations. Also, increasing noise and pollution standards imposed by the International Civil Aviation Organization (ICAO) will bring additional pressure on these worldwide aircraft operations. The EC-135N ARIAs thus require a major airframe or reengine upgrade to fulfill future strategic system support requirements.

(U) The exploitation of new technology was also to be included in alternative test support concepts considered by the SSTSS. This topic was not pursued at great length, however, as no national space and satellite programs were identified that offered obvious potential impact on SSTS concepts, except for the Global Positioning System (GPS) program, which is applicable to ballistic missile impact scoring.

(U) Cross-service coordination for major strategic system programs was identified as an area of concern by the DoD principally because of new ICBM/FBM (MX and TRIDENT) development and operational testing to begin in the Pacific in the early 1980s. The task for the SSTSS was to investigate these program requirements and to ensure that joint-program test resource needs were coordinated to minimize the development of redundant support assets.

(U) Implementation planning was to recommend a resource development schedule to indicate how existing resources would evolve into a preferred cost-effective posture. This task included identifying the nonrecurring investments required and the recurring annual cost streams.

[REDACTED]

## UNCLASSIFIED

(U) The task areas added to the initial tasking were in response to questions and issues that developed during the study.

(U) The need for a special URIA study arose as the number of options to consolidate test support functions on fewer instrumentation aircraft increased. The baseline aircraft assets considered in this URIA task included the current eight<sup>\*</sup> ARIA; two P-3C reentry vehicle scoring aircraft at VX-1, Patuxent River, for the Atlantic; three additional P-3 scoring aircraft needed for the Pacific; plus the four planned EATS P-3s at the Pacific Missile Test Center (PMTC) in California. Reconfiguring and consolidating these seventeen aircraft into a smaller, more effective fleet could offer substantial savings to the nation. This task was assigned to SRI International under the guidance of a URIA study group chaired by 1st Lt. R. Hassan of SAMTO.

(U) The task of comparing two airborne phased-array telemetry antenna systems, EATS and APATS, in the ICBM/FBM terminal area support role was closely related and in support of the URIA study. This was because both the Air Force (AFSC/ESD) and the Navy (PMTC) were developing separate multibeam phased-array telemetry systems having potential redundancy, although the systems were being developed for different applications (the Navy's EATS, and the Air Force's APATS). This task was also given to SRI for action and documentation in a separate report.<sup>2</sup>

[REDACTED]

# UNCLASSIFIED

(U) The task areas added to the initial tasking were in response to questions and issues that developed during the study.

(U) The need for a special URIA study arose as the number of options to consolidate test support functions on fewer instrumentation aircraft increased. The baseline aircraft assets considered in this URIA task included the current eight\* ARIA; two P-3C reentry vehicle scoring aircraft at VX-1, Patuxent River, for the Atlantic; three additional P-3 scoring aircraft needed for the Pacific; plus the four planned EATS P-3s at the Pacific Missile Test Center (PMTC) in California. Reconfiguring and consolidating these seventeen aircraft into a smaller, more effective fleet could offer substantial savings to the nation. This task was assigned to SRI International under the guidance of a URIA study group chaired by 1st Lt. R. Hassan of SAMTO.

(U) The task of comparing two airborne phased-array telemetry antenna systems, EATS and APATS, in the ICBM/FBM terminal area support role was closely related and in support of the URIA study. This was because both the Air Force (AFSC/ESD) and the Navy (PMTC) were developing separate multibeam phased-array telemetry systems having potential redundancy, although the systems were being developed for different applications (the Navy's EATS, and the Air Force's APATS). This task was also given to SRI for action and documentation in a separate report.<sup>2</sup>

(U) The question of repopulation of Bigej Island, a small islet in the Kwajalein Atoll, arose during recent negotiations with the Marshallese government. Bigej is located just within the Mid-Atoll Corridor (near Meck) used for ballistic missile defense (BMD) and ballistic missile testing at KMR. This task was addressed by the SSTSS Working Group to assess the impact and advisability of permitting native repopulation of Bigej. This task was performed by KMRD, BMDSCOM-R, Huntsville, Alabama, and the WSMC Safety Office, VAFB, California and is documented in detail in a special report<sup>1</sup> issued by BMDSCOM-RS. The results are summarized in this SSTSS Final Report.

---

\* (U) One EC-135N ARIA was lost in an accident on 6 May 1981. This loss did not affect the study findings.

# UNCLASSIFIED

(U) The Pacific utilization tasks evolves from the State Department's interest in the planning for the testing of the Missile X (MX) system in the Pacific. These interests stemmed from continuing foreign relationships with the various governments that might have concern or be involved in missile impact areas or trajectory overflights, and that could grant permission for support-aircraft stagings from airfields within their jurisdiction. The results of this task were briefed to the Department of Defense/Internal Security Affairs (DoD/ISA) and the Department of State on two occasions (February/March 1981), and to Pacific Air Force/Commander in Chief, Pacific (PACAF/CINCPAC) on April 1981.

X  
dead  
rept!

(U) The last of the additional tasks involved the need for an early insight into the advisability of the government's purchase of used commercial 707-320C aircraft, which were prime candidates for replacement of the aging ARIA EC-135N aircraft. The affirmative answer was provided to the DoD in April 1981.

## 2. Study Approach and Assumptions (U)

(U) The approach to the SSTSS was agreed upon by the Executive Committee at the outset of study. Initially the study was defined in three phases involving the following elements:

- (U) Phase I--Identify range user (program) requirements:
  - Assess current support resource capability
  - Identify deficiencies in current assets
  - Identify alternative support concepts.
- (U) Phase II--Evaluate alternatives and select best approach:
  - --Perform technical and economic comparisons
  - Develop life-cycle costs (LCCs) and schedules for preferred alternatives.
- (U) Phase III (Initial)--Develop implementation plan.

# UNCLASSIFIED

- (U) Phase III (Revised)--Develop further alternatives and an implementation plan:
  - Develop URJA alternatives
  - Perform EATS/APATS analysis
  - Study Bigej repopulation
  - Determine Pacific utilization approach
  - Develop conclusions and recommendations
  - Define schedules and milestones.

(U) At the study outset, the following necessary assumptions were adopted:

- (U) Any SSTSS alternative should satisfy user requirements at least as well as the existing baseline resources. Also, any driving user requirement that heavily influenced an SSTSS alternative could be challenged.
- (U) Cost to the nation was a primary consideration, rather than just user-reimbursable costs.
- (U) When two or more alternatives were being considered, the solution with the least technical risk would be preferred.
- (U) The direct cost reimbursement (DCR) policy, which has been in effect for a number of years, would continue throughout the period to be studied (1982 through 2000).

# UNCLASSIFIED

## II REQUIREMENTS DEFINITION FOR STRATEGIC SYSTEM TEST SUPPORT (U)

(U) Section II summarizes the baseline technical requirements and test schedules employed by the SSTSS Working Group to develop workloads and alternative SSTS configurations.

### A. Summary of Technical Requirements (U)

(U) Detailed descriptions of the test support requirements for the Air Force Ballistic Missile Organization (BMO), Army BMDSCOM, and Navy FBM programs were provided by the individual program offices and are presented in Appendices A through C of this report (Volume III). Summaries of those technical requirements are presented below.

#### 1. Air Force Ballistic Missile Programs (U)

(U) The Air Force programs requiring SSTS have been identified as:

- (U) MX Flight Tests--Development testing and evaluation (DT&E) and initial operational test and evaluation (IOT&E).
- (U) MX Post-Initial Operating Capability (IOC)--Operational test and evaluation (OT&E).
- (U) MINUTEMAN II OT&E.
- (U) MINUTEMAN III OT&E.
- (U) Advanced Ballistic Reentry System (ABRES) research and development (R&D).

The functional support requirements for the testing of these Air Force programs are summarized in Table 1. Support requirements have been separated into those required at midcourse and in the terminal areas. Terminal area requirements have been further separated into those required in an instrumented terminal area (ITA), such as the Kwajalein Missile Range (KMR), and those required in a broad ocean area (BOA).

Table 1

(U) SUMMARY OF INSTRUMENTATION FUNCTIONAL REQUIREMENTS FOR AIR FORCE PROGRAM TEST SUPPORT

Program	Midcourse						Terminal Area														
							ITA							BOA							
	Metric	Tele-metry	Radar Sig-nature	Optics	Meteo-ology	Data Relay	Metric	Tele-metry	Scoring	Radar Sig-nature	Optics	Recovery	Meteo-ology	Data Relay	Metric	Tele-metry	Scoring	Radar Sig-nature	Optics	Meteo-ology	Data Relay
MX Flight Tests (DT&E)	--	--	--	--	--	--	(1)	X	X	--	(2)	--	X	(7)	--	X	X	--	(2)	(3)	(7)
MX Post-IOC (OT&E)	--	--	--	--	--	--	(1)	X	X	--	(2)	--	X	(7)	--	X	X	--	(2)	(3)	(7)
MINUTEMAN II MK-11C OT&E	(3)	--	--	--	--	--	X	--	X	X	X	X	X	--	--	--	--	--	--	--	--
MINUTEMAN III OT&E	--	--	--	--	--	--	X	X	X	(4)	(2)	--	X	--	--	--	--	--	--	--	--
ABRES R&D	--	--	--	--	--	--	X	X	--	(5)	(5)	(6)	X	--	--	--	--	--	--	--	--

## NOTES:

-- Not required

X Required

(1) Required only if readily available, for example at KMR

(2) Streak photography

(3) Desired for accuracy assessment

(4) Required for PENAID launches only

(5) Complex signatures

(6) Generally not required, except IRS, LBRV

(7) Desired post-real time, if cost effective

UNCLASSIFIED

UNCLASSIFIED

10

UNCLASSIFIED

(U) MINUTEMAN II OT&E is scheduled to continue with launches from VAFB to KMR. There are two major types of MINUTEMAN II launches: those with MK-11 test RVs targeted for the Kwajalein Lagoon, and those with Emergency Rocket Communications System (ERCS) payloads targeted for a BOA (the primary purpose is to test the ERCS transmitter in a flight environment, which requires no terminal area support). Normally, one MK-11 launch per year will employ PENAIDs. Midcourse metric data for accuracy assessment of MK-11 RVs are obtained from Hawaii-based instrumentation. All launches into the ITA require metric, scoring, optics, and meteorological data. Radar signature data are also required when PENAIDs are carried. Since the MK-11 RVs do not carry a telemetry package, shallow water recovery of the RV instrumentation package is required, thus precluding the use of a BOA for the MINUTEMAN II OT&E program.

(U) MINUTEMAN III OT&E tests are scheduled to continue with launches from VAFB to the Kwajalein Lagoon. No midcourse requirements have been identified for this program. Land impact will be required for some launches to test fusing techniques. In addition to meteorological data, multiple-object metric, telemetry, scoring, and optic data are required of all launches into the ITA. Complex radar signature data in the ITA

\* (U) GPS-MAE: Global Positioning System missile accuracy evaluator: an on-board metric measurement system being evaluated by the Air Force. This program has been recently deleted.

OT:  
operational  
testing.



# UNCLASSIFIED

(U)

are required for those launches carrying PENAIDs. Since all launches have been scheduled into the KMR ITA, no BOA requirements have been identified for MINUTEMAN III.

(U) The ABRES program, which involves the research and development of new reentry systems, launches from VAFB, using modified MINUTEMAN I boosters, to the KMR terminal area for acquisition of metric tracking, complex radar and optic signatures, telemetry, and reentry environmental data. Telemetry reception of the deployment functions is desired at midcourse and is currently provided from land based facilities in Hawaii. Continued ABRES program funding is currently questionable; it is assumed, however, that R&D on new reentry systems will continue in the future. The ABRES program is currently being reviewed by OUSDRE.

*Advanced  
Ballistic  
Re-entry  
System.*

## 2. Army Ballistic Missile Defense Programs (U)

(U) The Army BMD programs requiring SSTS have been identified as:

- (U) Designating Optical Tracker (DOT).
- (U) Ground-Based Optics.
- (U) Low-Altitude Discrimination.
- (U) ALCOR Millimeter Wave (MMW) Augmentation.
- (U) Multistatic Discrimination.
- (U) Optical Aircraft Measurements.
- (U) Homing Overlay Experiments (HOE).
- (U) Optics Adjunct.
- (U) Signature Measurement Radar.
- (U) Low-Altitude Defense (LoAD).
- (U) Endoatmospheric Nonnuclear Kill (ENNK) Technology Development.
- (U) Rapid Deployment.
- (U) PERSHING II.
- (U) Shuttle Experiments (non-Army, KMR-supported).
- (U) Space Detection and Tracking System (SPADATS) (non-Army, KMR-supported).

# UNCLASSIFIED

# UNCLASSIFIED

(U)

All programs except PERSHING II and SPADATS are technology development programs to detect and intercept incoming RVs, and they therefore require targets of opportunity (TOOs) from other ballistic missile programs. For that reason, Army BMD programs are under development at KMR to take advantage of the availability of TOOs. Detailed descriptions of the Army BMD programs can be found in Appendix B. *targets of opportunity*

(U) The functional requirements for the testing support of these programs are summarized in Table 2. In some cases, midcourse information is required of the TOO for target designation or handover to the BMD system. These data are generally obtained with Hawaii-based systems, often as part of the supporting data for the program providing the TOO. Support requirements in the ITA have been separated in Table 2 to distinguish the data required from the TOO and from the BMD interceptor.\* KMR is currently employed as the ITA for all BMD programs. These BMD programs have not indicated any requirement for national mobile instrumentation resources, such as ARIA or range ships.

(U) The DOT missions are designed to obtain data fundamental to long-wave infrared (LWIR) exoatmospheric BMD functions, including designation and tracking with realistic test conditions (target, geometry, and environment). The DOT probes are scheduled to be launched from Roi Namur (KMR) toward TOOs provided by other test programs entering the KMR terminal area. Tracking of the TOO is required at midcourse to provide handover information to DOT; midcourse telemetry data are required to monitor the TOO deployment functions. Metric data of both the TOO and DOT probes are required in the ITA. Complex radar signature, optical signature and documentation of the TOO, telemetry from the DOT probe, and meteorological data are required in the ITA.

*[has another (Army) meaning here - not sub.]*

*BMD & Deep Ocean Transponder Tests*

*TOO Target of Opportunity*

\* (U) Although PERSHING II is not a BMD program, it has been listed in Table 2 as a TOO for presentation in a common format.

# UNCLASSIFIED

Table 2

(U) SUMMARY OF INSTRUMENTATION FUNCTIONAL REQUIREMENTS FOR ARMY BMD PROGRAM TEST SUPPORT  
(Midcourse and ITA)

Program	Midcourse (100)						ITA (Interceptor)								ITA (TOO)							
	Metric	Tele-metry	Radar Signature	Optics	Meteo-ology	Data Relay	Metric	Tele-metry	Scoring	Radar Signature	Optics	Recovery	Meteo-ology	Data Relay	Metric	Tele-metry	Scoring	Radar Signature	Optics	Recovery	Meteo-ology	Data Relay
Designated Optical Tracker	(1)	X	--	--	--	X	X	X	--	--	--	(2)	X	X	X	--	--	X	X	--	X	X
Ground-Based Optics	(1)	--	--	--	--	X	--	--	--	--	--	--	X	X	(1)	--	--	--	(3)	--	X	X
Shuttle Experiments	--	X	--	--	--	--	--	--	--	--	--	--	--	--	--	--	--	--	--	--	--	--
Low-Altitude Discrimination	--	--	--	--	--	--	--	--	--	--	--	--	--	--	X	X	--	(3)	(3)	--	X	X
AICOR BMD Augmentation	--	--	--	--	--	--	--	--	--	--	--	--	--	--	X	--	--	(3)	(3)	--	X	--
Multistatic Discrimination	--	--	--	--	--	--	--	--	--	--	--	--	--	--	X	--	--	(3)	(3)	--	X	X
Optical Aircraft Measurements	(1)	--	--	--	--	--	(1)	--	--	--	--	--	--	--	X	--	--	X	X	--	--	--
Homing Overlay Experiment	(1)	X	--	--	--	X	X	X	(4)	--	--	X	X	X	X	X	(4)	(3)	(3)	--	X	X
Optics Adjunct	--	--	--	--	--	--	X	X	--	--	--	--	X	X	--	--	--	--	--	--	X	X
Signature Measurement Radar	--	--	--	--	--	--	--	--	--	--	--	--	X	--	(1)	--	--	(1)	(1)	--	X	--
Low-Altitude Defense (LoAD)	(1)	X	--	--	--	X	(1)	X	(4)	--	(5)	--	X	X	(1)	X	(4)	--	(5)	--	X	X
ENNK	--	--	--	--	--	--	X	X	(4)	--	(5)	X	X	--	X	X	(4)	--	(5)	X	X	--
Rapid Deployment Programs	--	--	--	--	--	--	X	--	(4)	--	(5)	X	--	X	X	--	(4)	--	(5)	--	--	X
PERSHING (considered as TOO)	(6)	(6)	--	--	X	--	--	--	--	--	--	--	--	--	(6)	(6)	--	--	--	--	--	--

NOTES: -- Not required

X Required

(1) Pointing data, handover

(2) Sensor recovery required

(3) Signature data for correlation

(4) Kill assessment, miss distance

(5) Documentary optics

(6) PERSHING metric and telemetry can be performed by land-based assets near Atlantic

UNCLASSIFIED

# UNCLASSIFIED

(U) The Ground-Based Optics program is being developed at KMR to obtain infrared (IR) and laser data bases and to demonstrate sensor functions. The only midcourse support required of this program is the acquisition of pointing data on the T00 to provide handover to the Ground-Based Optics sensors. Pointing data for the optic system are also required in the ITA. Optical signatures of the T00 are required in the ITA for correlation with the performance of the Ground-Based Optics sensors; meteorological data are required to complete the documentation.

(U) The Shuttle Experiments will be carried into orbit by the Space Transport System (STS) and will include contamination, signature, and background measurements; deployable optics; deployable optics with high-energy laser (HEL); BMD space measurement range; and BMD space pallet sensor utilization. The only support function to be provided by KMR is downlink telemetry collection from the orbiting sensor package. Although the Shuttle program requires telemetry at 16 Mbps, the BMD requirement for KMR is anticipated to be at a lower bit rate.

(U) The Low-Altitude Discrimination program is being developed to determine metric and electromagnetic target signatures at low altitudes, to develop discrimination algorithms, and to evaluate discrimination effectiveness. The program is being developed at KMR and will require close-in targets with various sensor-target aspect angles. Performing tests at low aspect angles necessitates that the "targeted" sensors be located at remote unpopulated sites for safety purposes. There are no midcourse support requirements for this program. Metric and telemetry downlink data are required from the T00 in the ITA. Simple and complex radar and optics signatures of the T00 are required in the ITA for correlation. Standard rawinsonde meteorological data are required in the ITA to document the program events.

(U) The ALCOR MMW Augmentation program is designed to enhance the capabilities of the ALCOR radar at KMR. The augmentation program will provide improved data collection and hardware technology developments. The ALCOR will serve as an acquisition source and processor.

# UNCLASSIFIED

(U)

Support requirements in the ITA include metric, complex radar and optical signatures, and meteorology.

(U) The Multistatic Discrimination program is ongoing at KMR. This program provides improved measurement accuracy on RV signatures, provides a multistatic discrimination data base, and serves as a candidate non-nuclear kill testbed. The program requires no midcourse support; ITA support requirements are similar to those for the ALCOR MMW Augmentation program.

(U) The Homing Overlay Experiments (HOE) are designed to develop an exoatmospheric nonnuclear kill (NNK) capability and to assess NNK lethality. Launches are planned from Meck (KMR) and VAFB. Intercepts are planned at 300-500 nmi from Meck, at 280-nmi altitude, with one at 65-nmi altitude, north-northeast of Meck. Large island complexes are required to support these test geometrics. HOE will require midcourse pointing data and telemetry of the TOO deployment functions to be relayed to KMR. Metric, telemetry, and kill assessment data will be required of the TOO and the interceptor in the ITA. Simple radar signature and optic signature support of the target RV is required in the ITA, as are meteorological data. If a designation, discrimination, and detection (D<sup>3</sup>) program is flown, recovery of the interceptor from the ocean surface will be required.

(U) The Optics Adjunct program is currently unfunded, but proposes to supplement the Optical Aircraft Measurement program by using TOOs entering KMR. There are no midcourse support requirements. Metric

# UNCLASSIFIED

(U)

tracking and telemetry reception of the aircraft and meteorological data will be required in the ITA.

(U) The installation of the Signature Measurement Radar has been proposed for Meck, Illeginni, or Legan at KMR. This radar will gather a data base for the development of discrimination schema in support of the Low-Altitude Defense program. The development of the Signature Measurement Radar program will require low aspect angle TOOs from other programs, which imposes safety constraints requiring remote, unpopulated sensor sites. Midcourse support is not required. Metric data, complex radar signatures, and optics support from other assets at KMR will be required for comparisons. Meteorological data from standard soundings will be used to document the tests.

(U) The Low-Altitude Defense (LOAD) program will be implemented at the White Sands Missile Range (WSMR) and KMR to develop and test low-altitude interceptors and radars. Metric pointing and telemetry support of the interceptor and target vehicles will be required both at midcourse and in the ITA. This program also involves close-in targeting with the attendant safety constraints. Miss-distance scoring, documentary optics, and rocketsonde meteorological support will be required in the ITA.

(U) The Endoatmospheric Nonnuclear Kill (ENNK) Technology Development program proposes to develop the technology base and flight demonstrations to intercept RVs with nonnuclear warheads. Holloman AFB, WSMR, and KMR are currently under consideration for the development of ENNK. ENNK requires TOOs from other programs that provide close-in targeting at unpopulated sensor sites, but no midcourse support requirements have been identified. Impact prediction and miss-distance scoring will be required in the ITA. Debris recovery will be required during the development phase.

(U) The Rapid Deployment programs propose to develop close-in rapid deployment launch and interceptor systems. The targets will be PERSHING missiles launched from Green River to WSMR, with demonstration tests at

# UNCLASSIFIED

Table 3

## (U) SUMMARY OF INSTRUMENTATION FUNCTIONAL REQUIREMENTS FOR NAVY FBM PROGRAM TEST SUPPORT

Program	Midcourse			ITA						BOA					
	Metric	Sig-nature	Tele-metry	Metric	Tele-metry	Sig-nature	Scoring	Optics	Meteoro-logical	Metric	Tele-metry	Sig-nature	Scoring	Optics	Meteoro-logical
<u>Atlantic</u>															
POSEIDON (C-3) DASO	--	--	X	--	X	--	X	--	X	--	X	--	X	--	(4)
POSEIDON (C-3) OT	--	--	X	(3)	X	--	X	(3)	X	--	X	--	X	--	(4)
TRIDENT (C-4) DASO	(2)	--	X	(1)	X	--	X	(1)	X	--	X	--	X	--	(4)
TRIDENT (C-4) OT	(2)	--	X	(1)	X	--	X	(1)	X	--	X	--	X	--	(4)
Advanced TRIDENT (D-5) PEM/DASO/DEV	(2)	--	X	X	X	--	X	X	X	(2)	X	--	X	--	(4)
	--	X	X	X	X	X	X	X	X	--	X	X	X	--	(4)
MK-500 PERAID	--	--	X	X	X	X	--	X	X	--	--	--	--	--	(4)
<u>Pacific</u>															
TRIDENT (C-4) OT	(2)	--	X	--	--	--	--	--	--	--	X	--	X	--	(4)
Advanced TRIDENT (D-5) OT	(2)	--	X	(Not defined)						[Not defined (5)]					

## NOTES:

- (1) IAP launches (Ascension Island)
- (2) Metric data via SATRACK
- (3) Ascension Island
- (4) Data used when available (i.e., from TASS, P-3 standard avionics, air deployed Omegasonde Under Investigation)
- (5) Assumed for SSTSS purposes to be similar to C-4 requirements.

UNCLASSIFIED

FIGURE 3 (U) BASELINE ATLANTIC TERMINAL AREAS

(U)

and at the terminal area, either an ITA or BOA. A maximum of two instrumented reentry bodies must be handled by the S-band telemetry system, either surface or airborne, from 400 kft to impact. Multiple impacts are scored by deep ocean transponders, hard-wired at Antigua and sound-activated by an impacting RV in the BOA impact points.

Requirements for meteorological observations at all impact areas are identical and nominal.

(U) POSEIDON (C-3) Missile System OT will be performed by launches from operational submarines. The intent is to test the missile system throughout its life and to train the submarine crew by launching under "realistic" conditions. Tests are conducted from one of four BOA launch



# UNCLASSIFIED

(U)

areas into one of the three BOA impact points or into the Ascension Island ITA. Various launch azimuths and trajectory ranges are thus available to test the system. The only midcourse instrumentation requirement is telemetry from RV separation plus 30 s. Metric data are required at the Ascension ITA, along with telemetry, impact scoring, optical, and meteorological observations on selected C-3 OT launches. POSEIDON (C-3) OT launches into the BOAs require telemetry (from 400 kft), impact scoring, and meteorological data.

(U) The prime intent of the TRIDENT (C-4) DASO test series is to evaluate the missile system performance and operational readiness; a secondary purpose is to provide submarine crews with operational launch training. The C-4 DASO tests are scheduled to be launched from the Eastern Test Range (ETR) D4 launch area into either the Ascension Island ITA or one of three BOAs. Multiple ranges and azimuths are thus tested. No midcourse instrumentation requirements are specified for C-4 DASO tests. For test flights into the Ascension Island ITA, metric data are required from 250 kft to impact, not only from land-based radars and telemetry systems, but also from mobile instrumentation. The two measurement sources provide a longer measurement base line that permits a more precise measurement of the missile trajectory. Only a single IRV is indicated for C-4 DASO flights; certain flights [MK-4 improved accuracy program (IAP)] into Ascension will require optical tracking plus metric tracking from 400 kft to impact. No metric tracking is required in the BOA impact areas; only telemetry and impact scoring are required. Meteorological data for both ITA and BOA impact areas are nominal. Data relay is also specified but not required in real time.

*Demonstration &  
Shakedown  
Operations  
in  
AO.*

(U) The TRIDENT (C-4) OT program uses the Eastern Test Range, two BOA launch points, one ITA, and four BOA impact points. Two purposes are stated for the C-4 OT program: (1) tactical demonstration of the missile system, and (2) submarine crew training under close-to-realistic conditions. Multiple range and launch azimuth tests will be scheduled, including maximum range launches into C18. Telemetry and scoring are

# UNCLASSIFIED

# UNCLASSIFIED

(U)

required; no metric measurement requirements are indicated for the C-4 OT program. For those IAP launches into the Ascension ITA, there is a requirement to measure the trajectory from pierce point (400 kft) to impact. Telemetry, scoring, and meteorological data requirements are normal, with no optical measurement indicated. Data relay is requested from the impact areas, but this is not a real-time requirement. The BOA impact point tests have the additional requirement of dual RV impact into two different areas. This will require the use of telemetry and scoring instrumentation at each of the impact points.

(U) The TRIDENT (C-4) operational tests <sup>or points ?</sup> into the Pacific BOA impact points use two submarine launch platforms stationed off the California coast. TRIDENT (C-4s) are launched into three BOA impact points, providing multiple range and azimuth trajectories. Figure 4 shows the Pacific BOA locations for TRIDENT prior to Air Force/Navy BOA consolidation. At present, telemetry and scoring at the impact points are required. Meteorological data requirements are minimal, incorporating satellite weather data plus aircraft observations. No data relay is involved. There are no midcourse or ITA technical requirements for the Pacific C-4 OT.

provi =  
"unten" ?

(U) The ADVANCED TRIDENT (D-5) program is in the planning and early development stages. At this point, there are few hard requirements for terminal area (or midcourse) instrumentation. There is a high probability that the early flight tests will approximate C-4 DASO flights, especially those into an ITA. As the program advances, test launches will be predominately into broad ocean impact areas, some of which will certainly be long-range, such as C18. F

established. Most of the tests will be in the Eastern Test Range (Atlantic), with a probable extension into the Pacific during the OT phases.

from vol II

# UNCLASSIFIED

(U) The MK-500 PENAID test program will be launched into the Ascension impact area as part of selected C-4 flights. The MK-500 tests require RCS metric tracking and optical measurements. Existing instrumentation at Ascension Island appears insufficient for the MK-500 metric tracking test requirements, thus the mobile instrumentation radar capabilities may be required to support MK-500 flights at Ascension. At present, all MK-500 flights are planned for the Atlantic. However, a few flights may be directed to Pacific instrumented land impact points, such as the Kwajalein Missile Range.

#### 4. Other Programs (U)

(U) In addition to the strategic systems identified above, a number of other programs employ the same test support assets as do strategic systems. Prominent among these programs are the National Aeronautics and Space Administration (NASA) ETR launches, NASA WTR launches, the Space Shuttle, and other Air Force and DoD satellite programs. The Air-Launched Cruise Missile (ALCM) and Ground-Launched Cruise Missile (GLCM) are also included because of their use of ARIA. Although detailed descriptions of these programs have not been included in this document, the workload created by these programs was considered where they impact the availability of SSTS assets.

# UNCLASSIFIED

## B. Summary of Test Schedules (U)

(U) This section summarizes the baseline test schedule as identified by the program offices for the various programs employing SSTS assets. These schedules are detailed in Appendices A through C of this report. Where available, the annual number of launch events for each program is identified, then the terminal area usage imposed by those launches is discussed.

### 1. Annual Launch Events (U)

(U) A summary of the annual missions requiring SSTS is presented in Figure 5. The solid lines in Figure 5 indicate where firm projections could be provided by the program offices; the dashed lines indicate estimated schedules made by those offices or the SSTSS Working Group. In most cases, the program offices could provide firm estimates only for the next 5 to 10 years and could only assume the programs would continue thereafter. Many Army BMD programs could not estimate an annual number of events, because the programs are dependent on TOOs from other programs.

### 2. Terminal Area Usage (U)

(U) Table 4 shows the terminal area usage (as currently proposed by the program offices and projected by the SSTSS Working Group) to be employed by the launch events cited previously in Figure 1. The locations of the proposed terminal areas were shown graphically in Figures 2 and 3, and the precise latitude and longitude of each can be found in Tables A-1, C-1, and C-2 of Appendices A and C. In Table 4, a single number for a given terminal area and year indicates the annual number of events at that terminal area and that no mobile instrumentation support is anticipated. Where two numbers are shown (e.g., 1/2), the first indicates the number of events, and the second indicates the number of IRVs requiring mobile support. A second number of zero indicates that no IRVs are employed and only impact scoring is required; a second number of one or greater indicates that the IRVs require telemetry monitoring in addition to impact scoring.

*Instrumented  
Re-Entry  
Vehicle.*

# UNCLASSIFIED

(U)

+ Notes to Table 4:

- (1) (U) Launches estimated by the MINUTEMAN II Program Office; no schedule estimated beyond FY86.
- (2) (U) Launches for FY82 and FY83 estimated by the MINUTEMAN III Program Office; launches for FY84-99 by the SSTSS Working Group.
- (3) (U) Launches estimated by the ABRES Program Office; program terminates in FY85.

7.33  
del.

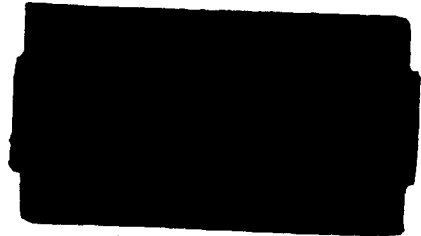

## UNCLASSIFIED

(U)

and any desired midcourse telemetry data are currently obtained from assets in Hawaii when the missiles are targeted to KMR. Midcourse metric data to support the Navy programs are obtained with satellite tracking (SATRACK), and midcourse telemetry is obtained with downrange ships.

(U) The MX and ADVANCED TRIDENT (D-5) missiles and the Army BMD programs impose safety constraints on the selection of ITA locations. Due to the increased dynamics of the MX and D-5 missiles, the test ranges must improve their IIP <sup>instantaneous impact prediction</sup> capability before these missiles can be targeted near populated land masses such as Ascension Island and KMR. The BMD programs impose additional safety constraints on the ITA because of interceptor launches at the TOOs.

p? Island?

8

(U) Consequently, if PI becomes the principal Pacific ITA, then some contingency plan must be available if the MX or TRIDENT programs encounter problems during development or operational testing (or if MX PENAIIDs are developed) and require the diagnostic instrumentation services that can only be provided by a land-based complex. Such a contingency is offered by the split-range posture.

(U) This posture would involve a partial build-up of instrumentation at NMI, such as would be entailed in the first two phases described for the NMI ITA concept. This partial build-up would provide telemetry, optics, and RV scoring for impacts near Farallon de Medinilla. A modest metric/signature capability (Digital Instrumentation Radar), multi-RV telemetry, ballistic cameras, and a range operations center would be deployed on Saipan. This supplemental version of the NMI concept is illustrated in Figure 13.

} x

This page follows p 33, hence regarded as p 34....

UNCLASSIFIED

Why is entire "unclas" p.  
deleted?

Cannot be p 34 . . . . ?  
or is this a "revised"  
sanitation of p 34 ?

UNCLASSIFIED



# UNCLASSIFIED

## III CONSOLIDATED REQUIREMENTS (U)

(U) This section summarizes the principal technical, operational, and logistic requirements to support the strategic systems test programs identified previously. Requirements for instrumented terminal areas are first presented, then the requirements for broad ocean terminal areas.

### A. Instrumented Terminal Areas (ITAs) (U)

(U) There are currently two fixed land-based ITAs: Ascension Island in the Atlantic Ocean and KMR in the Pacific Ocean.

#### 1. Driving ITA Test Support Requirements (U)

(U) The Air Force ICBM test programs impacting on the ITA requirements are MINUTEMAN II, MINUTEMAN III, MX, and ABRES. All Air Force ICBM testing is scheduled to be conducted in the Pacific Ocean with launches from VAFB targeted to KMR when ITA support is required. These programs require terminal areas at distances that provide operational realism for the missile booster range and payload throwweight. MINUTEMAN III requires land impact to test fusing techniques, and MX may require land impact if new fusing techniques are developed for the missile. MINUTEMAN II must impact in shallow water so that the data recording instrumentation package may be recovered, and some of the ABRES tests may require RV recovery.

(U) All Air Force programs using the ITA require metric data to be obtained;

All programs except MINUTEMAN II require telemetry data from IRVs; although there are no excessive data rates associated with the Air Force programs, MINUTEMAN III and MX require multiple object telemetry. All programs except ABRES require scoring; multiple object scoring must be provided for MINUTEMAN III and MX. Radar signature data are occasionally required by MINUTEMAN II, MINUTEMAN III launches carrying

# UNCLASSIFIED

(U)

PENAIDs, MX if new RVs or PENAIDs are developed, and ABRES. ABRES imposes the most demanding signature requirements on the ITA, since complex data suitable for analysis of multifrequency and sophisticated radar processing techniques are required to evaluate the effectiveness of ABRES R&D. All programs require documentary optics; in most cases, simple streak photography (with 50  $\mu$ rad resolution) to document the effects of the reentry environment on the RVs. Simple meteorological data to document the reentry environment are required by all Air Force programs; again any requirements for detailed meteorological data would be imposed by the development of new RVs or PENAIDs under program such as ABRES.

(U) Numerous Army BMD programs are ongoing and are scheduled for development at KMR as discussed in Section II. These programs depend on the availability of TOOs from other programs to provide operational realism during testing. Many of the programs involve interceptor flight tests that impose population safety constraints on the selection of the land-based terminal area. They are further complicated by the requirements for interceptor recovery in many cases. Complex terminal area radar and optical signature data are generally required of the TOO, and simple documentary optics of the interceptor are sometimes required for kill assessment. Low-angle sensor data involving close-in targeting and variable aspect angles are required to support these programs. In summary, many of the instrumentation assets required to support the Army BMD programs are complementary to the Air Force ABRES and other PENAIDs development programs, and when tested at the same ITA are synergistic.

(U) The Navy POSEIDON (C-3), TRIDENT (C-4), and ADVANCED TRIDENT (D-5) programs are scheduled to be targeted from open-ocean launch areas to the Ascension Island ITA. No Navy SLBM launches into a Pacific Ocean ITA are scheduled. The Navy has no RV recovery requirements, and land impact will be required only if new fusing techniques are developed. All Navy improved accuracy programs require metric data to be acquired in the ITA. Multiple-object scoring and telemetry are required. TRIDENT (C-4) and (D-5) have a unique requirement for dual-channel telemetry.

Instrumented  
Terminal  
Area.

from Vol II

(U)

Radar signature data are required only for PENAIIDs development; documentary optics (streak photography) are required for all entries into the ITA. Standard meteorological data are required to document the events in the ITA.

2. Major ITA Considerations (U)

(U) In locating an ITA range from the launch areas, midcourse requirements and safety must be considered.

(U) Midcourse metric data are desired for MINUTEMAN II accuracy-assessment launches. It is also desirable to obtain midcourse metric data and deployment verification on TOOs supporting the Army BMD programs to assist in interceptor target designation. In both cases, these data

# UNCLASSIFIED

## B. Broad Ocean Area Requirements (U)

(U) There are six BOAs in the Atlantic Ocean (C9, C11, C12, C16, and C18) and five in the Pacific Ocean (BOA-1, BOA-2, BOA-3, Oeno, and Wake), (Figures 2 and 3) that are scheduled to support Air Force ICBM and Navy SLBM programs. The Army BMD programs sometimes employ an uninstrumented BOA to support interceptor launches near KMR; however, no specific BOA requirements have been identified for Army programs.

### 1. Driving BOA Requirements (U)

(U) Both the Air Force and the Navy programs are scheduled to employ BOAs to provide range diversity to satisfy the operational realism required by their test programs. The Navy OT also requires azimuth diversity and employs BOAs in both oceans, whereas the Air Force will employ BOAs only in the Pacific Ocean.

Similarly, the Air Force is scheduled to employ two BOAs simultaneously to demonstrate the multiple targeting capability of MX.

(U) All Air Force and Navy programs require telemetry data and RV impact scoring to be obtained in the BOAs as a minimum. Many tests will entail the acquisition of telemetry data from multiple IRVs and scoring of all RVs, instrumented or not. Meteorological data are desired in the BOA. The D-5 PEM/DASO/Development program will also require metric data via SATRACK in the BOA,

To document RV integrity, the MX program requires simple streak photography, which may be obtained from a mobile platform.

(U) Several factors affect the selection of BOA locations. First, the BOAs must be located at realistic azimuths and ranges from the launch areas. The ranges between the launch areas and BOAs for the various programs are comparable to those cited previously for the ITAs.

X  
MIRV  
testing  
at  
BOA 1 &  
2  
near  
Wake?

Satellite  
Tracking  
PEM:  
Program  
Evaluation  
Mobile  
DASO:  
Demo +  
shakedown

from Vol II  
39

(U) Second, the BOA must be located such that the test objects have acceptable casualty risks enroute to the terminal area. Finally, the ocean floor must be accessible for implanting deep ocean transponders (DOTs) that are employed for RV impact scoring.

BOA  
sites  
determined...

2. BOA Consolidation (U)

from vol II

**FIGURE 8 (U) PACIFIC CONSOLIDATED BOAs**

3. Mobile Support Criteria (U)

(U) Mobile instrumentation in the form of aircraft and ships have been employed in the past and will continue to provide instrumentation support to the BOAs. The basic instrumentation assets have been Advanced Range Instrumentation Aircraft (ARIA) for telemetry support; P-3 aircraft for scoring support; and Advanced Range Instrumentation Ships (ARIS) for telemetry, optical and radar signature, metric, and meteorological support. These assets are described in detail in Section V.

(U) The newer missile systems are imposing new requirements on these BOA support assets which must be addressed. Many of the advanced missile systems are employing multiple IRVs that require acquisition of telemetry data. This requires multiple ARIA to support the terminal area.

# UNCLASSIFIED

(U) As the missile ranges are increased, the BOAs must be in more remote locations. These remote locations require the aircraft and ships to spend more time transiting to support the test events. These longer transit times particularly constrain the aircraft support platforms, since fuel expended enroute to the BOA reduces the available time on station to support the test events.

(U) Finally, the cost of operating the ships and aircraft continues to increase. In an effort to reduce test costs, the program offices must consider the value of each type of data to be obtained and may neglect important failure analysis data under the assumption that tests will always be successful. The user cost impacts of employing expensive resources, such as the ARIS (USNS Hoyt S. Vandenberg), have also been witnessed during this study. Excessive ship costs substantially reduced the projected utilization of this asset.

# UNCLASSIFIED

## IV EXISTING ITA RESOURCES AND ALTERNATIVES (U)

(U) Section IV describes the capabilities and requirements of the existing ITAs, alternatives considered by the SSTSS Working Group, and the implementation planning of the KMR contingency recommended by the SSTSS Working Group.

### A. Existing ITA Resources (U)

(U) There are currently two ITAs: Ascension Island, serving the Eastern Test Range in the Atlantic Ocean, and KMR, serving the Western Test Range in the Pacific Ocean. Ascension Island resources are managed by the Eastern Space and Missile Center (ESMC), Patrick Air Force Base, Florida, and the KMR is managed by the Kwajalein Missile Range Directorate, BMDSCOM-R, Huntsville, Alabama.

#### 1. Ascension Island (U)

(U) Ascension Island is a British colony in the south Atlantic Ocean, approximately 4500 nmi southeast of Cape Canaveral. The existing U.S.-operated strategic system testing instrumentation assets and their locations on Ascension Island are shown in Figure 9.

(U) The following SSTS functions can be performed by existing or proposed assets at the Ascension Island ITA:

- (U) Metric data are provided by two C-band radars (an AN/FPQ-15 and an AN/TPQ-18) located on either end of the island. No additional metric capabilities are programmed for the future.
- (U) Telemetry data can be acquired with two dual-polarization, 20-channel, S-band telemetry systems (TAA-3 and TAA-3B in Figure 9) located on South Gannet Hill. Two additional units of comparable capability and one Telemetry Doppler Multi-static Measurement System (TDMMS) unit is scheduled for installation on the island.



# UNCLASSIFIED

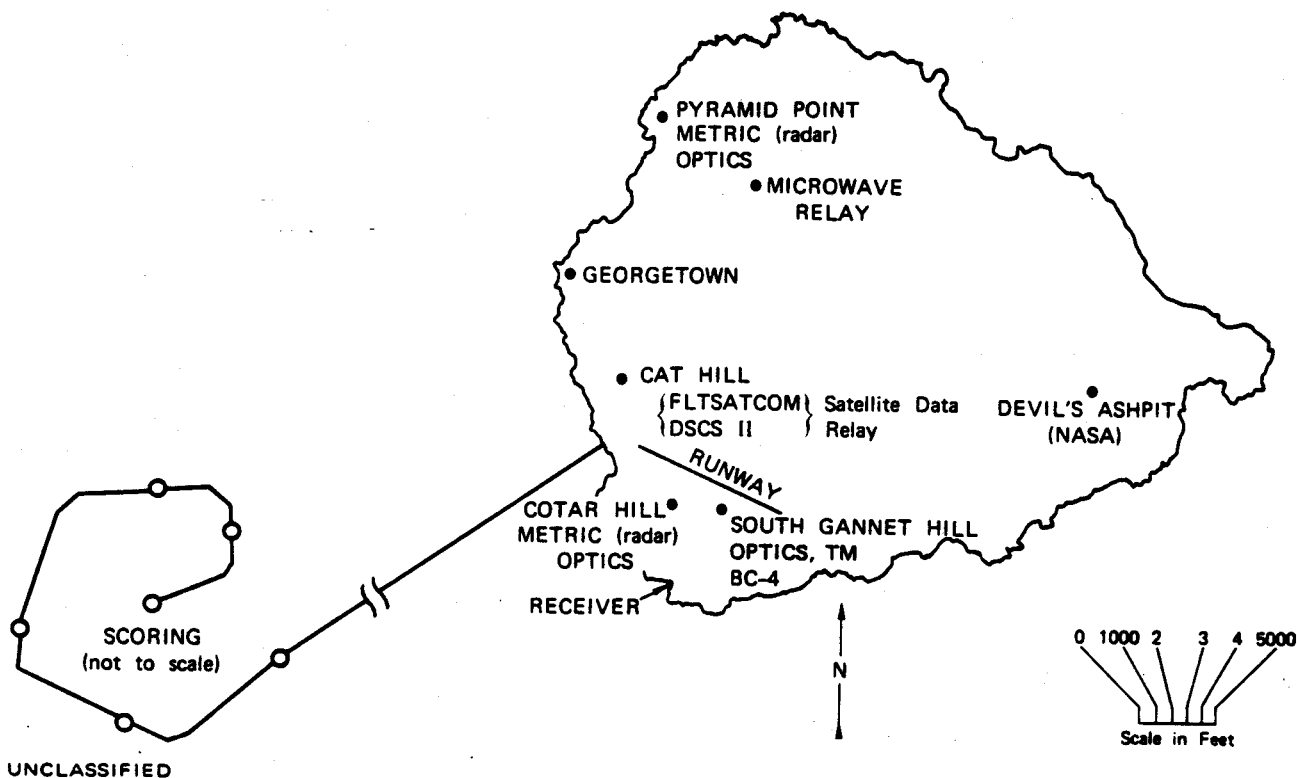

FIGURE 9 (U) ASCENSION ISLAND BASELINE (Atlantic) ITA

- (U) A Missile Impact Location System (MILS) is located west of the island to score RV impacts. Expansion of the MILS or implementing of additional scoring capabilities is not programmed for the future.
- (U) The only radar signature measurement capability at Ascension Island can be obtained with the FPQ-15 and TPQ-18 C-band radars. No expansion or improvements to these capabilities are programmed.
- (U) Optical measurements are provided by three Contraves cine-theodolite cameras and two BC-4 ballistic cameras located as shown in Figure 9. No improvements to the optical systems are scheduled.
- (U) Provisions for underwater recovery are neither available nor planned.
- (U) Meteorological data.
- (U) Data and voice communications are available through satellite and HF, VHF, and UHF radio.
- (U) The ITA has SIGMA 5, XDS-530, NOVA 1200, and LSI-11 computers available to process information and to provide inter- and intrasite acquisition and designation.

(U) The Ascension Island ITA has sufficient instrumentation assets to support the Navy POSEIDON, TRIDENT, and ADVANCED TRIDENT launches scheduled to be targeted there. Ascension Island does not have sufficient geography or instrumentation to support complex instrumentation geometry required by programs such as the Air Force ABRES program or the Army BMD programs. Even if the instrumentation for these programs could be installed at Ascension Island, the Air Force MINUTEMAN programs, which provide many of the TOOs required by the BMD programs, would need to relocate the launch facilities from VAFB to the East Coast to use the Ascension Island terminal area.

2. Kwajalein Missile Range (U)

(U) KMR is a sophisticated and complex terminal test area. It provides range instrumentation for collecting telemetry, radar metric data, meteorology, photography, and optics, and also offers a broad-spectrum, wide-band signature measurements capability, the Kiernan Reentry Measurement Systems (KREMS)

(U) KMR utilizes a number of the islands forming the Kwajalein Atoll in the Marshall Islands, a United States Trust Territory. The ITA is approximately 4200 nmi west of VAFB.

a. Instrumentation Assets (U)

(U) The existing and proposed major instrumentation assets of KMR are shown in Figure 10 (Ascension Island is inset for size reference).

# UNCLASSIFIED

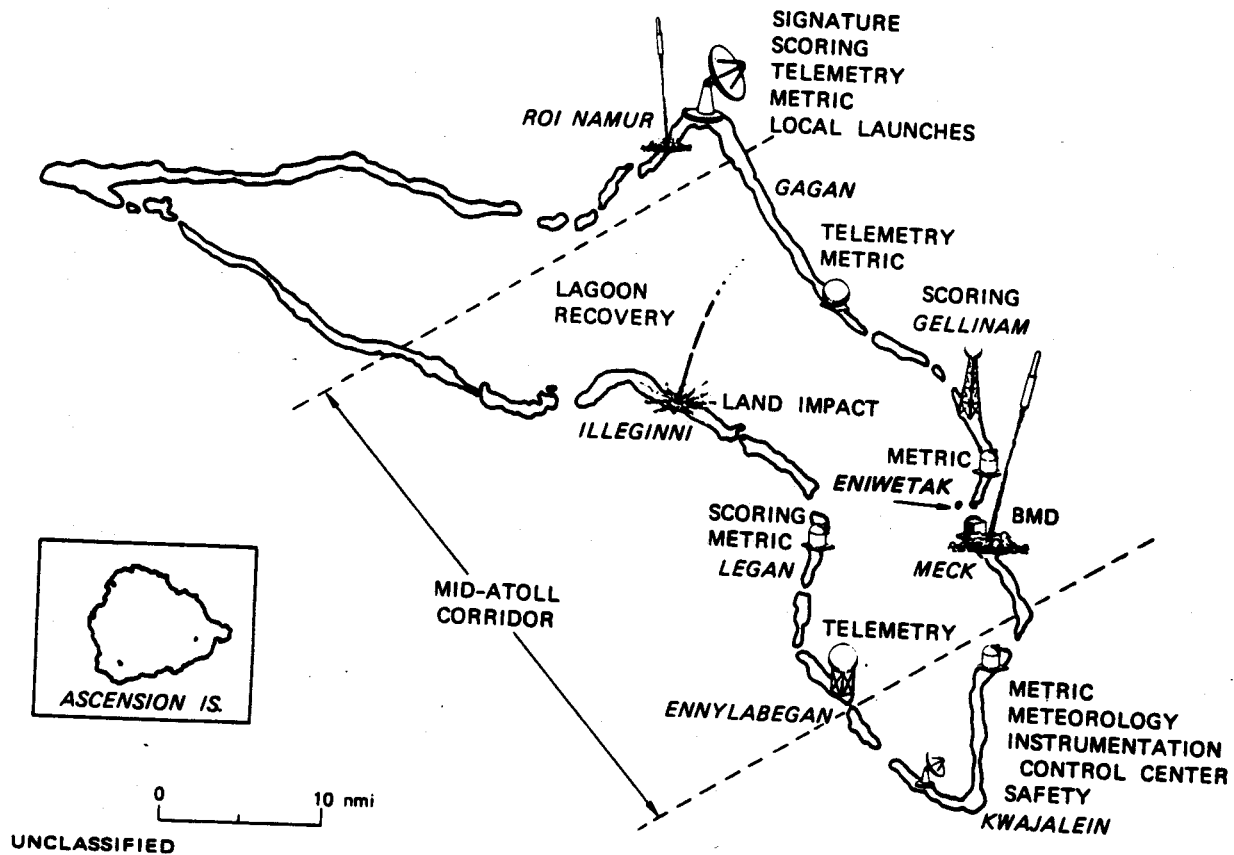

FIGURE 10 (U) KWAJALEIN MISSILE RANGE BASELINE (Pacific) ITA

(U) These assets are:

- (U) Super RADOTS\*-- Eniwetak, Gagan, Kwajalein, Legan, and Roi-Namur--provide long range metric data on RVs using low light level video sensors.
- (U) RADOTS--Eniwetak, Gagan, Legan, and Roi-Namur--provide metric and high-speed sequential photography on RVs
- (U) BC-4 Ballistic Cameras--Eniwetak, Ennylabegan, Gagan, Kwajalein, Legan, and Roi-Namur--are fixed photogrammetric cameras used to provide metric data on RVs.
- (U) Spectral Ballistic Cameras (SBC)--Eniwetak, Ennylabegan, Gagan, and Legan--are colocated with the BC-4 cameras and are employed to provide optical signature data on RVs.

\* (U) RADOTS = Recording and Digital Optical Tracking System

# UNCLASSIFIED

- (U) AN/MPS-36 Radar--Kwajalein--operates at 5400 to 5900 MHz and provides beacon tracking at long ranges and skin track at shorter ranges.
- (U) AN/TPQ-18 Radar--Kwajalein--serves as an acquisition source for metric tracking data in the 5400 to 5900 MHz frequency range.
- (U) Telemetry (TM)--Ennylabegan, Gagan, and Roi-Namur--is provided by S-band telemetry systems that can acquire telemetry data from up to 8 RVs simultaneously, from locally launched systems, or from satellite/space systems.
- (U) Splash Detection Radars (SDR)--Gellinam and Legan--provide impact location of RVs impacting within 20 nmi of the ITA.
- (U) Hydroacoustic Impact Timing System (HITS)--Gellinam--will provide impact time and location of RVs within the lagoon.
- (U) Kwajalein Range Safety System (KRSS)--Kwajalein--employs metric radars on Roi-Namur and Kwajalein and computer facilities on Kwajalein to provide real-time flight safety control.
- (U) ARPA-Lincoln C-band Observables Radar (ALCOR)--Roi-Namur--provides high accuracy tracking, high-resolution C-band signature, and wideband satellite imaging.
- (U) Target Resolution and Discrimination Experiments (TRADEX)--Roi-Namur--provides L-band and S-band RV and wake signature and accurate coherent metric data.
- (U) ARPA Long-Range Tracking and Instrumentation Radar (ALTAIR)--Roi-Namur--provides UHF and VHF signature data and long-range satellite tracking.
- (U) Instrumentation Computer Center (ICC)--Kwajalein--provides real-time acquisition and processing of missile position and velocity for KMR-launched missiles and for RVs. The computational facilities consist of CDC 7600 computer, CDC 6400 computer, SEL 810A computers, SEL 810B computers, MOD COMP IV computer, Interdata 832 computers, BAC-11/780 computer, Harris 6024/1 computer, and Data General ECLIPSE computer.

In addition to the above major instrumentation assets, KMR provides extensive balloon meteorological rocket-borne measurement capabilities, RV and interceptor recovery, launch and ordnance support facilities, intra- and inter-atoll and interranger communications, frequency and time control and analysis, calibration facilities, and a range operations control center.

# UNCLASSIFIED

(U) Sufficient instrumentation is currently available at KMR to support most of the strategic system testing scheduled to be targeted for the KMR Mid-Atoll Corridor and to support the Army BMD programs scheduled for development at KMR. MX flights would require WSMC to provide multistation tracking instrumentation, including sufficient IIP capability to support range safety requirements if this missile were required to impact in the KMR lagoon. Since MX has no requirement to impact in the lagoon, it will be targeted to an area approximately 80 nmi north of the lagoon (KMRN). The instrumentation requirements to support KMRN are addressed in Section V of this report.

## b. Political Situation at KMR (U)

(U) The Army currently uses eleven of the more than 100 islands within the Kwajalein Atoll to support DoD developmental and operational testing of strategic offensive and defensive weapon systems. Seven of these islands, including Kwajalein, were leased by the Trust Territory of the Pacific Islands (TTPI), utilizing DoD funding. These long-term (25 to 99 year) leases were then assigned to the United States Government by the TTPI.

X (U) Three of the eleven islands (Eniwetak, Omelek, and Gellinam) were obtained by the TTPI by condemnation action, and use and occupancy rights were assigned to the U.S. government pending either a negotiated settlement or one adjudicated by the TTPI courts. In July 1979, the TTPI court issued a judgment in the case of these three islands in the amount of \$192,055 for a lease covering the period of 1966 to 1981. This judgment has been appealed by the landowners.

X (U) In 1965, the TTPI granted indefinite-term use and occupancy rights to the U.S. government for Roi-Namur Island. Negotiations were held periodically (after the TTPI ruled that Roi-Namur was private, rather than public, land), without agreement, until 1975, when the landowners filed a \$100 million suit against the U.S. government in the U.S. Court of Claims, alleging the Marshallese landowners were injured by the taking of the island and by its continued use by the U.S. government.

# UNCLASSIFIED

Table 6

(U) SUMMARY OF POLITICAL EVENTS AT KMR  
(June to September 1979)

Date	Event
20 June	Ataji Balos (GOM cabinet) demands high-level discussions.
12 July	20 Marshallese occupy Eniwetak and Omelek.
20 July	100 Marshallese occupy Roi Namur and Kwajalein Island.
27 July	Maj. Gen. Grayson Tate (Cmdr BMDSCOM/KMRD) briefs GOM President Amata Kabua on safety of use of depleted uranium on reentry vehicles.
29 July	Ataji Balos (after meeting with U.S. Ambassador Rosenblatt) directs group of 500 Marshallese on Kwajalein to disperse throughout island.
29 July	Maj. Gen. Tate advises President Kabua of action by Ataji Balos.
30 July	President Kabua advises Ambassador Rosenblatt that GOM had no jurisdiction over illegal occupants, but would commence negotiations with United States for interim arrangement.
31 July	Ambassador Rosenblatt advises President Kabua of his recommendation for United States to reconsider negotiations if Marshallese evacuate KMR.
6 August	Marshallese evacuate Kwajalein and Bigej Islands; DoD and GOM agree to negotiate interim agreement.
29 August	All islands evacuated by Marshallese.
20 September	Navy facilities Engr. Command issues \$142,863 check to High Commissioner, TTPI, for use of Eniwetak, Omelek, and Gellinan.
26 September	Honolulu meeting: GOM and landowners meet with DoD to negotiate lease amounts. No agreements; meeting scheduled in Washington, D.C., on 18 November.

UNCLASSIFIED

# UNCLASSIFIED

1. Recommended Mobile Instrumentation Support at KMRN (U)

(U) The instrumentation required for MX test support at KMRN are:

- (U) Streak-optics.
- (U) Impact scoring on all RVs.

(U) Several reasons prompted investigation of mobile instrumentation support at KMRN:

- (U) The cost of ship-installed and -maintained DOTs for RV scoring is very high.
- (U) Opportunities were being investigated by KMRD for reducing the aircraft workload by supplemental land-based instrumentation concepts on the small islands around the Kwajaleih Atoll.
- (U) The advantages of supporting a nearby BOA from KMR rather than CONUS seem economically and operationally attractive.

(U) The recommended alternative for MX support at KMRN consists of two primary elements:

- (U) A C-7A Terminal Area Support Aircraft (TASA) equipped with:
  - (U) Supplemental (terminal) telemetry system
  - (U) SMILS scoring capability
  - (U) Streak-optics camera system.
- (U) A K-BOAT for:
  - (U) Initial DOT installation
  - (U) Continued DOT maintenance.

B. SSTSS Alternatives to KMR (U)

(U) Primarily because of the cost impact and political attitudes which surfaced in the recent negotiations with the Marshallese for continued use of KMR, alternative ITAs to support strategic system testing were investigated by the SSTSS Working Group as a contingency. This section discusses the selection criteria employed, the alternatives considered, and the implementation of the recommended alternative.



# UNCLASSIFIED

## 1. ITA Selection Criteria (U)

(U) The major criteria considered in determining the potential use of areas as an ITA are summarized in Table 7. Driving ITA criteria are:

- (U) Distance from existing or potential launch areas.
- (U) Populated land masses in the trajectory between the launch area and the ITA.
- (U) Amount of land and/or number of islands available to support instrumentation and facilities and to establish baselegs for instrumentation.
- (U) Availability of shallow water recovery areas.
- (U) Availability of land use to the United States.

An

island area is preferred, since it will minimize the problem of evacuation of personnel not essential to the test missions. A further constraint on the ITA location is that populated land masses between the potential ITA and launch areas cannot be over-flown in event the weapon system flight must be prematurely terminated.

(U) The island area to be employed as an ITA must have sufficient land area available to support the instrumentation assets required to perform the basic functions outlined in Section III. In addition to the basic technical support requirements, space must be available for an air strip, helicopter pad, and boat dock, so that operational personnel may be transported to and from the facility. To minimize personnel transportation costs, provisions should be made nearby for housing and other personnel support facilities.

(U) MINUTEMAN II and the BMD programs impose additional requirements on the ITA. The MINUTEMAN II must impact a shallow water area so that the instrumentation package and recorded data may be recovered. Many of the BMD interceptors also require shallow water recovery. Additionally, the BMD programs require large separations (in the order of 20 nmi) between optical and radar signature measurement instrumentation to obtain RV signature data from varied and low aspect angles. This separation

(U)

geometry is usually only found in an island group. Low aspect angles between an instrumentation site and an incoming object's trajectory translates directly into a safety problem in that all personnel, except for a few key operators, must be <sup>evacuated</sup> evaluated from the potential hazard pattern for personnel, property and equipment. ?

(U) The SSTSS Working Group performed only a cursory investigation of the potential availability of any of the proposed ITAs, since final resolution and negotiations are the responsibility of the Department of State.

2. Initial Alternatives (U)

p ~~33~~? 57

# UNCLASSIFIED

## V EXISTING MOBILE INSTRUMENTATION RESOURCES AND ALTERNATIVES (U)

### A. General (U)

(U) Three types of mobile instrumentation assets are currently used for Strategic Systems Test Support: (1) the Advanced Range Instrumentation Aircraft (ARIA), (2) the P-3C aircraft equipped for RV impact scoring, and (3) Advanced Range Instrumentation Ships (ARIS). These mobile assets permit test operations, such as ballistic missile terminal area impacts, to be supported in the BOAs over most of the world.

(U) Figure 17 depicts the generic BOA support functions that these mobile resources provide. The ARIA, equipped with a large, nose-mounted dish antenna, can provide telemetry collection/recording and data relay for testing operations remote from land-based instrumentation resources.

(U) A common accompaniment to the ARIA during ICBM/FBM support is the P-3C aircraft, which is equipped to perform RV impact scoring using the Sonobuoy Missile Impact Location System (SMILS). This system, which permits scoring RV impacts to about 50-ft geodetic accuracy, is based on the use of specially modified sonobuoys to relay the acoustic splash to the stationkeeping P-3C. A receiving system on the P-3C aircraft records the acoustic data for subsequent scoring analysis. Two P-3C aircraft are thus equipped and provide FBM terminal area support in the Atlantic from the U.S. Navy VX-1 Squadron at Patuxent River.

(U) The geodetic reference for the sonobuoy scoring pattern is provided acoustically by an array of DOTs which are installed and surveyed by a ship. \*

(U) The ARIS currently available for terminal area support are the USNS Vandenberg and the USNS Arnold. These assets are heavily instrumented with telemetry, optics, meteorology, and radars that provide limited signature and metric tracking capability. Another function the ARIS performs is the installation and periodic maintenance of the scoring DOT arrays.

~~Vol III~~

79

from Vol II

(54-73 deleted)

# UNCLASSIFIED

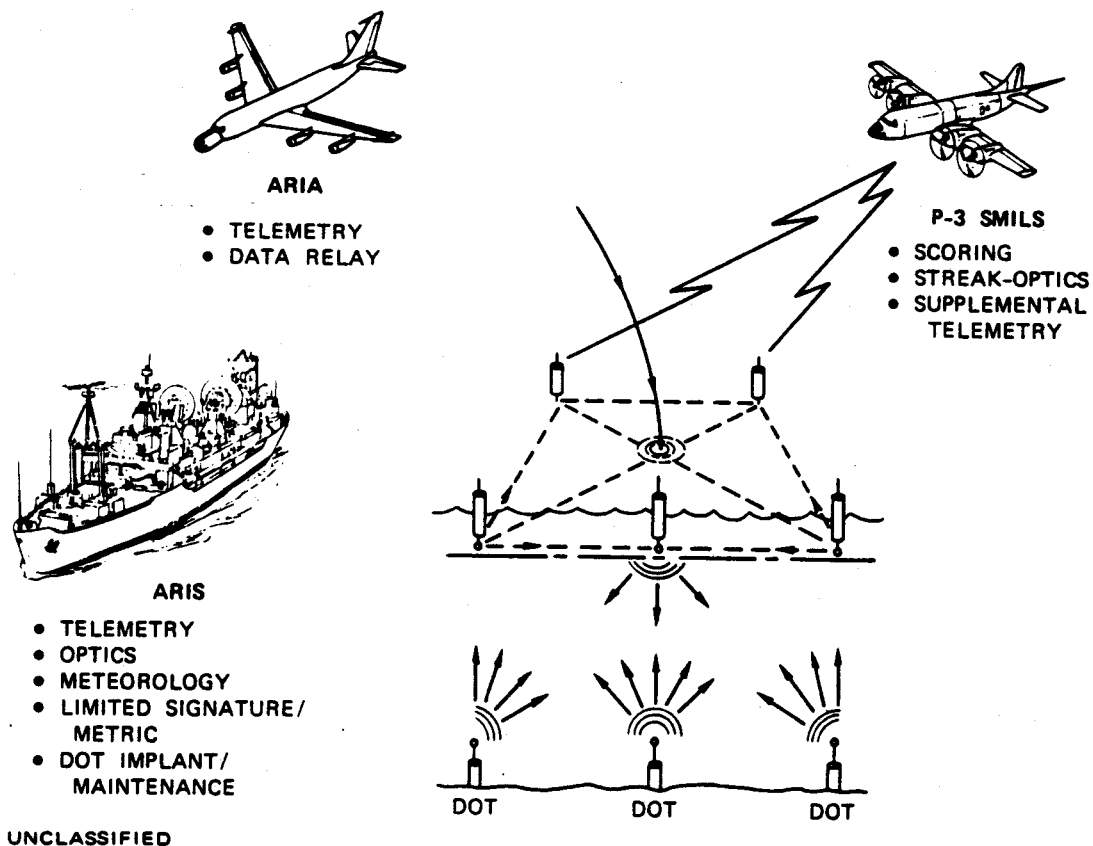

FIGURE 17 (U) BASELINE MOBILE RESOURCES USED FOR TERMINAL AREA SUPPORT

(U) One other instrumentation ship is the USNS Wheeling. This resource was in a "down-hard," inactive status at the outset of the SSTSS and was budgeted for replacement by a C-4-type hull.

(U) Section V will examine these resources, their capabilities, limitations, and future workload projections. Various alternatives will then be considered for optimizing these mobile assets into more operationally and economically efficient configurations.

B. Baseline Advanced Range Instrumentation Aircraft (ARIA) (U)

(U) The ARIA are a fleet of eight C-135-type aircraft, instrumented as shown in Figure 18 to receive and record telemetry signals; process, record, and relay telemetry data; and provide communications relay. The

*from vol II*

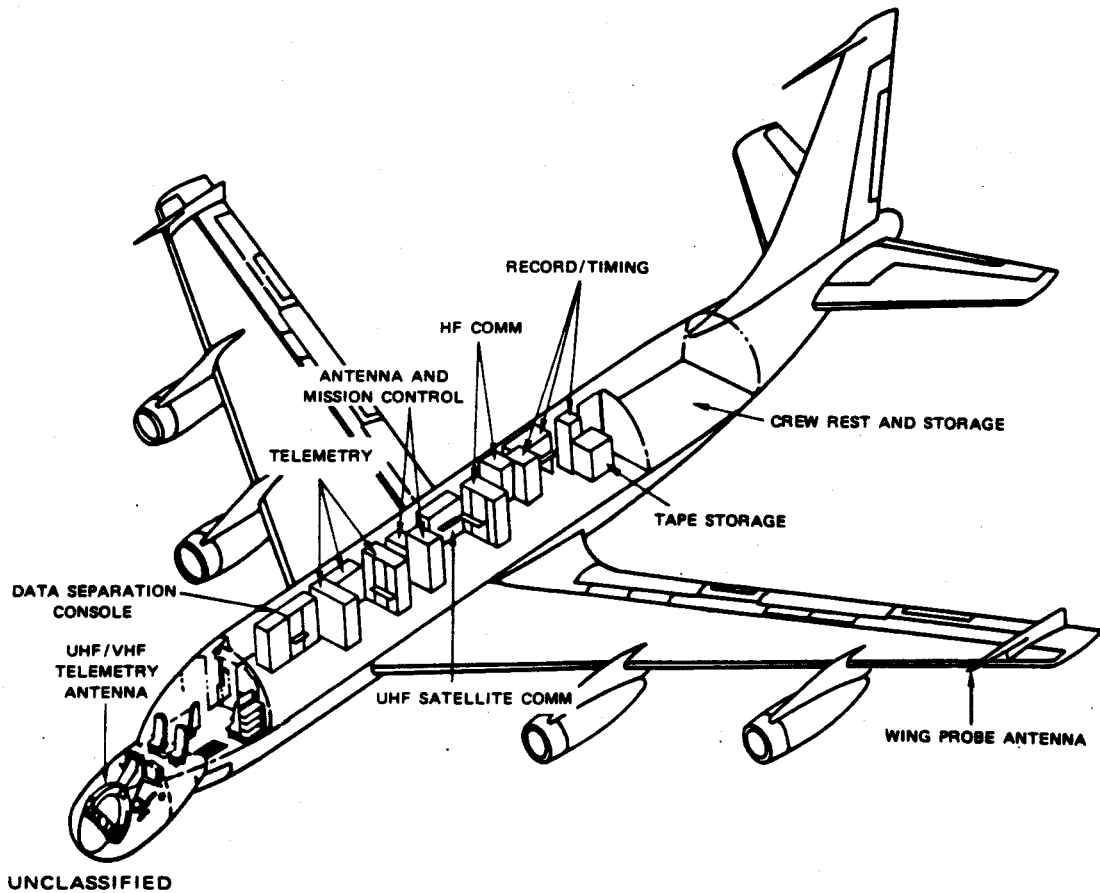

FIGURE 18 (U) ARIA INTERIOR MODIFICATIONS

(U)

fleet consists of five A models (EC-135N)\* and two B models, which are based at Wright-Patterson Air Force Base (WPAFB) and managed and operated by the 4950th Test Wing.

1. ARIA Capabilities (U)

(U) The ARIA are configured to operate, and provide instrumentation support to, space and missile programs worldwide. The primary difference

---

\* (U) On 6 May 1981, during the preparation of this report, an ARIA EC-135N crashed during a training exercise, reducing the ARIA fleet size to seven aircraft. This occurrence did not affect the study recommendations.

*from vol II*

# UNCLASSIFIED

(U)

between the A and B models is the engine; the older EC-135N(A) airframe is powered by J-57 turbojet engines, while the newer EC-135N(B) airframe is equipped with T-33 turbo fan engines. The T-33 engine, and its associated airframe modifications, permit longer ranges and/or more time on station than the J-57 engines and alleviate several other problems inherent to the J-57 engine as discussed in Section V-A-2.

(U) Modifications necessary to convert the basic C-135 aircraft into an ARIA include the installation of a 7-ft diameter steerable dish antenna plus telemetry reception, recording, and communication systems than can be configured to support a multiplicity of DoD and NASA missions. Among the telemetry functions are:

- (U) Tracking of telemetry from space and reentry vehicles
- (U) Telemetry reception and recording
- (U) Onboard data processing (including signal reformatting)
- (U) Data relay (real-time and postmission)
- (U) Space vehicle voice communications relay.

(U) The basic mission of the ARIA system is to receive, process, and record S-band (2.2 to 2.3 GHz) telemetry signals from spacecraft and missile RVs. Because of this emphasis, the ARIA 7-ft tracking antenna feed system has been recently modified to optimize S-band signal reception capability. Prior antenna feed structures also included L-band and UHF capability.

(U) To further the basic mission role (S-band telemetry), which may include the requirement for real-time or postmission data retransmission, an HF communications system is onboard the ARIA. Wing probe antennas and a long, trailing-wire antenna are available for the HF communication and data relay subsystems. Additional data relay capability is provided via a UHF satellite system included in the ARIA communications suite. A steerable UHF satellite antenna is mounted on top of the ARIA to access military communications satellites.

*from vol II*

# UNCLASSIFIED

(U) To perform the basic ARIA mission, a minimum aircraft crew of 12 is needed. These include:

- (U) 2 pilots
- (U) 1 navigator
- (U) 1 flight mechanic
- (U) 1 mission coordinator
- (U) 7 electronic technicians.

(U) For extended overseas missions, this basic crew is augmented to 18 by the addition of the following 6 crew members:

- (U) 1 pilot
- (U) 1 navigator
- (U) 1 airframe mechanic
- (U) 1 engine mechanic
- (U) 1 hydraulic mechanic
- (U) 1 systems analyst.

Occasionally, an electronics engineer is added to bring the total overseas crew to 19.

(U) Several key subsystems makeup the prime mission electronic equipment (PMEE) aboard the ARIA. These are:

- (U) Voice and Telemetry Subsystem
- (U) Timing Subsystem
- (U) Communications Subsystem
- (U) Data Processing Subsystem
- (U) Mission control console.

(U) The Voice and Telemetry Subsystem includes the antenna group that acquires and tracks telemetry signals from spacecraft or instrumentation reentry vehicles (IRVs). The antenna can be positioned by a computer using the trajectory of the telemetry vehicles, which is stored on a disc file. Signals received by the antenna group are fed to the radio frequency (RF) group (consisting of the data and tracking receivers) to process the signals. Included in the RF group is equipment to perform system calibration, group interface, and data transfer operations. This

# UNCLASSIFIED

(U)

group has considerable adaptability to accommodate different frequencies and signal formats. Outputs from the RF group go to the record group, where signals may be recorded according to user requirements and monitored in real-time, and previously recorded data may be played back. Recording bandwidths are available from 400 Hz to 2 MHz in the direct-record mode on 14-track tape; dc to 400 Hz bandwidth is available in the two identical FM mode recorders installed in the record group.

(U) Timing is provided by the ARIA with an internal timing subsystem. All timing codes provided from this subsystem use a rubidium frequency standard. Synchronization with WWV-Boulder or WWVH-Hawaii results in a very fine time accuracy worldwide. Battery pack back-up power sources are available. The various equipment and aircraft crew stations are provided displays of universal coordinated time and mission countdown or mission elapsed time from the timing subsystem.

(U) Communications to and from the ARIA are via three high frequency (HF) single sideband transmitter and receiver systems and a 1000-W ultra-high frequency (UHF) satellite terminal. The HF systems operate over 2-30 MHz with a transmitter output power of 1000 W each. Data relay may be accomplished via HF (at rates up to 3000 bits) and the satellite system. The UHF system can send data at rates up to 60,000 bps, but is limited to those areas of the world (and times of visibility) visible to a U.S. military communications satellite. X

(U) For overall mission control, the ARIA has a mission control console through which the mission controller coordinates the various functions of the PMEE operations and the aircraft position, altitude, etc. The mission controller is the interface between the aircraft crew and the PMEE crew.

(U) The data processing subsystem is available to breakout individual components of the signals (either analog or digital) for onboard data analysis or signal reformatting (for retransmission) of telemetry data. These components may be displayed for examination onboard the



# UNCLASSIFIED

(U)

ARIA and/or retransmitted to the user. A minicomputer (part of the data processing subsystem) reformats digital telemetry signals into formats and bit rates suitable for retransmission by either the HF or UHF satellite communications systems.

(U) Three of the ARIA fleet have been especially modified to support ALCM tests. These modifications mainly provide additional L-band communications capability required for ALCM control and flight termination. For this purpose, full-time contact with the test missile is required, since loss of communications with the ARIA (or F-4 chase plane) will cause automatic flight termination of the ALCM after a short period. An additional computer/navigational system interface provides telemetry antenna positioning to track the ALCM accurately and also provides a display readout of ARIA ground speed and distance between the ALCM and ARIA.

(U) Each ARIA can receive telemetry data from a single source. (A four-beam, phased-array antenna [APATS] has been proposed so that a single ARIA can receive telemetry data from four objects simultaneously; this will be discussed below.) For SSTS, the present configuration generally requires one ARIA to receive telemetry data from each IRV entering a terminal area. When there is sufficient time separation between IRVs, it is possible for a single ARIA to collect telemetry data from the first IRV until impact, then begin receiving the telemetry data from a second IRV.

## 2. ARIA Deficiencies and Improvements (U)

(U) Data obtained from 4950th Test Wing (TW) concerning present ARIA staging areas for the test support of various ICBM programs indicate the amount of ARIA time-on-station (TOS) is less than the 4 h desired by the range groups for some of the impact areas. Figure 19 shows the Atlantic and Pacific Ocean impact locations with the ARIA staging areas and the TOS for the EC-135N (A model aircraft), the higher performance C-135B, and a potential upgraded ARIA. Note that, for the

# UNCLASSIFIED

# UNCLASSIFIED

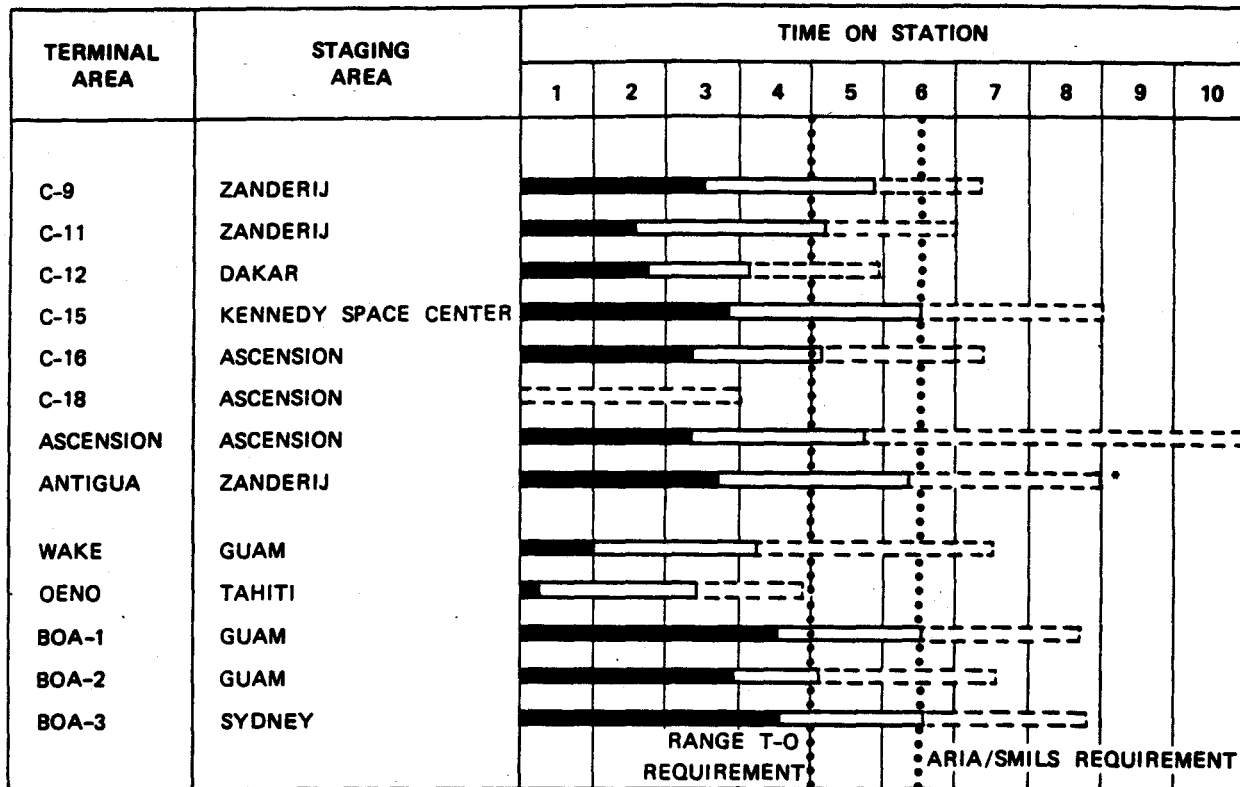

\*REENGINED ARIA WOULD BE STAGED FROM KENNEDY SPACE CENTER TO SUPPORT ANTIGUA

**LEGEND**

- ARIA "A"
  - ARIA "B"
  - UPGRADED ARIA
- UNCLASSIFIED

FIGURE 19 (U) TIME-ON-STATION COMPARISON OF EXISTING AND UPGRADED ARIAs

*To. time one?*

# UNCLASSIFIED

(U)

basic mission, the A model does not meet the range desire of 4 h on station for any impact location. The B model meets many of the TOS requirements, but not all. Thus, to meet the 4-h on-station requirement, some form of improved aircraft performance is mandatory, or two aircraft must be launched from the staging area with staggered launch times. X

Ex 5

(U) The water-injected J-57 engines produce considerable noise during take-off, and public pressure is being applied through organizations such as the International Civil Aircraft Organization (ICAO) to restrict aircraft equipped with such engines from many of the civilian airports required for routing and staging to support test missions. Furthermore, the availability of distilled water for these engines is becoming more limited at airports. In addition to the operational restrictions, the J-57 engine maintenance and operating costs are escalating, and the TOS limitations will not permit the longer range test missions projected for the future to be supported. X

(U) For these reasons, Congress approved funds for the 4950th TW to acquire six used 707-320Cs, made available by American Airlines in early 1981, to replace the EC-135N ARIA. The acquisition of these aircraft was in consonance with the Universal Range Instrumentation Aircraft (URIA) study which was conducted concurrently with this study.

---

\* (U) Splash Activated Deep Ocean Transponder System.

from vol II 87

# UNCLASSIFIED

# UNCLASSIFIED

## 3. ARIA Baseline Workload (U)

(U) The derivations of the annual ARIA support missions, crew days, aircraft days, and aircraft flight hours required to support the missions previously identified in Section II-B are described below. For this analysis, it was assumed the ARIA fleet would be upgraded with 707-320C airframes and that the required crew days, aircraft days, and flight hours for each support area would be comparable to estimates provided by the 4950th TW for the current B model ARIA.

(U) The number of ARIA missions required to support the terminal area events identified in Table 4 are shown in Table 12. This table was derived employing the following assumptions:

- (U) No ARIA are required to support KMR or KMRN.
- (U) One ARIA is required for telemetry support of each IRV associated with ICBM launches.
  
- (U) One ARIA is required for each test support position identified for PERSHING, space programs, and cruise missile launches.

(U) The flight hours, aircraft days, and crew days to support the terminal areas were derived from time factors estimated by the 4950th TW as shown in Table 13. In addition to the actual crew days, an average of three additional days are required to prepare and calibrate the ARIA PME before departure from WPAFB. In addition to the actual flying time required for the routing shown, one day of premission calibration and one contingency day in the staging area are included in the estimation of crew days and aircraft days. The estimated annual flight hours, aircraft days, and crew days to provide the projected support are presented in Tables 14, 15, and 16, respectively. In addition to the times shown in these tables, the 4950th TW has indicated that past experience has shown that actual flight times are generally about 20% higher than projections because of aborted missions and other unscheduled events.

Table 13

(U) ARIA FLIGHT SCENARIOS

Support Area	Staging Area	Route	Flight Hours	A/C Days	Crew Days
BOA-1	Guam	WPAFB, March AFB, Hickam AFB, Guam, BOA-1	44	9	6
BOA-2	Guam	WPAFB, March AFB, Hickam AFB, Guam, BOA-1	44	9	6
BOA-3	Sydney	WPAFB, March AFB, Hickam AFB, Guam, Sydney, BOA-3	50	9	6
Wake	Guam	WPAFB, March AFB, Hickam AFB, Guam, Wake	44	9	6
Oeno	Tahiti	WPAFB, March AFB, Hickam AFB, Tahiti, Oeno	40	8	5
C9	Zanderij	WPAFB, Zanderij, C9	21	7	4
C11	Zanderij	WPAFB, Zanderij, C11	21	7	4
C12	Dakar	WPAFB, Zanderij, Dakar, C12	28	7	4
C15	Kennedy S.C.	WPAFB, Kennedy Space Center, C15	14	6	3
C16	Ascension	WPAFB, Zanderij, Dakar, Ascension, C16	31	7	4
C18	Ascension	WPAFB, Zanderij, Dakar, Ascension, C18 (Not Supported)	37	7	4
Antigua	Zanderij	WPAFB, Zanderij, Antigua	21	6	3
Ascension	Ascension	WPAFB, Zanderij, Dakar, Ascension	31	7	4

UNCLASSIFIED

90

from vol II

UNCLASSIFIED

UNCLASSIFIED

707.

50 hours flying.

4-6 hours Turn station ARIA.

HAW -> Guam  
Guam -> Sydney.

# UNCLASSIFIED

(U)

These aircraft workload data assumed that an upgraded ARIA would be used, e.g., either a reengined or a 707-320C replacement.

#### 4. Baseline Costs of ARIA (U)

(U) As discussed earlier, the 4950th TW ARIA fleet must be upgraded if it is to support its projected workload. Two ways of providing this upgraded capability were considered: reengining the existing ARIA airframe with a CFM-56 engine or transferring the ARIA mission equipment to a 707-320C airframe. The costs associated with this choice and with future use of the ARIA fleet assets are provided in Table 17.\*

(U) The workload projected for the baseline ARIA fleet between 1982 and 1999, inclusive, is 26,501 flying hours and 5,911 per-diem days. Using the data from Table 17 and the projected ARIA fleet utilization, the total LCCs associated with the two ARIA upgrade fleet alternatives are as shown in Table 18. The data show that transferring ARIA equipment from EC-135N(A) to purchased 707-320C aircraft is significantly less expensive than reengining the EC-135N(A), both in terms of the initial investment required and over the indicated life of the fleet. Thus, the 707 ARIA is used as a basis for baseline ARIA costs in this report.

#### C. P-3 SMILS Aircraft (U)

(U) Presently, P-3 SMILS support is provided by VX-1 from Patuxent River NAS, Maryland. VX-1 has five P-3C aircraft available; one of these aircraft is equipped with the SMILS equipment, one serves as a back-up for SMILS and other mission support, and the remainder are dedicated to other functions (primarily electronic intelligence [ELINT] gathering). To avoid delaying or aborting SMILS missions, the ELINT aircraft have also been temporarily cannibalized to provide spare parts for the SMILS aircraft. VX-1 has agreed to provide SMILS support through FY83 but,

---

\* (U) Data are summarized from the URJA Study Final Report,<sup>3</sup> where more detailed and supporting rationale are provided.

# UNCLASSIFIED

(U)

although they believe they are the most qualified activity to provide such support and are willing to continue, they do not have a commitment beyond that time.

## 1. P-3C SMILS Aircraft Capabilities (U)

(U) At present, all aircraft support for RV impact scoring in the BOA using SMILS as the scoring technique is accomplished using one of the two modified P-3C aircraft operated by VX-1. These two aircraft have been modified to accommodate an instrumentation pallet incorporating tape recorders, time code generators, visicorder, a small computer, and sonobuoy receivers. In addition to this equipment, the aircraft must be equipped with a tactical control (TACCO) display for the proper positioning of the sonobuoys, dual inertial navigation systems, Omega navigation, and storage and launching facilities for sonobuoys. The VX-1 P-3C aircraft have the appropriate navigation systems, sonobuoy storage and launching capability, TACCOs, and sonobuoy receivers as part of the basic antisubmarine warfare (ASW) electronics suite. The instrumentation pallet incorporates the additional equipment required for the SMILS.

(U) Other tasks have been assigned to the basic SMILS aircraft to be accomplished in conjunction with the SMILS scoring activity. These tasks include obtaining streak photography of the incoming RVs and collecting telemetry from IRVs to supplement those obtained by an ARIA. Because of its low altitude, the SMILS aircraft can provide telemetry during the impact period and perhaps improve on postimpact telemetry.

(U) The requirement for the SMILS aircraft to have dual inertial navigation systems and an associated Omega navigator is set by the precision and accuracy required for sonobuoy deployment. These units must be dropped over the fixed bottom-mounted DOTs already in place in three concentric circles of 2, 4, and 7 nmi. Precise navigation is necessary to place the aircraft correctly over the DOT array, where it can use an air-deployed interrogator buoy and onboard computation to

# UNCLASSIFIED

(U)

update its position by interrogating the ship-surveyed DOT array. These updated position data and the P-3C TACCO display then allow the sonobuoys to be deployed with the necessary precision over the DOT array.

(U) Streak photography is accomplished by a cabin-mounted (forward of the aircraft wing) stabilized optical system and an optical window. The optical installation in the VX-1 P-3C is self-contained and is operated by contract personnel.

(U) Supplementary telemetry is obtained by the installation of a low-gain horn antenna (S-band), telemetry receiver, and wideband tape recorder. The supplementary telemetry system is also operated by contractor personnel.

(U) Crew size for a maximum leg mission is 15, consisting of:

- (U) 3 pilots
- (U) 2 flight engineers
- (U) 1 navigator
- (U) 1 radio man
- (U) 1 radar man
- (U) 1 tactical coordinator
- (U) 1 ordance man
- (U) 1 in-flight technician
- (U) 1 contractor, telemetry
- (U) 1 contractor, optics
- (U) 2 contractors, SMILS.

15 crew.

Under certain conditions, some of the crew tasks could be combined and the extra pilot eliminated. Operation out of staging bases equipped to maintain P-3 aircraft could possibly allow reducing crew size by one. Contractor support is currently provided to VX-1 by the Palisades Geophysical Institute (PGI); personnel are picked up in Bermuda\* before each mission.

---

\* (U) PGI is planning to relocate in Florida.



# UNCLASSIFIED

## 2. Workload Analysis for P-3C SMILS (U)

(U) The annual missions to be supported by the P-3C SMILS are shown in Table 19. Each test mission indicated requires one P-3C SMILS aircraft. Note that the P-3C SMILS are only required to support the ICBM missions; cruise missile and space mission support are not anticipated for the P-3 aircraft.

(U) The estimated flight hours, aircraft days, and crew days to support the terminal areas were derived from flight scenario discussions with VX-1, as shown in Table 20. For these estimates, it was assumed that all Atlantic Ocean support would be provided with aircraft based at Patuxent River NAS. Two P-3A aircraft have been identified to support the Pacific Ocean terminal areas on an interim basis, and it was assumed the Pacific Ocean terminal areas will be supported by aircraft based at PMTC. The estimated flight hours, aircraft days, and crew days to provide the projected P-3 SMILS terminal area support are shown in Tables 21 and 22, respectively. The aircraft days were estimated assuming one contingency day and one day of crew rest during each mission.



(U) MX flight tests (DT&E and IOT&E) will require multiple-object telemetry and scoring in the ITA as well as simple streak photography and meteorological data. Metric data are not required, but will be acquired if the capability is readily available in the ITA. Radar signature data will be required in the ITA only if new penetration aids (PENAIIDs) are developed; however, this is not planned. Similarly, land impact will be required only if new fusing is developed. In the BOA, only telemetry, scoring, and simple streak photography of multiple reentry vehicles (RVs) are required. Meteorological data may be desired in the BOA for accuracy assessment tests.

p99 ?

implied in text.  
to / from

Table 20

(U) P-3C SMILS FLIGHT SCENARIOS

Support Area	Staging Area	Route	Flight Hours	A/C Days	Crew Days
KMRN	KMR	PMTC, Barber Point, KMR	32	6	6
BOA-1	Guam	PMTC, Barber Point, Midway, Guam, BOA-1	41	7	7
BOA-2	Guam	PMTC, Barber Point, Midway, Guam, BOA-2	45	7	7
BOA-3	Sydney	PMTC, Barber Point, Wake, Sydney, BOA-3	50	9	9
Wake	Wake	PMTC, Barber Point, Wake	31	5	5
Oeno	Tahiti	PMTC, Barber Point, Tahiti, Oeno	41	7	7
C9	Antigua	Pax River NAS, Bermuda, Antigua, C9	16	3	3
C11	Fortaleza	Pax River NAS, Bermuda, Fortaleza, C11	31	7	7
C12	Fortaleza	Pax River NAS, Bermuda, Fortaleza, C12	31	7	7
C15	Bermuda	Pax River NAS, Bermuda, C15	14	3	3
C16	Ascension	Pax River NAS, Bermuda, Antigua, Ascension, C-16	43	7	7
C18		(P-3C cannot support)			
Antigua		(no P-3C support requested)			
Ascension	Ascension	Pax River NAS, Bermuda, Antigua, Ascension	37	7	7

UNCLASSIFIED

100

from ref #

UNCLASSIFIED

UNCLASSIFIED

12,777 km SF - HAW - Wake - Sydney

P3 velocity:

Econ: speed (cruise) 25,000 ft: 608 km/h } = 2.02 h one way x 2 = 4.04 h.  
 Patrol speed at 1500 feet = 381 km/h }  
 (max speed at 15,000 ft) = 761 km/h

Haw - Hon = 2774 mi  
 Gr Circle: Sydney - Hon = 5090 mi  
 ||

leaves 8 hours to refuel: Hon. Wake, Sydney = 6 times.  
 at 45 min = 4.5 h.  
 leaves 4 hours to/from site. = 12.16 km (+ Δ hours over site).

# UNCLASSIFIED

(U)

of two aircraft being available for mission support, three aircraft must be available.<sup>3</sup> One additional aircraft should be available to accommodate PME and airframe maintenance, although the modest workload may permit scheduling maintenance around support events.

#### 4. Baseline Costs for P-3C SMILS (U)

(U) Baseline costs associated with P-3 aircraft are provided in Table 23. P-3C aircraft out of VX-1 squadron are currently used to support SMILS scoring in the Atlantic; P-3A aircraft are being configured to support SMILS operations and are to be used as a platform for the PMTC EATS Airborne Instrumentation System (AIS). These P-3A aircraft may ultimately have to be modified to provide P-3B/C performance, if used in a global, ballistic missile test support role.

#### D. Alternative Mobile Instrumentation Aircraft Considerations (U)

##### 1. Discussion (U)

(U) The previous section on baseline aircraft indicated that the national mobile instrumentation aircraft resources that have historically supported strategic weapons testing and NASA/DoD satellite programs will continue to be needed through the turn of the century, principally for the Navy's TRIDENT and the Air Force's MX and cruise missile test programs. Currently, these resources consist of eight\* ARIA at the 4950th TW, WPAFB, and two Navy P-3C ASW-type aircraft operated out of the VX-1 squadron on the East Coast.

(U) The ARIA provide telemetry collection, recording, and communications for programs requiring instrumentation support in remote areas of the world, such as the BOAs where land-based resources are unavailable. The P-3C aircraft from the Navy's VX-1 squadron provide the RV impact scoring function in the Atlantic BOAs by dispensing specially modified sonobuoys into a SMILS pattern deployed over a pre-installed and -surveyed DOT array.

---

\* (U) One EC-135N was lost on 6 May 1981. This is accounted for in the development planning.

# UNCLASSIFIED

# UNCLASSIFIED

(U) Analyses of the future needs of ballistic missile, MX, and submarine-launched ballistic missile (SLBM) development programs indicate that, in addition to a continued need for ARIA-type support, three additional P-3 SMILS aircraft will be required to provide RV impact scoring in the Pacific for MX and TRIDENT testing. Moreover, the frequent use of multiple IRVs by both MX and TRIDENT launches requires the use of multiple ARIA when there is insufficient time spacing between IRVs, due to the single-object capability of the current telemetry nose dish. Previous analyses have shown (and have been verified in this report) that sufficient multiple aircraft missions can be avoided by using a multibeam ARIA Phased-Array Telemetry System (APATS) to reduce the ARIA fleet of eight by two aircraft and to amortize the development and acquisition costs.

(U) Finally, the user's time-on-station needs at various BOAs require the aging EC-135N(A) ARIA fleet to be upgraded either by reengining or by using an alternate aircraft that offers better performance. More stringent ICAO noise and pollution standards being imposed on commercial aircraft also contribute to this upgrade requirement.

(U) Current plans call for the additional Pacific SMILS aircraft to be provided by the PMTC to satisfy the near-term and future support needs of MX and TRIDENT. The P-3A aircraft, recently assigned to PMTC, will be provided with the necessary SMILS, supplemental telemetry and optics equipment for this support. Additionally, PMTC is acquiring four P-3A aircraft for the EATS AIS equipment installation, which will include a multibeam phased-array telemetry antenna.

(U) The separate baseline aircraft resources needed to support the projected workload total 17 aircraft (8 ARIA, 5 P-3 SMILS, and 4 P-3 EATS). Also, basic similarities between the ARIA/APATS and the EATS phased-array telemetry antennas stimulated questions on the potential for the EATS resources to be upgraded to provide ballistic missile testing so that these multimillion-dollar development resources could be used more efficiently. The DoD community considered various alternatives that involved consolidating functions onto fewer aircraft, as

from  
Pacific  
Missile  
Test  
Center

from vol II

# UNCLASSIFIED

(U)

well as various modifications for adapting the EATS telemetry antenna to accommodate the ICBM support mission.

(U) Under guidance by OUSDRE/DDTE, the SSTSS Working Group designated a special study group (October 1980) to examine the potential and options regarding a Universal Range Instrumentation Aircraft (URIA). SRI International, who was initially contracted to provide analytic and technical support to the Working Group, was given a separate three-month (February-April 1981) task to conduct the URIA study under the direction and support of the URIA study group. The URIA study group members consisted of representatives from PMTC, the 4950th TW, BMSDCOM-R, Headquarters USAF, and Headquarters AFSC. The group was chaired by 1st Lt. R. S. Hassan, SAMTO/DOS.

(U) The results of the URIA study are documented in a separate SRI report<sup>3</sup> and are summarized here for integration into the overall SSTSS results.

(U) The URIA study objectives were to:

- (U) Technically and operationally examine viable options for satisfying users with mobile support needs by consolidating aircraft functions to configure a more efficient and cost-effective national resource.
- (U) Recommend and substantiate a preferred fleet configuration through cost/benefit analyses.
- (U) Define the budget profile required to achieve the recommended approach.

(U) Embodied in these objectives was the evaluation of the economic viability of a URIA, which combines all instrumentation functions on a single aircraft. The approach to achieving the above objectives involved the following steps:

- (U) Define future mission support requirements.
- (U) Identify the resources and various options to be analyzed.
- (U) Define the PME payloads for the various options.

# UNCLASSIFIED

(U)

- (U) Screen aircraft and reengining alternatives that might serve as a URIA platform with regard to performance and cost.
- (U) Develop aircraft workloads for each option.
- (U) Perform a life-cycle cost analysis of each option using the most appropriate aircraft alternative(s).
- (U) Interpret the results of the analyses and recommend the preferred option(s), indicating the required investment and operations and support (O&S) budgetary profiles.

(U) The scope of the URIA study included mobile aircraft resources that were principally involved in the test support of strategic weapons test and evaluation (T&E), but did not cover general-purpose range support aircraft. The EATS AIS was included because of its potential to support ballistic missile terminal area events. The timeframe considered for this study covers 1982-through-1999. At the outset of this study, it was agreed with OUSDRE/DDTE to identify a preferred aircraft resource configuration. The finalized design and implementation details would subsequently be provided to the cognizant service.

## 2. URIA Requirements Analysis Results (U)

### a. Programs to Be Supported (U)

(U) The information on the strategic system tests to be supported and the functional and operational requirements imposed on mobile instrumentation aircraft were drawn principally from the Air Force, Army, and Navy user requirements documented in Section II. The URIA study group's review of these data identified the following programs to be supported by the URIA:

- (U) Ballistic missile development and operational testing:
  - Navy--TRIDENT (C-4), (C-5), POSEIDON
  - Air Force--MX
  - Army--PERSHING.
- (U) NASA/DoD--satellite and space programs.
- (U) Cruise missile development and OT.

# UNCLASSIFIED

(U)

- (U) Navy Fleet exercise support and air-air/air-surface tactical weapons T&E at PMTC. (This item is included because the EATS aircraft were considered for consolidation.)

b. Functional Requirements (U)

(U) The URIA study report listed the functional support needs of each user program so that instrumentation payloads could be defined for the various aircraft configuration options identified. The principal instrumentation functions (summarized in Table 24) are:

- (U) Telemetry
- (U) Scoring
- (U) Streak optics
- (U) Meteorology
- (U) Data relay
- (U) Command and control
- (U) Metric tracking (EATS support only).

(U) Significant differences in the telemetry requirements of the URIA study are the ARIA's need for dual polarization on multiple IRVs and telemetry reception to reduce the effects of deep antenna nulls on the spinning RV, while single polarization is adequate for the EATS telemetry system. This is one reason for basic design differences in the EATS and ARIA phased-array telemetry systems. Another significant difference in the telemetry requirement, which is not evident in Table 24,



Table 24

## (U) URIA FUNCTIONAL SUPPORT REQUIREMENTS

Program	Telemetry	Scoring	Streak Photo	Meteorology	Data Relay	Metric	Command/Control
Air Force ICBM	Up to 4 IRVs Avoid blackout Dual polarization	All RVs	Re-entry	(Desired)	--	--	--
Navy SLBM	Up to 4 IRVs Blackout tolerated with delay link Dual polarization	All RVs	Re-entry	(Desired)	--	--	--
Cruise missile ALCM/GLCM	Single object	--	--	--	Real-time L-band telemetry	--	FTS*
Army IRBM†		--	--	--	Real-time	--	--
NASA/DoD	Single object	--	--	--	Voice/telemetry relay	--	--
Fleet exercise (EATS)	Up to 10 objects Single polarization	--	--	--	Secure data	Many objects Multilateration of transponder- equipped objects	ITCS‡
Tactical missile T&E (EATS)	1 to 7 objects Single polarization	--	--	--	Secure data	1 to 7 objects Single polarization	ITCS

\* Flight Termination System.

† Intermediate range ballistic missile.

‡ Integrated Target Control System.

UNCLASSIFIED

UNCLASSIFIED

109

UNCLASSIFIED

(U)

is the ARIA's need for higher altitude (greater telemetry beam elevation angles) for RV reentry coverage than is required for the EATS support role. These differences (polarization and elevation coverage) necessitate an upgrade of the EATS phased-array telemetry antenna to accommodate the ballistic missile test support role. Conversely, the APATS antenna would require changing from four beams to five beams to accommodate the EATS mission.

(U) The only functional commonality between EATS mission needs and the other program needs is the telemetry function. Metric tracking is EATS-peculiar and necessitates a specialized multilateration interrogator/transponder system on the AIS. <sup>extended area test system</sup> The EATS relay (to remote ground stations) of secure data also uses hardware dissimilar to that required for the long-range satellite voice/data relay needs of the NASA/DoD space programs. Finally, the EATS command control transmissions for the integrated target control system (ITCS) at PMTC is uniquely integrated into the EATS multilateration message formats. This concept is distinctly different from the flight termination system (FTS) needs of the ALCM program. <sup>airborne instrument system</sup>

(U) The functions of scoring (SMILS), streak photography, and meteorology are also unique requirements of ballistic missile test support and will necessitate specialized hardware/subsystems on aircraft performing those support roles.

(U) Thus, for aircraft options performing multiple mission roles, a consolidated PME suite was defined to permit costing and aircraft payload weight estimating.

c. Operational Requirements (U)

(U) The operational support requirements relative to aircraft performance are of principal concern. These requirements were assessed for each mission type in terms of aircraft range and time-on-station. Also assessed were staging area proximity, facilities, and runway lengths.

# UNCLASSIFIED

(U)

Generic altitude profiles of each mission type and any specialized aircraft requirements imposed by particular test support geometries were also defined.

EX 5

(U) Cruise missile test support is stressing from the standpoints of long endurance (5-10 h) and high speed (Mach 0.7), as well as the geometric difficulty for an aircraft to maintain a tail-chase throughout the missile's winding trajectory. This trajectory is accommodated most easily by an aircraft with a forward-looking, steerable telemetry antenna, such as the nose-mounted antenna on the current ARIA. Side-looking phased arrays (like EATS and APATS) will have more coverage difficulty with this mission.

(U) A unique operational requirement imposed by the EATS aircraft support geometry for fleet exercise and tactical missile T&E missions is the need for phased-array telemetry antennas that provide coverage from both sides of the aircraft. This need exists because the metric tracking function requires the AIS to maintain a stationkeeping position in good multilateration geometry with both RVs and land stations, rather than allowing the aircraft to circle the test area. Thus, alternate

---

2

# UNCLASSIFIED

(U)

sides of the AIS aircraft are exposed to the RVs for telemetry collection. Since it is cost-effective to put the telemetry antenna and the tracking function on the same aircraft, a two-faced array is required. If the position of the AIS for best multilateration geometry relative to land-based reference stations is not critical, it may be feasible for the AIS to orbit the test arena circularly, requiring only a one-faced antenna. This implies that sufficient aircraft altitude can be maintained to preserve a line-of-sight to the land stations. This aspect was not investigated.

### 3. URIA Study Options (U)

#### a. Option Definitions (U)

(U) Seven aircraft configuration options were identified for the URIA study. These options represent a rational set of asset transition alternatives from current resources and also take advantage of existing or planned aircraft instrumentation system programs, such as APATS and EATS. The options range from simple functional consolidations to a full URIA concept. All options were technically defined and the fleets appropriately sized so that each would be capable of supporting future user requirements and workloads. Table 25 lists the options, indicates the number of differently configured aircraft in each fleet, and designates the user mission each option would support.

(U) The fleet sizes established were a function of:

- (U) The maximum number of simultaneous aircraft of a given capability required per single mission.
- (U) Spare aircraft (if any) to ensure at least an 0.85 probability that the required number of aircraft would support a mission.
- (U) Additional aircraft reserves for airframe and PME maintenance (for heavily worked fleets).
- (U) Additional aircraft needed to accommodate workload peaking for simultaneous missions.

Table 25

(U) URIA STUDY OPTIONS, FLEET SIZES, AND SUPPORT ROLES

Option	Aircraft Instrumentation						Total No. of Aircraft
	707 ARIA		P-3 SMILS		P-3 EATS		
	No. of Aircraft	Missions Supported	No. of Aircraft	Missions Supported	No. of Aircraft	Missions Supported	
I BASELINE	8	ICBM BOA* NASA/DoD satellite Cruise missile	5	ICBM Scoring*	4	Fleet exercises Tactical missile T&E	17
II ARIA/APATS	6	ICBM BOA* NASA/DoD satellite Cruise missile	5	ICBM Scoring*	4	Fleet exercises Tactical missile T&E	15
III EATS(U)/SMILS	4	NASA/DoD satellite Cruise missile		--	7	Fleet exercises Tactical missile T&E ICBM BOA*	11
IV ARIA/APATS/SMILS	6	ICBM BOA* NASA/DoD satellite Cruise missile		--	4	Fleet exercises Tactical missile T&E	10
V ARIA/SMILS	8	ICBM BOA* NASA/DoD satellite Cruise missile		--	4	Fleet exercises Tactical missile T&E	12
VI URIA	9	ICBM BOA* NASA/DoD satellite Cruise missile Fleet exercises Tactical missile T&E		--		--	9
VII EATS (U)/SMILS & ARIA/SMILS	6	Single IRV BOA missions* NASA/DoD space & satellite Cruise missile		--	4	Multi-IRV BOA missions* Fleet exercises Tactical missile T&E	10

\* Atlantic and Pacific oceans

UNCLASSIFIED

UNCLASSIFIED

113

UNCLASSIFIED

# UNCLASSIFIED

(U) Option 1 (Easeline) involves upgrading the EC-135N aircraft of the existing ARIA fleet (six EC-135Ns and two C-135Bs) to maintain the same roles and missions and to meet future requirements. Performance comparisons for the EC-135N upgrade alternatives are discussed below. Option I includes the five P-3 SMILS aircraft (two at VX-1 and three at PMTC) required for ICBM scoring support. The four EATS P-3 aircraft are retained for the original EATS workload.

(U) Option II (ARIA/APATS) examines the value of APATS. It retains the same mission allocation as Option I but adds APATS to four of the upgraded ARIA, which permits reducing the ARIA fleet to six aircraft. The P-3 SMILS and EATS aircraft are retained in their baseline roles.

(U) Option III (EATS[U]/SMILS) examines the utility of consolidating the SMILS scoring function of the EATS P-3s and upgrades the EATS telemetry antenna (to an APATS equivalent) for the ballistic missile support role. The EATS P-3A aircraft are also upgraded to be equivalent to P-3Bs. This expanded mission for the EATS(U)/SMILS aircraft requires a fleet of seven aircraft at PMTC, but eliminates separate East and West Coast P-3 SMILS assets and permits reducing the ARIA fleet to four aircraft. Option III avoids the APATS program, but involves a significant change in agency historical mission support. It removes the ballistic missile support role from the ARIA (4950th TW), leaving those missions (NASA/DoD space and cruise missile) that cannot be readily accommodated by the upgraded P-3 aircraft. It also requires PMTC to support both Atlantic and Pacific Ocean programs.\*

(U) Option IV (ARIA/APATS/SMILS) leaves the EATS aircraft as planned for the EATS workload. The ARIA is upgraded with APATS, and a SMILS capability is incorporated. This configuration reduces the number of aircraft required by the nation from 17 (baseline) to 10. It also avoids significant shifts in agency mission support responsibility.

---

\* (U) The technical feasibility of an upgraded EATS telemetry antenna performing the BOA support is discussed in Section VII-A, EATS/APATS Telemetry Performance Comparisons.

# UNCLASSIFIED

(U) Option V (ARIA/SMILS) also keeps the SMILS RV scoring capability on the ARIA aircraft to eliminate the need for separate RV scoring aircraft. APATS is not developed, thus the fleet of eight ARIA is retained. Also, the EATS aircraft resources are left undisturbed at PMTC. The value of an APATS can again be assessed by comparing Option IV to Option V.

(U) Option VI (URIA) examines the feasibility of a truly universal range aircraft--one fleet of identical aircraft to support all missions. This requires that instrumentation equipment and capabilities for all missions be consolidated on a single aircraft. Nine such URIA would be required. The most difficult aspect of this option is the need to upgrade the APATS four-beam, single-faced phased array to a five-beam, dual-faced array (dubbed "super-APATS") to accommodate the EATS design requirement. During the URIA study, neither the EATS nor the APATS antenna design requirements were challenged, as it was beyond scope.

(U) Option VII (EATS[U]/SMILS and ARIA/SMILS) was added, at the request of the SSTSS Executive Committee, to consider a mixture of Option V (ARIA/SMILS) and Option III (EATS[U]/SMILS). This option would preserve for the nation the 4950th TW experience and the growth potential of their larger aircraft, while offering the users a cost-effective, multibeam phased-array, EATS(U), when required for multiple-IRV BOA missions. In Option VII, the ballistic missile workload was divided between the nose-dished ARIA/SMILS (single-IRV missions) and the EATS(U)/SMILS (multiple-IRV missions). The feasibility of this option (as well as Option III) is dependent on the success of the EATS telemetry upgrade and PMTC's support of both Atlantic and Pacific Navy and Air Force missions. Table 26 provides the fleet sizing rationale used for the various URIA options.

# UNCLASSIFIED

Table 26  
(U) FLEET SIZE ESTIMATES

Driving Factor	Option																				
	I Baseline			II ARIA/APATS			III EATS(U)/ SMILS			IV ARIA/APATS SMILS			V ARIA/ SMILS			VI URIA			VII EATS(U)/SMILS + ARIA/SMILS		
	A*	S*	E*	A	S	E	A	S	E	A	S	E	A	S	E	A	S	E	A	S	E
Maximum #/mission	4	1/2 <sup>†</sup>	3	2	1/2	3	2 <sup>④</sup>	--	3	2	--	3	4	--	3	5 <sup>⑦</sup>	--	--	2 <sup>④</sup>	--	3
0.85/0.95 probability of availability	1/1	0/1-0/1	1/1	0/1	0/1-0/1	1/1	0/1	--	1/1	0/1	--	1/1	1/1	--	1/1	1/2	--	--	1/1	--	1/1
Spare aircraft for airframe main/mod	1	0	0	1	0	0	1 <sup>①</sup>	--	1	1 <sup>①</sup>	--	0	1	--	0	1	--	--	1	--	0
Spare aircraft for PME main/mod	1 <sup>①</sup>	0 <sup>②</sup>	0	1	0 <sup>②</sup>	0 <sup>②</sup>	0 <sup>⑤</sup>	--	1	1 <sup>①</sup>	--	0 <sup>②</sup>	1	--	0	1	--	--	0 <sup>②</sup>	--	0 <sup>②</sup>
Spare aircraft for Peak workload	1	0	0	2 <sup>④</sup>	0	0	1	--	1	2 <sup>④</sup>	--	0	1	--	0	1	--	--	2 <sup>④</sup>	--	0
Total	8	2-3	4	6/7	2/3	4	4/5	--	7 <sup>⑦</sup>	6/7 <sup>④</sup>	--	4	8	--	4	9/10	--	--	6	--	4

\*A = ARIA, S = P-3 SMILS, E = EATS

<sup>†</sup>Slash refers to Atlantic-Pacific.

- (1) Historical use of spares for maintenance and peak workloads.
- (2) Airframe and PME maintenance can be scheduled around score events.
- (3) 2/1 mix of APATS/non-APATS requires 2 backups of standard ARIA or 1 backup of APATS/ARIA.
- (4) Maximum of 2 aircraft per mission for cruise missile support.
- (5) Since (~60%) less workload, PME maintenance spare not required; assumed schedule around events.
- (6) Includes one non-EATS(U), i.e., EATS aircraft.
- (7) Maximum of 5 aircraft up is due to requiring support of any two major missions: Fleet exercises (3), cruise missile (2), or dual MX BOAs (2).
- (8) Assumes mix of APATS/ARIAs is 4 APATS/ARIA and 2 non-APATS.

UNCLASSIFIED



# UNCLASSIFIED

## b. Prime Mission Electronics Payload Definitions (U)

(U) The URJA study group required PME payloads to be established for each aircraft type in the option configurations. The specific complement of PME varied with the missions to be supported and, in some cases, with the aircraft used. These payloads, weights, and volumes were basic considerations in evaluating the candidate aircraft for either upgrading the aging EC-135N ARIA or for the URJA. As it turned out, the same aircraft upgrade used for the ARIA was also acceptable for the URJA role.

(U) Eight aircraft configuration variants were involved, each requiring a different set of PME. These aircraft types are: basic ARIA, basic SMILS, basic EATS, ARIA with APATS, ARIA with SMILS, ARIA with APATS and SMILS, EATS (upgraded) with SMILS, and the URJA. Table 27 summarizes the PME payloads according to the various subsystem elements required for each of seven aircraft/mission roles. These payload totals were added to the basic empty weight of a given aircraft type.

(U) The reason for large payload differences between aircraft having similar mission roles (such as 20,497 lb for EATS[U]/SMILS, and 33,873 lb for ARIA/APATS/SMILS) was the subject of particular scrutiny. Basically, the differences stemmed from different weights for racks and cables; ARIA racks are stressed for a 9-g load (400-500 lb each), and the EATS racks (120 lb each) are not. Also, the ARIA's additional PME subsystems (such as real-time data relay consoles), which have proved valuable by past experience and which are required on the NASA/DoD space support events, contributed to the heavier ARIA payload.

## c. Aircraft Platform Analysis (U)

(U) Various aircraft platforms were analyzed to establish the best aircraft or engine upgrade alternative for ARIA or URJA candidates. In addition to ARIA/URJA aircraft alternatives, the capability of the P-3B (upgraded P-3A) to handle the EATS(U)/SMILS payload in the ballistic missile support role was also investigated.

Table 27

## (U) URIA OPTION PAYLOAD SUMMARY (1b)

Payload Element	Option							
	I, III Current ARIA	II ARIA/ APATS	I, II SMILS	I, II, V EATS	III, VII EATS(U)/ SMILS	IV ARIA/ APATS/ SMILS	VI URIA	V, VII ARIA/ SMILS
TM antenna								
Nose dish	1,413						1,413	1,413
APATS		5,000*				5,000*		
Super APATS							8,000*	
EATS				2,250				
EATS(U)					4,539			
Communication	3,366	3,366				3,366	3,366	3,366
Mission control	1,379	800				800	1,379	1,379
TM-receiver group	2,062	2,062		1,162	1,440	2,062	2,062	2,062
Record/timing	3,179	3,179	152	885	1,592	3,179	3,179	3,179
Data separation and voice relay	5,385	5,385				5,385	5,385	5,385
Tracking/multilateration SMILS				512	512		512	
Supplementary TM <sup>†</sup>			2,582		2,582	2,582	2,582	2,582
Optics			457		457	457	457	457
Crew size (250 lb each)	(18)	(18)	(15)	(8)	(19)	(22)	(22)	(22)
Miscellaneous equipment and modifications	2,652	2,652	1,172	1,777	1,777	2,652	2,652	2,652
Residual ASW/avionics			3,105	3,105	3,105			
Seats, bunks, etc.	2,575	2,575				2,575	2,575	2,575
Total payload (lb)	26,511	29,519*	11,618	11,691	20,754	33,558*	39,162*	30,550

\* Estimated weights; systems not designed.

<sup>†</sup> For MX support at KMRN only.

UNCLASSIFIED

UNCLASSIFIED

118

UNCLASSIFIED

# UNCLASSIFIED

(U) The aircraft alternatives identified for capability comparisons for the ARIA and URJA missions and payloads consisted of all plausible four-engined United States aircraft, which were grouped into small, medium, and large airframes. In addition to alternative aircraft, two reengining alternatives were examined for the EC-135N ARIA. These aircraft are listed in Table 28, which also indicates those aircraft eliminated in a preliminary screening because of performance limitations or excessive cost.

(U) As is indicated in Table 27, all small aircraft and some of the medium-sized aircraft were rejected due to insufficient airframe performance.

(U) The preliminary performance screening was made by calculating the TOS provided by each candidate using the URJA (39,377 lb) payload for a stressing support scenario. These calculations were optimistic in that no staging area runway constraints (which can impose fuel off-loading) or drag penalties were imposed.

(U) Large aircraft, which provided the needed TOS capabilities were rejected because of comparatively excessive acquisition and POL/maintenance costs for a sample 10-yr period. An average of 250 flight hours per year was used for representative purposes. Small aircraft were unable to provide the required TOS.

2

NOTES:

- ARIA MISSION RULES
- NOSE DISH ON AIRCRAFT
- JP-4 FUEL
- ARIA + SMILS PAYLOAD
- AIRCRAFT

- ⊙ EC-135N (A)
- EC-135B or EC-135N (RE: JT-3D-3B)
- ▲ EC-135 (RE: CFM-56)
- △ DC8-62CF
- 707-320C

UNCLASSIFIED

FIGURE 20 (U) TIME-ON-STATION FOR REPRESENTATIVE SUPPORT AREAS--  
ARIA/APATS/SMILS PAYLOAD (33,900 lb)

---

\* (U) This could pose a growth problem for the P-3B, because the inclusion of the EPS-SMILS equipment (being developed by WSMC) will require an additional 2000 lb.

X

# UNCLASSIFIED

(U)

- (U) The CFM-56 reengine alternative for the EC-135N ARIA offers better TOS and a lower O&S cost than the 707, but requires a very large investment (\$22.5M per aircraft). Reengining the old EC-135N would not provide the fuselage growth volume offered by the 707-320C.
- (U) The JT-3D-3B reengining alternative for the EC-135N would not produce the required airframe performance (i.e., similar to the C-135B).
- (U) Small aircraft alternatives do not provide the required range and payload performance and were eliminated.
- (U) Large aircraft provide more TOS and better range performance than needed, but are inordinately expensive for both acquisition and operation.
- (U) The P-3B (P-3A upgraded) provides the desired 5.5 h TOS with the EATS(U)/SMILS payload (20,000 lb) if operated in the "heavy" mode (i.e., maximum gross take-off weight at the design limit 139,000 lb) which requires a waiver; however, it cannot accommodate the full ARIA/URIA payload weight (34,000 to 39,000 lb) or volume. Neither can it be used for ALCM or NASA/DoD space support due to speed limits and the need for extra PME weight. It offers virtually no growth potential for future ARIA-type mission needs. P-3A to B conversion costs are reasonable (i.e., \$2.8M per aircraft).

(U) In consideration of the above conclusions, all ARIA or ARIA variants used in the URIA study options employed a 707-320C aircraft. Also, for all study options involving P-3A aircraft (Options I and II PMTC SMILS and all standard EATS aircraft), it assumed that the T56-A-10W engines would be modified to a T56-A-14 in the post-1985 timeframe to ensure continued maintainability due to probable discontinuance of the T56-A-10 engine in the Navy's P-3 inventory. Finally, the P-3A aircraft must be upgraded to a P-3B equivalent to perform the EATS(U)/SMILS ballistic missile support in Options III and VIII.

#### 4. Option Cost Trade-Off and Ranking (U)

##### a. URIA Study Cost Summary (U)

This section summarizes the results of the URIA study economic analysis. Additional details concerning methodology and input data are provided in the URIA Study Final Report.<sup>3</sup>

# UNCLASSIFIED

(U) The objective of the economic analysis was to rank the options in terms of their LCCs over the 18 years (FY82-99) for which workloads were forecast and to determine which were the most cost effective. Table 29 summarizes each option's fleet composition and mission support capabilities that served as a basis for LCC. The LCCs in this analysis were organized to reflect total cost to the nation, both in constant FY80 dollars and discounted dollars. A secondary objective of the analysis was to examine the sensitivity of LCC results to changes in key inputs or assumptions.

(U) A work breakdown structure (WBS), which provides the granularity needed to validate costs for different items serving similar functions, or for similar items whose costs were obtained from different sources, is provided in Table 30. Nonrecurring engineering and design, hardware acquisition, and airframe modification costs (appearing only once in the service life of a system), were charged to each option during the years in which the costs were expected to occur. Fixed annual costs (e.g., personnel salaries and facility maintenance) and variable recurring expenses directly attributable to test support were also included.

(U) Variable costs (e.g., cost per flying hour, crew per-diem expenses, and per-event expendables) were multiplied by the appropriate annual workload factor for each concept to determine annual variable costs.

(U) The input data for fixed annual and variable costs were compiled from four primary sources:

- (U) 4950th Test Wing's manning and cost factors for the ARIA fleet.
- (U) Historical aircraft maintenance and flying hour costs experienced by PMTC with the P-3As based at Pt. Mugu.
- (U) "USAF Cost and Planning Factors Pamphlet," AF Pamphlet 1973-13 (1 February 1980).
- (U) "Navy Program Factors Manual," Vol. 1, OPNAV-90P-02C (revised 31 October 1979).

Table 29

## (U) SUMMARY OF FLEET CONFIGURATIONS FOR OPTIONS I - VII

Fleet Composition			Mission Support Capability							
Option	Aircraft	Fleet Size	Nose Dish	Horn	APATS	UPATS*	EATS	EATS(U)	SMILS Support	EATS Support
IA	EC-135N(B) ARIA	2	2							
	EC-135N(RE) ARIA	6	6							
	P-3A SMILS	3		1					3	
	P-3C SMILS	2		1					2	
	P-3A EATS	4						4		4
	Total	17	8	2				4/4		5
IB	EC-135N(B) ARIA	2	2							
	707 ARIA	6	6							
	P-3A SMILS	3		1					3	
	P-3C SMILS	2		1					2	
	P-3A EATS	4						4		4
	Total	17	8	2				4/4		5
II	707 ARIA APATS	6	6		4					
	P-3A SMILS	3		1					3	
	P-3C SMILS	2		1					2	
	P-3A EATS	4						4		4
	Total	15	6	2	4			4/4		5
III	707 ARIA	4	4							
	EATS(U) SMILS	4						4	4	4
	P-3A EATS	3					3		4	3
	Total	11	4				3/3	4	4	7
IV	707 ARIA	2	2							
	707 ARIA/APATS/ SMILS	4	4		4				4	
	P-3A EATS	4					4		4	4
	Total	10	6		4		4/4		4	4/4
V	EC-135N(B)ARIA	2	2							
	707 ARIA	2	2							
	707 ARIA SMILS	4	4						4	
	P-3A EATS	4					4		4	4
	Total	12	8				4/4		4	4/4
VIA	URIA	9	9				9		9	9
	Total ARIA	9	9				9/9		9/9	9/9
VIB	707 ARIA	1	1							
	707 ARIA APATS/ SMILS	4			4				4	
	707 EATS	4					4		4	4
	Total	9	1		4		4/4		4	4/4
VII	707 ARIA	3	3							
	707 ARIA/SMILS	3	3						3	
	EATS(U) SMILS	3						3	3	3
	P-3A EATS	1					1		6	1
	Total	10	6				1/1	3	6	4

\*UPATS is an upgraded APATS with 5 beams and 2 faces for URIA.

UNCLASSIFIED

UNCLASSIFIED

125

UNCLASSIFIED

# UNCLASSIFIED

## b. Workload Summary (U)

(U) The basic workload unit used in the URIA study is the terminal area test event.

The detailed test event schedules and locations were summarized in Table 4. Each terminal area test event involves some combination of factors, such as the number of IRVs to be tracked, the location of the event, and the nearest staging point. These factors can be translated into cost-generating variables for aircraft, e.g., number of aircraft, flight hours per aircraft, and crew per-diem days. While the total number of test events per year is a constant for all options, the cost generating variables change with each option.

(U) Table 31 defines the average single-aircraft flight hours and crew per-diem days required (and used in this cost analysis) for each type of support event as a function of aircraft type, event type, and support location. The EATS test support program is presented independently in Table 32, showing flight hours and per-diem days for an EATS aircraft based on PMTC, Pt. Mugu, California. For options supporting EATS with aircraft based at WPAFG, Ohio (e.g., Option VI, URIA) 8 flight hours and 2 per-diem days must be added to each EATS aircraft event in Table 32. Multiplying the basic terminal area test event data by Table 31 data and adding Table 32 data yields the annual workload totals for each aircraft type in each of the options analyzed (see Table 33).

## c. Cost Estimates for Alternative Concepts (U)

(U) As discussed earlier in this report, an ARIA fleet incorporating the 707-320C airframe was used as the baseline against which the remaining URIA options were compared. Nonrecurring and recurring costs for WBS elements needed to calculate LCCs for the aircraft included in alternatives to baseline (Options II through VII) are listed in Tables 34 and 35, respectively. The minimum investment which must be incurred in baseline assets to provide the required test support until an option is operational is listed as the "transition" cost of that option. Time



Table 31

(U) FLIGHT HOURS AND CREW PER-DIEM DAYS PER AIRCRAFT SUPPORT EVENT

Aircraft	Pacific Ballistic Missiles						Atlantic Ballistic Missiles								Satellites		Other	Cruise Missiles	
	KMRN	BOA-1	BOA-2	BOA-3	Wake	Oeno	C9	C11	C12	C15	C16	C18	ASC	Antigua	ETR	WTR			
ARIA EC-135N (B)																			
Flight hours		44	44	50	44	40	21	21	28	14	31	--	31	21	35	38	23.3	16	
Crew per diem days		8	8	10	8	8	4	4	5	3	6	--	6	4	7	8	5	10	
ARIA EC-135N (RE)																			
Flight hours		44	44	50	44	40	21	21	28	14	31	--	31	21	--	--	--	--	
Crew per diem days		6	6	6	6	5	4	4	4	3	4	--	4	3	--	--	--	--	
ARIA 707 320C*																			
Flight hours		44	44	50	44	40	21	21	28	14	31	--	31	21	35	38	23.3	16	
Crew per diem days		6	6	6	6	5	4	4	4	3	4	--	4	3	7	8	5	10	
ARIA 707 APATS																			
Flight hours		44	44	50	44	40	21	21	28	14	31	--	31	21	--	--	--	--	
Crew per diem days		6	6	6	6	5	4	4	4	3	4	--	4	3	--	--	--	--	
ARIA 707 SMILS																			
Flight hours	45.5	45.5	45.5	50	45.5	41.5	22.5	22.5	29.5	15.5	32.5	--	--	--	--	--	--	--	
Crew per diem days	6	6	6	6	6	5	4	4	4	3	4	--	--	--	--	--	--	--	
ARIA 707 SMILS/APATS																			
Flight hours	45.5	45.5	45.5	50	45.5	41.5	22.5	22.5	29.5	15.5	32.5	--	--	--	--	--	--	--	
Crew per diem days	6	6	6	6	6	5	4	4	4	3	4	--	--	--	--	--	--	--	
PMTc P-3A/B SMILS																			
Flight hours	32	41	45	50	31	41	16	31	31	14	43	--	--	--	--	--	--	--	
Crew per diem days	6	7	7	9	5	7	3	7	7	3	7	--	--	--	--	--	--	--	
VX-1 P-3C SMILS																			
Flight hours	32	41	45	50	31	41	16	31	31	14	43	--	--	--	--	--	--	--	
Crew per diem days	6	7	7	9	5	7	3	7	7	3	7	--	--	--	--	--	--	--	
PMTc P-3B EATS(U)/SMILS																			
Flight hours	32	41	45	50	31	41	28	43	43	26	55	--	45	24	--	--	--	--	
Crew per diem days	6	7	7	9	5	7	5	9	9	5	9	--	9	5	--	--	--	--	

UNCLASSIFIED

UNCLASSIFIED

128

UNCLASSIFIED

Table 32

(U) P-3A/B SUPPORT REQUIREMENTS:  
AIRCRAFT EVENTS, FLIGHT HOURS, AND CREW PER-DIEM DAYS

Type of Event	Fiscal Year									
	82	83	84	85	86	87	88	89	90	91-99
Aircraft Events		4	4	8	18	12	12	13	13	13
Flight Hours <sup>†</sup>		160	240	330	360	546	588	675	675	675
Crew PDD		3	3	6	6	9	9	9	9	9
Air-to-Air/Surface										
Aircraft Events		10	10	10	10	10	10	10	10	10
Flight Hours		50	50	50	50	50	50	50	50	50
Surface-to-Surface										
Aircraft Events		22	24	18	5	4	4	4	4	4
Flight Hours		110	120	90	25	20	20	20	20	20
Surface-to-Surface										
Aircraft Events		15	13	13	13	13	13	13	13	13
Flight Hours		75	65	65	65	65	65	65	65	65
Aircraft Events		1	2	2	2	2	2	2	2	2
Flight Hours		3	4	6	6	6	6	6	6	6
Total Flight Hours		398	481	541	506	687	725	816	816	816
Total Crew Days		3	3	6	6	9	9	9	9	9

<sup>†</sup>P-3A/B EATS stages out of PMTC.<sup>‡</sup>Assumes 5 FHs per event.<sup>§</sup>Assumes 3 FHs per event.

UNCLASSIFIED

UNCLASSIFIED

129

UNCLASSIFIED

Table 33

## (U) WORKLOAD SUMMARY--URIA OPTIONS

Option	1982	1983	1984	1985	1986	1987	1988	1989	1990	1991	1992	1993	1994	1995	1996	1997	1998	1999	Total
<b>Option I--Baseline</b>																			
707 ARIA																			
Missions	95	61	58	60	46	68	66	74	59	51	49	40	48	48	47	49	44	36	999
Flight hours	1242	1344	1524	1422	1016	1899	1817	2066	1638	1534	1511	1205	1442	1507	1404	1506	1322	1102	26,501
Crew per diem days	411	347	348	341	273	396	386	431	339	315	309	266	302	309	294	313	281	250	5,911
P-3 SMILS																			
Missions	8	15	19	22	12	30	27	35	27	24	26	22	25	26	25	22	23	18	416
Flight hours	179	404	636	717	352	1072	961	1174	864	832	901	733	882	877	853	748	791	631	13,607
Crew per diem days	36	36	58	57	44	61	40	77	67	58	61	47	62	61	65	44	51	34	959
EATS (basic)																			
Missions	--	52	53	51	38	41	41	42	42	42	42	42	42	42	42	42	42	42	738
Flight hours	--	1398	481	541	506	687	725	816	816	816	816	816	816	816	816	816	816	816	12,314
Crew per diem days	--	3	3	6	6	9	9	9	9	9	9	9	9	9	9	9	9	9	135
<b>Option II--ARIA/APATS</b>																			
707 ARIA/APATS																			
Missions	95	61	48	49	33	45	42	48	37	34	36	32	35	36	35	32	33	28	759
Flight hours	1242	1344	1149	1175	625	1130	1061	1258	974	925	1003	857	993	983	953	877	911	754	18,214
Crew per diem days	411	347	296	299	215	282	278	317	244	235	250	231	236	250	239	228	231	203	4,792
P-3 SMILS																			
(Same as Option I)																			
EATS (basic)																			
(Same as Option I)																			
<b>Option III--EATS(U)/SMILS</b>																			
707 ARIA																			
Missions	95	61	58	24	18	16	16	16	12	12	12	12	12	12	12	12	12	12	424
Flight hours	1242	1344	1524	507	290	256	256	256	192	192	192	192	192	192	192	192	192	192	7,595
Crew per diem days	411	347	348	203	168	160	160	160	120	120	120	120	120	120	120	120	120	120	3,157
P-3 SMILS																			
Missions	8	15	19	--	--	--	--	--	--	--	--	--	--	--	--	--	--	--	42
Flight hours	179	404	636	--	--	--	--	--	--	--	--	--	--	--	--	--	--	--	1,219
Crew per diem days	36	36	58	--	--	--	--	--	--	--	--	--	--	--	--	--	--	--	130
EATS(U)																			
Missions	--	52	53	78	54	76	72	79	69	66	68	64	67	68	67	64	65	60	1,122
Flight hours	--	398	481	1510	1046	2007	1878	2218	1836	1768	1849	1657	1818	1825	1801	1660	1715	1519	26,986
Crew per diem days	--	3	3	109	107	242	208	263	189	183	193	161	190	193	190	163	172	137	2,776
<b>Option IV--ARIA/APATS/SMILS</b>																			
707 ARIA/APATS/SMILS																			
Missions	95	61	58	60	32	53	47	53	39	36	38	34	37	38	37	34	35	30	817
Flight hours	1242	1344	1524	1422	685.5	1424.5	1321.5	1530.5	1102.5	1049.0	1130.0	978.0	1118.5	1110.0	1078.5	998.0	1033.0	869.0	20,960.5
Crew per diem days	411	347	348	341	221	316	302	341	250	241	250	231	248	250	245	234	237	215	5,028
P-3 SMILS																			
Missions	8	15	19	22	--	--	--	--	--	--	--	--	--	--	--	--	--	--	64
Flight hours	179	404	636	717	--	--	--	--	--	--	--	--	--	--	--	--	--	--	1,936
Crew per diem days	36	36	58	57	--	--	--	--	--	--	--	--	--	--	--	--	--	--	187
EATS (basic)																			
(Same as Option I)																			
<b>Option V--ARIA/SMILS</b>																			
707 ARIA/SMILS																			
Missions	95	61	58	60	47	70	69	79	61	53	51	42	50	50	49	51	46	38	1,030
Flight hours	1242.0	1344.0	1542.0	1422.0	1094.0	2096.0	1931.5	2377.5	1799.5	1683.5	1657.5	1338.0	1587.0	1652.0	1547.5	1652.0	1461.0	1229.0	28,588.0
Crew per diem days	411	347	348	341	311	440	436	461	351	327	321	278	314	321	306	325	293	262	6,193
P-3 SMILS																			
Missions	8	15	19	22	--	--	--	--	--	--	--	--	--	--	--	--	--	--	64
Flight hours	179	404	636	717	--	--	--	--	--	--	--	--	--	--	--	--	--	--	1,936
Crew per diem days	36	36	58	57	--	--	--	--	--	--	--	--	--	--	--	--	--	--	187
EATS (basic)																			
(Same as Option I)																			

UNCLASSIFIED

130

UNCLASSIFIED

UNCLASSIFIED

131

Table 33 (Concluded)

Option	1982	1983	1984	1985	1986	1987	1988	1989	1990	1991	1992	1993	1994	1995	1996	1997	1998	1999	Total
<u>Option VI (URIA)</u>																			
707 URIA																			
Missions	95	61	92	101	70	94	88	95	81	78	80	76	79	80	79	76	77	72	1,474
Flight hours	1242.0	1344.0	1966.0	1955.0	1495.0	2439.5	2378.5	2682.5	2254.5	2201.0	2282.0	2130.0	2270.5	2262.0	2230.5	2150.0	2185.0	2021.0	37,489.0
Crew per diem days	411	347	416	423	324	434	420	459	368	359	368	349	366	368	363	352	355	333	6,815
P-3 SMILS (Same as Option IV)																			
EATS (basic)																			
Missions	--	52	6	10	--	--	--	--	--	--	--	--	--	--	--	--	--	--	68
Flight hours	--	398	246	336	--	--	--	--	--	--	--	--	--	--	--	--	--	--	980
Crew per diem days	--	3	3	6	--	--	--	--	--	--	--	--	--	--	--	--	--	--	12
<u>Option VII-ARIA/SMILS, EATS(U) SMILS</u>																			
707 ARIA/SMILS																			
Missions	95	61	58	60	27	34	31	37	27	23	27	28	24	30	27	21	26	24	660
Flight hours	1242.0	1344.0	1524.0	1422.0	457.5	788.0	713.5	932.5	680.5	570.5	693.5	709.0	650.0	750.0	674.5	525.5	671.0	600.0	14,948.0
Crew per diem days	411	347	348	341	189	228	218	259	191	175	185	196	182	203	192	167	189	180	4,201
P-3 SMILS																			
Missions	8	15	19	22	--	--	--	--	--	--	--	--	--	--	--	--	--	--	64
Flight hours	179	404	636	717	--	--	--	--	--	--	--	--	--	--	--	--	--	--	1,936
Crew per diem days	36	36	58	57	--	--	--	--	--	--	--	--	--	--	--	--	--	--	187
EATS(U)																			
Missions	--	52	53	51	45	58	57	58	54	55	53	48	55	50	52	55	51	48	895
Flight hours	--	398	481	541	763	1366	1317	1449	1236	1366	1225	1060	1357	1132	1223	1347	1182	1060	18,503
Crew per diem days	--	3	3	6	53	128	109	120	84	111	81	52	111	64	80	109	73	52	1,239

UNCLASSIFIED

UNCLASSIFIED

# UNCLASSIFIED

(U)

phasing an option's required nonrecurring costs over the period of investment and calculating recurring costs from the annual workloads in Table 3I and 32 and the factors in Table 35 provides total LCCs.

(U) Summary LCC data for each option are presented in Table 36. Also shown is the fiscal year in which the resultant savings in O&S costs pay for the initial additional investment over baseline that is incurred by the option. When combined with an understanding of how the data were developed, Table 36 suggests the following:

- (U) Options III, IV, and VII are the most cost effective of the seven options.
- (U) The LCCs for Options III, IV, and VII differ by so little that, given the probability of cost estimating error, they should be considered equal.
- (U) Option V involves the least economic risk; the required additional investment is very low, involves minimal technical risk (for SMILS), and is amortized in one year.
- (U) Options III, IV, and VII have the lowest LCCs because they are less expensive with respect to the critical determinants of LCCs: initial investment, fleet size, and flying hour costs.
- (U) APATS pays for itself; in Options II and IV, the initial investment is amortized in nine years.
- (U) Combining all support requirements on one airframe (URIA) minimizes the fleet size and reduces support costs, but requires an initial investment that is 30% higher than the most cost-effective options, and employs an airframe (707) that is more expensive to operate than the P-3, whose function it replaces.
- (U) Discounting theory is basically to buy whatever is cheapest, when the choices occur at the same point in time, or to buy it later, if available at the same cost and have choices about when to buy it. For this analysis, the first of these two cases has the greatest influence; therefore, Option V looks relatively better because of the very low added investment and the minimal influence of O&S cost differentials between options over time. Options III, IV, V, and VII are essentially equal, their total LCCs falling within 4% of one another.

# UNCLASSIFIED

# UNCLASSIFIED

## d. Sensitivity Analyses (U)

(U) Uncertainties in the cost estimates and the assumptions associated with these estimates need to be tested to discern whether changes in them would affect the economic conclusions. The critical determinants of cost are:

- (U) Initial investment estimates for the higher risk developments. Estimates of the investment required for programs involving high technical risk, such as APATS, EATS, and EATS(U) could be too low by as much as 50% or more.\*
- (U) Differences in manpower ratios used to determine fixed annual support costs between the P-3 and an ARIA 707. In Options III and VII the P-3 would acquire a worldwide responsibility for some or all of the ballistic missile support functions now supported by the ARIA fleet. If personnel costs for the PMTC P-3 fleet were to be based on a ratio of officer, enlisted, and civilian personnel equal to that used by the 4950th TW (7%, 68%, and 25%, respectively), the per-aircraft fixed costs would increase by approximately \$250K per year.
- (U) Fuel costs per flying hour. The cost per flying hour would only affect LCCs if there were a severe increase in the fuel costs. If that occurred, options which employ a P-3 (which uses less fuel per hour) in a major support role should appear relatively more cost-effective than those emphasizing 707s.
- (U) Workload. Increasing the workload should only accentuate the effect of fuel cost increases. Workloads, however, could as well decrease from these forecasts.

(U) The options with lowest LCCs (III, IV, V, and VII) were tested for sensitivity to errors in the cost estimates and assumptions as follows:

- (U) Test 1--Increase investment estimates for development of APATS, EATS, and EATS(U) by 50%.
- (U) Test 2--Add \$250K per P-3 EATS(U) per year to account for a possible increase in the ratio of civilian technicians to enlisted personnel.

---

\* (U) Historically, R&D development program cost estimates are rarely too high.

Mr

# UNCLASSIFIED

(U)

- (U) Test 3--Increase the total flying hours for the ARIA and P-3 EATS(U) by 40% and determine the new flying-hour costs.
- (U) Test 4--Increase POL costs by 50% (see Table 37 for new flying-hour factors) and apply the increased dollars per flying hour to the (a) original workload and (b) the 40% higher workload under Test 3.
- (U) Test 5--Determine the cumulative effort on LCCs if all the above errors occurred as indicated (higher investment costs, added fixed costs, higher POL costs, and increased flying hours).

(U) Table 38 presents the results of these five tests along with the original LCCs and cost rankings (R) for the four options included in the sensitivity analysis. Then the table shows the additional dollars ( $\Delta$ \$), the percentage change (%) from the original LCC, and new total LCCs for each of the four individual sensitivity tests. For Test 5, the revised cost rankings are also provided.

(U) As expected, Test 1, which increased the investment costs associated with higher risk development items, caused a higher percentage change in the options with more phased-array antenna systems (Options III and IV have seven and eight antenna systems, respectively) than those with fewer (Options V and VII each have four systems). Changing the ratio of civilian technicians to enlisted personnel for P-3 EATS(U) support (Test 2) had a negligible effect on Options III and VII, and none on IV and V. Increased flying-hour estimates and flying-hour costs (Tests 3 and 4) resulted in a higher percentage change in the LCCs of those options dominated by ARIAs (Options IV and V) than in those dominated by P-3s (Options III and VIII). Adding the cumulative effects of these tests (Test 5) increased the LCC for Option III the least, and for Option IV the most.

(U) Although the five sensitivity tests caused the relative ranking of the LCCs of Options III, IV, and VII to change, the original economic conclusions are insensitive to such errors or assumption changes as were tested; that is, all LCCs remain within 10% of each other. The sensitivity analysis results do indicate, however, that as the changes

# UNCLASSIFIED

(U)

accumulate (Test 5), Options III and VII which emphasize use of P-3 assets) improve their relative cost effectiveness.

5. Conclusions and Recommendations (U)

a. Conclusions (U)

(U) All seven options were capable of performing the future mobile aircraft support requirements. Three of those options (III, IV, and VII) have distinct life-cycle cost advantages over the remaining options. To make recommendations, SRI made technical and operational comparisons of these three options, which are summarized in Table 39. The cost of each option (summarized first in Table 36) is in terms of the initial nonrecurring cost, and the total LCC. These LCCs are within a few percentage points of each other.

(U) The aircraft fleet sizes reduce the baseline needs from 17 aircraft to 10 aircraft with Options IV and VII or to 11 aircraft with Option III.

(U) Technically, all three options are virtually the same, since they employ a multibeam phased-array telemetry antenna. The analyses have shown this antenna to be a cost-effective investment, due to the reductions in the aircraft fleet and in the number aircraft missions necessary to support multiple-IRV tests. In addition to economic advantage, either the EATS(U) or the APATS antenna offers improved telemetry data quality due to a higher gain (8 dB G/T versus 3 dB G/T) than the existing ARIA dish antenna.

(U) The growth potential of Option III, which uses the EATS(U)/SMILS aircraft exclusively for ballistic missile program support, is virtually nil, since the P-3B aircraft would be operating at its upper design limit for payload, and little fuselage volume would remain for future instrumentation additions. Because Options IV and VII employ a 707-320C aircraft, they have the growth capability of the "stretched" 707 fuselage. The 707-320C will also permit the addition of an aft fuel tank for longer endurance if necessary for future missions.



Table 39

## (U) URIA OPTION COMPARISONS AND RANKING

Parameter	Option III EATS(U)/SMILS	Option IV 707 ARIA/APATS/SMILS	Option VII EATS(U)/SMILS & 707 ARIA/SMILS
Cost (1980 \$M)			
Initial investment			
Total LCC			
Fleet size (aircraft)	11	10	10
Technical and operational factors			
TM capability	EATS(U) phased array	APATS	EATS(U) phased array, plus ARIA dish
Growth	None: P-3 volume and weight at limit	Good: Additional 707 volume and weight available	Good with 707; none with P-3
Organization	Transfer all ICBM/SLBM workload to new organization	Retains ICBM/SLBM at experienced organization	Uses both 4950th TW and PMTC
Technical risk	Moderate: New phased array	Moderate: New phased array	Moderate: New phased array
Operational risk	Moderate: New organization	Low: Old organization	Low: Old organization
Ranking	Not preferred	Preferred	Preferred

UNCLASSIFIED

140

UNCLASSIFIED

UNCLASSIFIED

# UNCLASSIFIED

(U) Organizational factors were evaluated because both Options III and VII involved a major change in the organization that has historically provided this support: the 4950th TW at WPAFB. In Option III, the EATS(U)/SMILS P-3 aircraft would be operated exclusively out of PMTC at Pt. Mugu, California. This change in organizational responsibility could involve unidentified costs for the additional personnel and facilities required at PMTC for the maintenance and operation of seven aircraft, as well as for training and experience.

(U) In Option VII, the shift in organizational experience is only partial, since the 4950th TW at WPAFB would continue the ARIA/SMILS and a large portion of the ICBM/SLBM support role, with the EATS(U)/SMILS at PMTC providing BOA support only for multiple-IRV missions.

(U) The operational risk, which is directly related to the operational factors, is moderate for Option III, since the entire ballistic missile support is transferred to a new organization. Options IV and VII entail low operational risk, since the 4950th TW experience and facilities are present in both.

(U) Technical risk for all three options is moderate, since all involve new airborne phased-array telemetry antennas. In the final rankings, Options IV and VII are equally preferable; Option III is the least preferred.

(U) Economically, Option VII (EATS(U)/SMILS + ARIA/SMILS) has the advantage over Option IV (ARIA/APATS/SMILS) of a lower nonrecurring investment. A disadvantage of Option VII is that there is no payload growth potential on P-3 aircraft resources with a phased array.\* Option IV offers the least operational risk, since the ballistic missile support is retained at 4950th TW and the 707 ARIA provides payload growth potential on all ballistic missile aircraft resources. Both options amortize their development costs in 2 to 4 years after attaining full operational capability (FOC).

---

\* (U) As mentioned earlier, the inclusion of the GPS-SMILS on the P-3B will require an additional 2000 lb.

# UNCLASSIFIED

## b. Recommendations (U)

(U) The study does not clearly identify a preferred option, but rather supports a recommendation for an aircraft resource evolution strategy that could offer advantages. This recommended strategy is to start development on both Options IV (ARIA/APATS/SMILS) and VII (EATS(U)/SMILS + ARIA/SMILS) since the early phases of both are on a common path, except for the designs of the EATS(U) and the APATS telemetry antennas. The acquisition and exchanging of 707-320Cs for the six EC-135Ns, the addition of SMILS to ARIA, and the continuance of the EATS prototype are common to both options. This approach provides the nation with a minimum-risk program because it permits a management decision point early in the development of both options to review the risk and performance factors of the APATS and EATS(U) phased-array antenna development efforts, and to select the most successful, with a minimum loss of parallel development funds. Also, significant economic or technical advantages could develop during the design phases.

(U) The recommended strategy toward achieving Option IV or VII is as follows:

- (1) (U) Develop Pacific P-3 SMILS; its interim support is needed for either option.
- (2) (U) Proceed with 707-320C baseline upgrade.
- (3) (U) Develop SMILS on ARIA, since it is on the path to either Option IV or VII.
- (4) (U) Continue APATS design phase (\$3.6M) and EATS(U) telemetry design (\$3.1M) and review both programs by the end of FY82.
- (5) (U) Develop either EATS(U)/SMILS or ARIA/APATS/SMILS.

(U) This strategy minimizes risks, since hedge options are offered at a minimum cost of insurance. All major phases of the evolution sequence are on a common path to either preferred option, thus conserving both time and money. The implementation schedule for these dual program elements, the agency responsibilities, and the budgetary flows are presented below.

# UNCLASSIFIED

## c. Implementation Plan (U)

(U) Figure 22 is a schedule for a sequence of events supporting the development strategy. This plan identifies each organization involved, their required action(s), and, where appropriate, the aircraft resources involved. The schedules of aircraft resource modification were consolidated from separate preliminary schedules (from 4950th TW for ARIA assets, and from PMTC on Pacific SMILS) and assume an accelerated EATS program. Ratification and refinement of the final schedule can be accomplished on a go-ahead decision from OUSDRE.

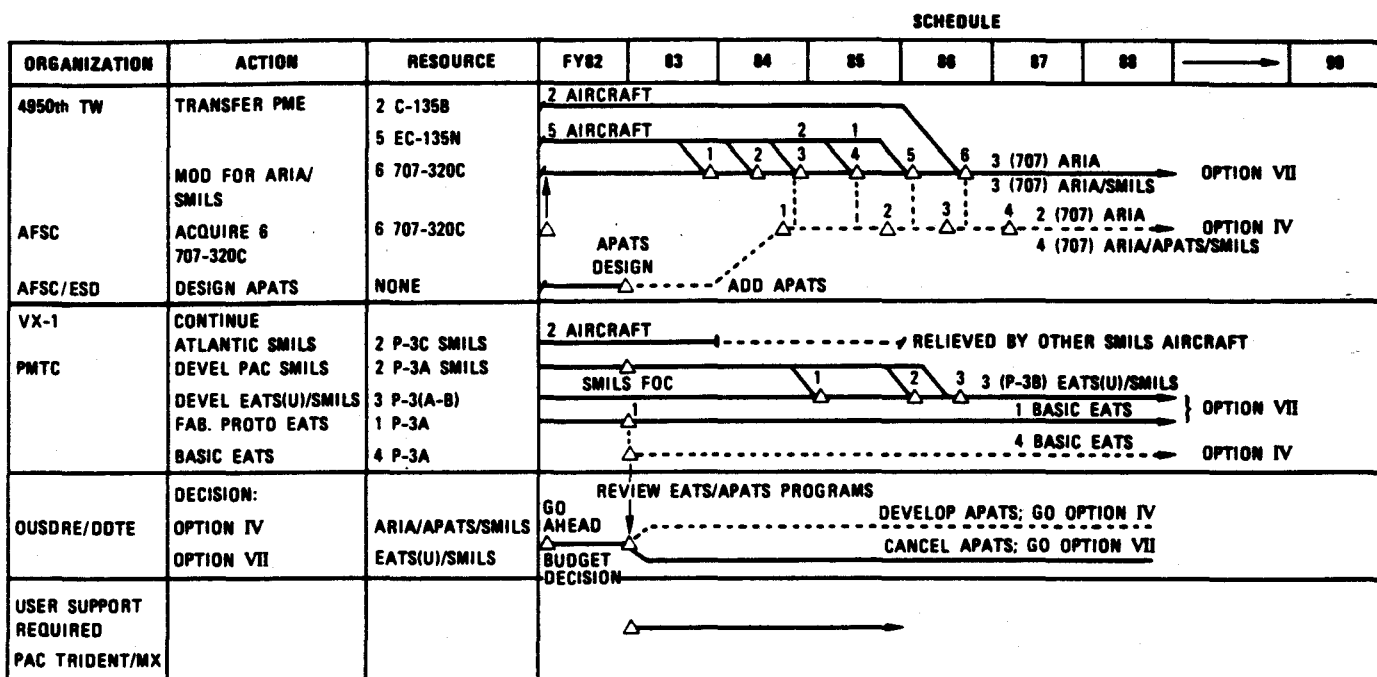

UNCLASSIFIED

FIGURE 22 (U) AIRCRAFT RESOURCE DEVELOPMENT PLAN

(U) The resource evolution plan shows two alternative paths to either Option IV (ARIA/APATS/SMILS) or Option VII (EATS(U)/SMILS + ARIA/SMILS) pending a OUSDRE decision in early FY83 on the success and status of the EATS and APATS programs. A favorable EATS review would permit continuing with Option VII (solid lines) and cancelling further APATS development. Alternatively, a more favorable APATS program progress offers a switch to Option IV (along dotted line) where APATS is continued, and EATS(U)/SMILS efforts revert back to the standard EATS program.

# UNCLASSIFIED

(U) User-critical dates and continued support are maintained in either case, since interim Pacific SMILS is operational, and since either baseline ARIA or an upgraded ARIA/SMILS resource is available. Careful scheduling will be required, however, by 4950th TW to ensure that sufficient aircraft resources are available during the modification of 707-320Cs to ARIA.

d. Budgetary Cost Streams (U)

(U) Tables 40 and 41 show the annual budget required to achieve either Option VII or IV and identify the investments necessary for individual items and the agency responsible for the item's development and acquisition.

Ex 5

UNCLASSIFIED

e. Remaining Issues and Considerations (U)

(U) As with many studies, initial conditions and assumptions change during the study. Additional issues and impacts that evolve must also be considered, even though time and resources precluded them from analysis, as they may affect the study conclusions. Additional considerations that were not analyzed directly are:

- (U) Item 1--Loss of an EC-135N on 6 May 1981.
- (U) Item 2--Congressional appropriation approval for the Air Force to buy 707-320Cs.
- (U) Item 3--Questioning of the need for 5 beams and dual-faced telemetry array on the EATS AIS.
- (U) Item 4--The certainty of fleet exercises and tactical missile T&E workload at PMTC.

(U) Item 1 notes the loss of one of the six EC-135N ARIA, reducing the fleet from 8 to 7 (there are also two EC-135B ARIA). Although this regrettable loss occurred late in the URIA study, it does not impact the study results, as only six ARIA are required in any of the recommended options. There may be an impact in the reduction of 4950th's resources on maintaining the near-term workload. This aspect has not been considered in this study.

# UNCLASSIFIED

(U) Item 2 notes the congressional approval for the Air Force to buy 707-320Cs. This event did not influence the recommendation for alternative aircraft for the EC-135N replacement, as there are undoubtedly many other organizations within the Air Force who require replacement aircraft.

(U) Regarding Items 3 and 4, the basic EATS requirements were addressed in conversations between OUSDRE/DDTE and PMTC. These conversations queried the potential of using two or three single-faced, 4-beamed APATS-equipped 707-320C ARIA (with EATS multilateration and data relay subsystems) instead of the EATS P-3 AIS. Preliminary indications by PMTC suggest that this may be acceptable, since the higher flying capabilities of the 707-type aircraft could maintain line-of-sight contact with EATS land stations by circularly orbiting the test arena, thereby relieving the race-track stationkeeping currently required by the altitude-limited P-3 aircraft, and consequently the need for a dual-faced antenna.

(U) Other impacts of using a single-faced APATS ARIA for EATS AIS role which must be considered are:

- (U) Impact on EATS multilateration tracking accuracy by orbiting via stationkeeping AISs.
- (U) Reduction of number of simultaneous telemetry objects from 10 to 8 (two EATS versus two APATS antennas).
- (U) Operational cost impact of using 4950th-based ARIA to support PMTC/EATS workload.
- (U) Defining firm EATS AIS workload estimate, particularly if higher aircraft support costs are considered.
- (U) Additional APATS ARIA (and 707-320C or EC-135Bs) to accommodate the revised EATS AIS role and workload by 4950th TW.

(U) Pending the resolution and acceptability of the above considerations, a new option can be defined, a blend of Option IV (ARIA/APATS/SMILS) and Option VI (mixed-PMEE URIA). The impact of this new potential option (if further analyses prove it viable) on the study recommendations would be to augment the ARIA assets in Option IV with any additional APATS aircraft resources required and the elimination or reduction in

# UNCLASSIFIED

# UNCLASSIFIED

(U)

the AIS portion of PMTC's EATS program. The investment funds should be between Option IV-4 and Option VIb. If the projected EATS AIS workload is also found to be smaller, the O&S cost would be less than for Option VI. 15

(U) As this report was going into publication, OUSDRE/DDTE directed that an additional URIA option be analyzed by the SSTSS Working Group. The structure and results of this additional option (Option VIII) are being documented by the URIA subgroup in a supplemental SSTSS report (currently in production).

## E. Advanced Range Instrumentation Ships (U)

(U) The Advanced Range Instrumentation Ships (ARIS) are seaborne mobile platforms whose primary mission is to collect data during satellite orbit insertions and during the midcourse and reentry phases of ballistic missile flight. To this end, ARIS instrumentation is designed to collect radar signature, telemetry, and metric measurement data on satellite and missile systems. Two ships comprise the ARIS fleet: the USNS General H. H. Arnold and the USNS General Hoyt S. Vandenberg, both converted C-4 class troop ships. The ARIS instrumentation suite includes multiple high-performance radars, broadband telemetry systems, and extensive optical measurement equipment. Associated data handling, navigation, timing, communication, meteorology, and marine support systems allow independent operations worldwide. Other ship resources (the USNS Redstone and Range Sentinel) are principally launch area or downrange support ships (LASS and DRSS) and were not an issue for the SSTSS.

### 1. ARIS Capabilities (U)

(U) Instrumentation on the ARIS is designed and optimized to gather data which will lead to a more thorough understanding of the reentry portions of ballistic missile flight. In particular, the ARIS instrumentation is designed to measure phenomena associated with RV



# UNCLASSIFIED

(U)

interaction with the atmosphere. Specific interest lies with those RV characteristics that produce distinct radar or optical signatures, modulations, and emissions during reentry.

(U) Figure 23 shows the inboard ARIS profile and basic instrumentation. Figure 24 is an aerial view of the USNS Vandenberg; the external portions of the radar, telemetry, optic, and communications systems are visible. The prime instrumentation systems aboard the ARIS are:

- (U) Operations control center
- (U) Radar systems
- (U) Telemetry systems
- (U) Optical systems
- (U) Navigation/stabilization systems
- (U) Data handling system
- (U) Timing systems
- (U) Meteorology systems
- (U) Communications systems.

(U) The central item of the operations control center is the designate control console. From this console, mission operations are directed, and all pertinent instrumentation equipment is monitored. This console permits selection and direction of systems that must be slaved to other sources of pointing data and continuously monitors the performance of the ship's radars. A mission countdown clock is included in the control console, providing mission count or hold status to all mission instrumentation equipment. The control center maintains access with range communications networks for realtime coordination in mission development and status.

(U) The prime capability of the ARIS resides in onboard instrumentation radars. Three radars are available, two sharing a common 40-ft parabolic antenna: C-band, L-band, and UHF-band radars. The primary tracking radar is a 5500 MHz, dual-polarization, pulse compression system with several unique features. This radar has dual transmitters, allowing interlaced polarization transmissions (vertical and

# UNCLASSIFIED

UNCLASSIFIED

151

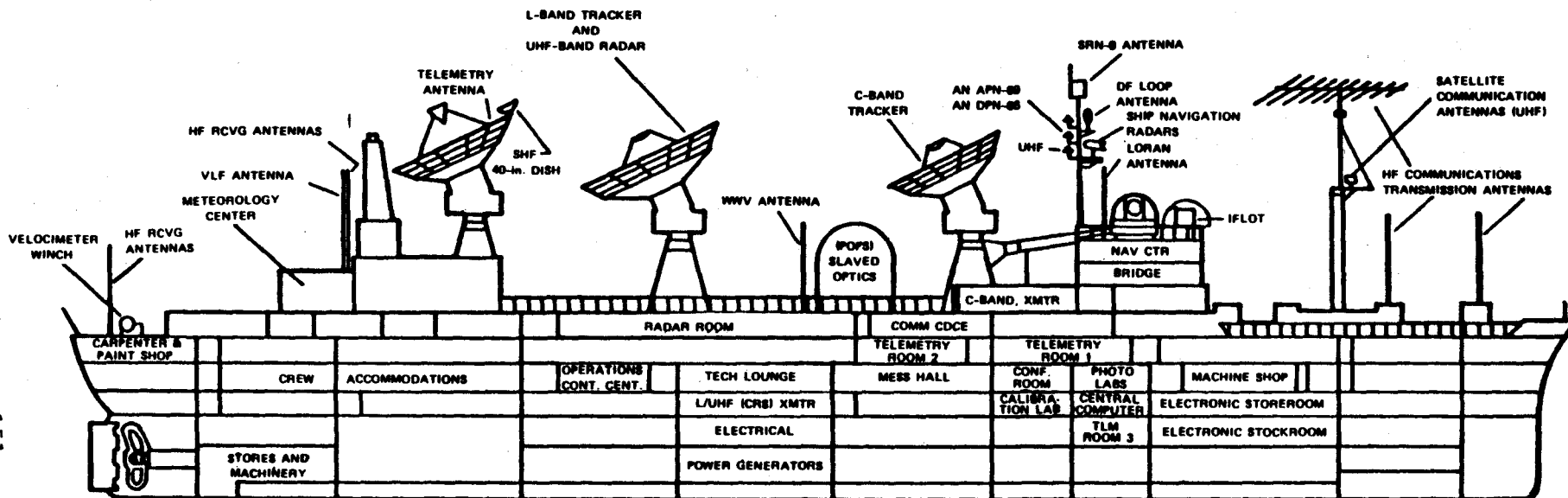

UNCLASSIFIED

TYPE:	CONVERTED C4-B-A1 TROOPSHIP
LENGTH:	522 ft
BEAM:	72 ft
DRAFT:	26 ft, 3 in.
DISPLACEMENT	
FULL LOAD:	17,120 tons
LIGHT SHIP:	13,170 tons
SUSTAINED SEA SPEED:	15 knots (non-tracking)
FUEL OIL CAPACITY:	EXCESS OF 2500 tons
CERTIFIED:	HIGHEST CLASS ABS
WORK AND LIVING AREAS:	FULLY AIR CONDITIONED

UNCLASSIFIED

FIGURE 23 (U) ARIS INBOARD PROFILE

UNCLASSIFIED

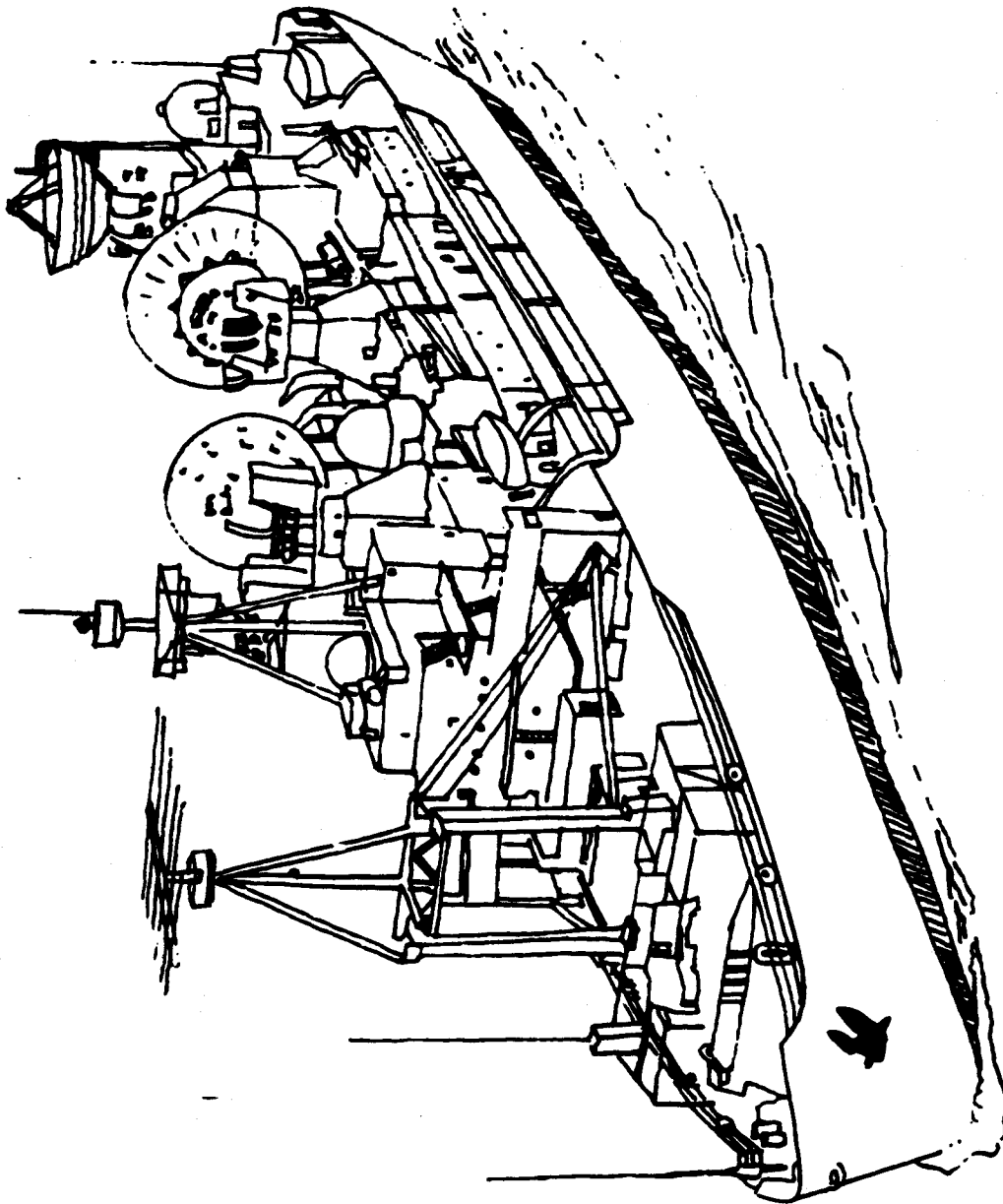

FIGURE 24 (U) USNS GENERAL HOYT S. VANDENBERG

UNCLASSIFIED

UNCLASSIFIED

# UNCLASSIFIED

(U)

horizontal), with pulse compression (linear FM, i.e., "chirp") incorporated in both systems. Both skin and beacon tracks are available from this radar. Precise angle tracking is provided when "skin-tracking" with a 4-horn monopulse system working together with a pulse compression ratio of 50:1 (30  $\mu$ s pulse; linear FM over 3 MHz; compressed to 0.6  $\mu$ s); cross-polarized target return data are also available by the use of the two transmitter/receiver systems. X  
rel

(U) The L-band and UHF radars share a common 40-ft parabolic antenna, but are separate radar systems. The L-band radar (1280 MHz) is a horizontally polarized monopulse radar with an 80 MW peak power output, 30  $\mu$ s transmitted pulse (50:1 compression) with a pulse repetition frequency (PRF) identical to the C-band radar (160 pps). X  
rel

(U) The 435 MHz UHF radar has a coherent transmitter and uses vertical polarization and either 30- or 300- $\mu$ s "chirped" transmitter pulses (3 MHz FM for both pulse widths). The PRF is primarily 160 pps. However, other PRFs can be selected from 960 to 1600 pps in multiples of 160 pps. The transmitter is comprised of 24 traveling-wave tubes (TWTs); combined outputs provide 5.6 MW peak power. Linear FM on either pulse width ("chirp") is constrained to 3 MHz, even though the transmitter is capable of 30 MHz or more FM. The UHF radar utilizes the antenna tracking circuits of the L-band system. Thus, these two cover the same volume. Separate circuits allow the range tracking of individual targets within the range limits. Also, the UHF radar provides phase and amplitude data on extended target returns (e.g., chaff or plasma returns) within the tracking volume. rel X

(U) Use of all three radars with the variety of transmitted and receiver polarizations provides a three-frequency set of target signature characteristics. All radar data are available on high-quality recordings and may be analyzed during postmission data reduction.

(U) There are two telemetry systems aboard the USNS Vandenberg, a 30-ft autotrack system and an additional 17-ft autotrack system that can provide telemetry tracking for a second incoming RV. The 30-ft

# UNCLASSIFIED

(U)

system (ASPS), an electromagnetic log, LORAN C, Decca HI-FIX, and a satellite navigation receiver. Outputs from the SINS provide stabilization for the various sensor pedestals (optic, radar, etc.). For precision navigation, the SINS data are used for interpolating ARIS position between satellite-derived or ASPS position fixes.

(U) Data from the telemetry and radar sensors must be suitably processed prior to retransmission or recording. This data-handling subsystem performs the following functions:

- (U) Conversion of data formats and records metric and signature data from the radars and navigation equipment.
- (U) Interfacing between sensors for target designation, navigation, calibration, and checkout.
- (U) Generation of target-designated data suitable for retransmission to other platforms requiring target coordinates.

This data-handling subsystem is made up of three major equipment groups: (1) data processing equipment, (2) video recording equipment, and (3) data conversion equipment.

(U) ARIS timing is derived from a cesium time standard that is correlated with WWV or WWVH time transmissions. Correlation of ship time with a master-time reference can be accomplished to within 100  $\mu$ s. Multiple outputs and formats from the timing subsystem are produced in standard IRIG format.

(U) Meteorological conditions are sometimes required in the impact area for ballistic missile reentry tests. These data are gathered for both surface and aloft conditions (10 to 100,000 ft) and sent to Patrick AFB by teletype. Surface weather data are obtained from wind measuring sets, aneroid barometers, portable psychrometers, and microbarographs. Similar data on upper atmospheric conditions are received from balloon-borne sensors. Wind velocity and direction, humidity, temperature, and atmospheric pressure are gathered and processed for both surface and upper atmospheric (in addition to sea-state) conditions at the impact area.

# UNCLASSIFIED

# UNCLASSIFIED

(U) The ARIS can be used as the scoring transducer and recorder platform over the DOT array, as well as the vehicle for array installation and maintenance. Most of the present BOA RV impact scoring is done using the P-3 SMILS surface sonobuoy pattern, which locates itself with respect to the DOT array.

(U) Crew size of the two ARIS is about 165. Quarters are provided for 90 officers and marine crew on both the Vandenberg and the Arnold. Technical crew quarters can accommodate 109 on the Vandenberg and 119 on the Arnold. The usual technical crew complement is about 55 for the Vandenberg and 65 to 70 for the Arnold. Technical crew complements will vary with the particular mission, this is especially true for certain Arnold missions.

## 2. ARIS Deficiencies and Improvements (U)

(U) In spite of the many instrumentation advantages of a terminal area support ship (TASS) as a mobile support platform in the BOA (signature data, time on station, multiple, varied sensors), some disadvantages must be considered. Among these are (1) the ship speed (about 13 knots) that limits the response time of a TASS to accommodate changing test schedules, (2) the large crew necessary for both marine and technical requirements, and (3) the necessity for the ship to refuel at foreign ports on extended deployments, etc. Another disadvantage for both the USNS Arnold and the USNS Vandenberg is that these ships will be taken out of service in a few years for the ship life extension program (SLEP), an extended period of shipyard work to extend the life of the vessel and the sensor suite aboard. The SLEP might require that two ships be maintained in the Fleet; one TASS would cover test missions, while the other is in the SLEP period. If only one TASS is kept in active status, \*

---

\* (U) The USNS Arnold is scheduled for retirement in the early 1980s.

# UNCLASSIFIED

(U)

the SLEP will require the test community to schedule around the shipyard period and/or to use some other vessel for DOT maintenance, signature/metric requirements of the A3TK, and so forth.

(U) Another program being considered is the replacement of the Arnold and Vandenberg with vessels having smaller, and thus more fuel-efficient, hulls. The two present ARIS have C-4 hulls. A proposal has been made to use available C-3 hulls and to move the sensor systems from the Arnold and Vandenberg to the C-3 hull. During this conversion period, the test community would also have to schedule around the extended period that the ARIS was off-line.

(U) A basic limitation of the ARIS is the accuracy with which the ship can locate and orient itself with respect to the geodetic coordinate system for test support. This ability becomes important where radar metric data are required for RV reentry tracking in geodetic coordinates. The radars themselves can track with comparatively good precision (about 0.25 mrad) relative to the ship, but geodetic accuracy of this data is a function of knowing the ship's position and heading to comparable accuracies. Although the SINS provides the ARIS with good position and heading data immediately after calibration, it is prone to substantial drift within a few days. In practice, radar metric data from the ARIS's instrumentation are used in posttest best estimates of trajectory (BET), with the ship's absolute position handled as a floating point (no pun intended) in the calculations. This, in effect, locates the ship relative to the BET after the test data are processed.

### 3. Future Ship Workload Projections (U)

#### a. Ship Operational Scenarios (U)

(U) Discussions with the cognizant organizations at the Eastern Space and Missile Center (ESMC) have shown that for a given year (365 days), the ARIS spends an average of 60 days in a shipyard and 35 days engaged in various logistics activities. This leaves a total of 270

*159 deleted*

deny the use of airbase facilities in South Africa for the P-3 and ARIA instrumentation aircraft. Therefore, if this situation persists, an ARIS is required to perform the scoring and telemetry collection roles.\* This scenario (shown in Table 42) was provided by ESMC. This scenario does not show the six days required for ship refueling or crew shore-leave.

b. Baseline Ship Workloads (U)

(U) Workloads for the ARIS have been derived for the baseline case. These workloads were developed from the ship support missions and their locations (Table 43). The projected and total annual ship workloads (in ship-days) are tabulated in Table 44 for FY82 through FY90. More missile testing is anticipated to occur in the latter part of this decade and on into the 1990s, but firm missile launch schedules and ARIS use commitments are not available and are not provided in the schedule.

(C) In FY82 several missile launches and special missions (including perhaps the Space Shuttle) will require the ARIS in the Atlantic Ocean (perhaps also in the Indian and Pacific Oceans).

*spying on SSS  
Tests? 11/2 A  
at Su.*

Transit between Port Canaveral and Honolulu (the Pacific staging base) requires a transit of the Panama Canal and takes 20 days each way.

(U) Days required to install the particular Pacific scoring array are measured from Honolulu to the site and back. A single DOT array

\* (U) Recently, during the writing of this report, the ARIA was cleared to stage out of Cape Town, South Africa.



# UNCLASSIFIED

Table 42

(U) TRIDENT (C-4) SCENARIO FOR ATLANTIC TASS AT C18

Event	Time Requirement
1. Transit from Port Canaveral, Florida to Recife, Brazil	$\frac{3,433 \text{ nmi}}{324 \text{ nmi/day}} = 11 \text{ days}$
2. Recife to TSP (C18)	$\frac{3,318 + 300 \text{ nmi}}{324 \text{ nmi/day}} = 12 \text{ days}$
3. Days on TSP (C18)	7 days
4. TSP to Ascension	$\frac{2,409 + 300 \text{ nmi}}{324 \text{ nmi/day}} = 9 \text{ days}$
5. Ascension to Recife	$\frac{1,226 \text{ nmi}}{324 \text{ nmi/day}} = 4 \text{ days}$
6. Recife to Port Canaveral, Florida	$\frac{3,433 \text{ nmi}}{324 \text{ nmi/day}} = 11 \text{ days}$
	Total 54 days

324 nmi/day.  
1.9 km/  
nmi.

Note: Does not include layover days at either Recife or Ascension; a total of 6 days.

UNCLASSIFIED

from vol II.

# UNCLASSIFIED

(U)

takes the ARIS 14 days to install and survey. A double-DOT array (such as launch points (LP) 11 and 12) takes 21 days to install. The two submarine launch points were originally given as requiring double DOTs, but prior to the finalization of this schedule, the Navy reduced the requirement to a single DOT array over the launch points. The total time for the ARIS to install the launch-point DOTs is 48 days, with a refueling stop in San Francisco between the two DOT installations.

(U) The single-DOT installations are at three impact scoring locations: about 80 nmi north of the Kwajalein Missile Range (MX tests), between Wake and Midway Islands, and near the island of Oeno in the South Pacific.

(U) The indicated workload for the ARIS includes a "special mission" and a scheduled mission for the Space Shuttle. The "special mission" will only be for FY82, since a new ship (Cobra Judy) will be coming on-line for future missions of this type. Also, any Shuttle flights requiring ship support are expected to be completed prior to the end of FY82.

(U) Starting in FY83, the scheduled ship workload begins to decrease as the identified number of missile programs needing terminal area ship support declines and the installation of the new DOT scoring arrays is completed. All remaining DOT array installations will be completed in FY83, and all are in the Pacific for both MX and TRIDENT tests. At present, two missile programs are scheduled for terminal area ship support in FY83: the TRIDENT (C-4) and the decoy program, MK-500. The C-4 program requires ship support at the C18 impact area, due to its remote location and lack of aircraft staging areas.

(U) MK-500 tests are targeted to the Ascension Island test area, but due to instrumentation requirements, both shipborne and land-based

# UNCLASSIFIED

# UNCLASSIFIED

(U)

assets are needed for all MK-500 tests. The time allocated for MK-500 tests--31 days--includes the minimum transit time between Port Canaveral and Ascension plus 5 days for the ARIS at the test position.

(U) Maintenance of the C18 Atlantic impact area has always been included with a support mission in which the major amount of time required is to reach the C18 area from Port Canaveral. The ship must include two refueling stops on this trip. These refueling stops are not charged to the mission, but to the 35 days set aside for logistics.

(U) Transit to the Pacific staging port requires 20 days, with scoring DOT array installation scheduled at BOA-1, BOA-2, and BOA-3. The exact location of the BOA-3 impact area is not yet firm. Therefore, some adjustments may have to be made to the DOT installation schedule to accommodate a change in location for the BOA-3 impact area.

(U) After FY83, the known requirements for the ARIS drop drastically. There are no (C-4) test requirements at the long-range C18 impact area. Only scoring array maintenance is indicated for the MX and TRIDENT programs.

The MK-500 has been previously mentioned with respect to the need for instrumentation augmentation for launches into the Ascension area.

Oeno = UK land terminal.

BOA 1, 2, Guam Atap, at Wake Is.

BOA 3 = Chatham Is, NZ.

at .  
324 nmi/day  
p. 161.  
= 6480 nmi.  
re mid Pacific.

X

X

3

# UNCLASSIFIED

## 4. Baseline ARIS Costs (U)

(U) The following paragraphs summarize the cost to the nation of operating and maintaining the ARIS ships (Vandenberg and Arnold) to support the baseline workload discussed above. The basic cost data, in constant 1980 dollars, are provided in Table 45. Cost categories include nonrecurring, fixed annual, and variable annual costs. Fixed annual costs are recurring costs of crew salaries and maintenance of an operationally ready resource, regardless of whether it is actually used. Variable annual costs are mission-related costs. Table 46 summarizes the per-mission variable costs for the two ARIS ships.

(U) Table 44 and 45 costs, when applied to baseline workload data, yield baseline life-cycle ship costs, as shown in Figure 25. This LCC curve assumes that nonrecurring and variable investments occur as follows:

- (U) SLEP-related costs occur equally over the period 1984-1992.
- (U) USNS Vandenberg SLEP design, instrumentation, and space-allocation improvements occur in 1982 and 1983.
- (U) USNS Arnold is prepared for storage at the end of 1983.
- (U) SADOT/DOT installation costs occur according to the DOT installation schedule.
- (U) Variable costs are applied according to the workload schedule.

## F. SSTSS Recommendation for Ship Alternatives (U)

(U) When the SSTSS was initiated, several matters involving the range instrumentation ship resources needed resolution. First, the DoD was concerned over the SLEP expenditure that would be required of the ARIS (the USNS Vandenberg). Also, the USNS Wheeling at PMTC (Port Hueneme) was down hard and had been budgeted for replacement (about \$60M in 1980\$). The USNS Arnold, a special mission ship, was being replaced by the USNS Observation Island, Cobra Judy, and DoD wished to retire the USNS Arnold if possible.

~~UNCLASSIFIED~~  
~~CONFIDENTIAL~~

(U)

*Release*  
does not require a large, fully instrumented ARIS. Third, after the peak workload in 1982-1983 requiring mobile instrumentation test support unique to the ARIS, the ARIS workload becomes quite low (50 to 75 days per year). This post-1983 ARIS workload is distributed between three programs:

- X
- (U) British A3TK
  - (U) Navy MK-500
  - (U) TRIDENT (D-5).

The A3TK program is not projected beyond 1990, and the need for ARIS support could be curtailed as early as 1983. The Air Force is currently investigating this possibility.

(U) The MK-500 program is not firmly scheduled with only occasional launches into Ascension that require ARIS support.

Moreover, the Navy has indicated that these long-range tests could be performed in the Pacific, if necessary, where aircraft staging areas abound.

2. Recommendations for Ship Resources (U)

(U) An early SSTSS recommendation to the MRTFC was to defer plans to replace the USNS Wheeling because ship workload projections were an insufficient basis for such replacement plans. The 1982 budget contained \$28M for that purpose. This recommendation was accepted by OUSDRE and the Navy.

(U) Next, alternative ship concepts for performing DOT installation and maintenance were considered. It was determined that either a NAVOCEANO or commercial vessel, suitably equipped with DOT acoustic surveying equipment,

*6*  
To  
provide a firm commitment for Pacific DOT installation to meet near-term

*from vol II*

~~UNCLASSIFIED~~  
~~CONFIDENTIAL~~

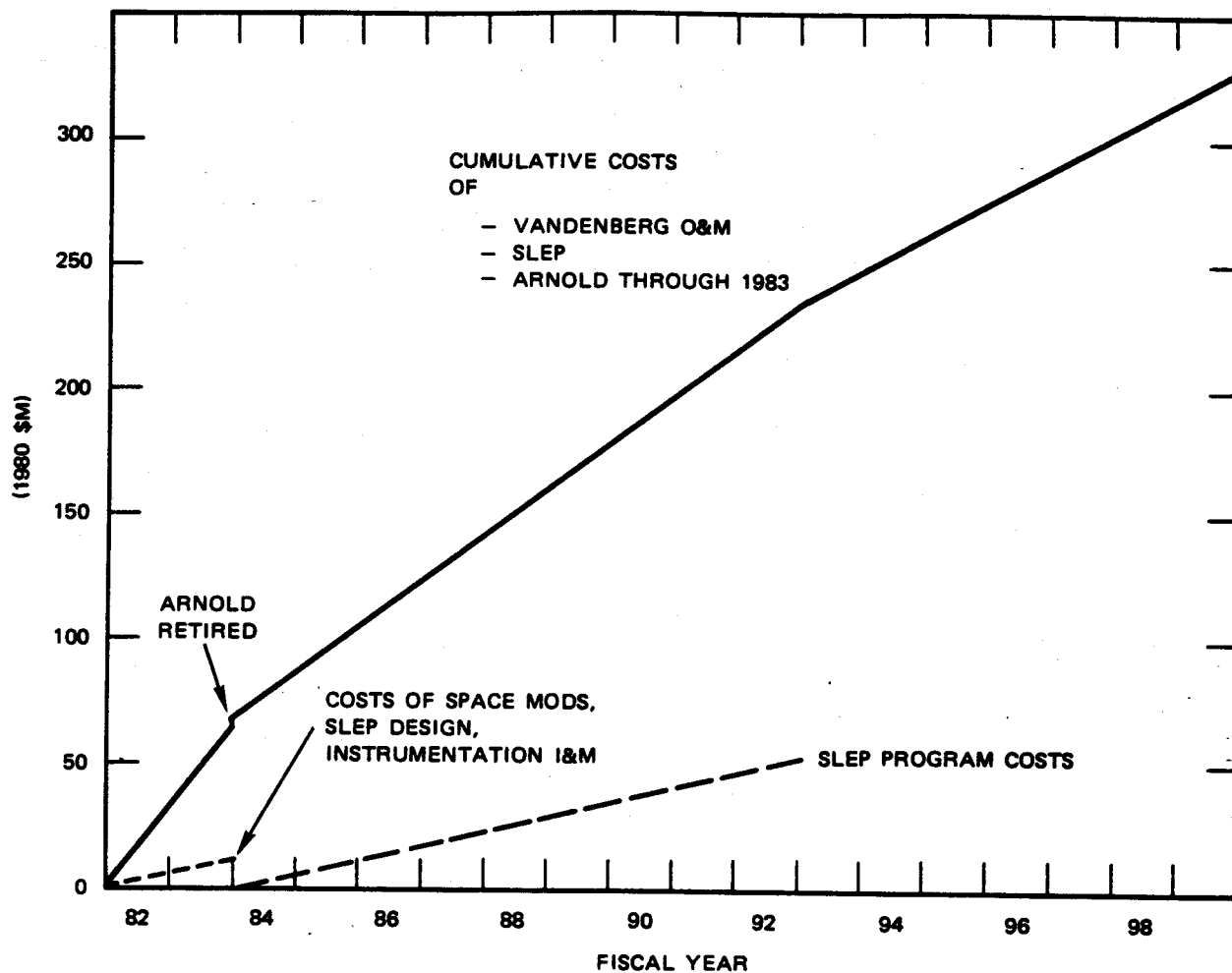

UNCLASSIFIED

FIGURE 25 (U) BASELINE SHIP LIFE-CYCLE COSTS (cumulative)

1. Review of Ship Support Needs (U)

(U) After considerable research and dialog with ESMC and the user community, the SSTSS Working Group developed a consolidated baseline workload projection for the ARIS, which was recently presented. These workloads (projected through 1999) offer several prospects for reducing the nation's cost for the resources. First, after a fairly heavy (about 400 ship days per year) commitment in 1982 and 1983, the workload falls below 270 days per year, which a well maintained ship can handle. Second, the bulk of this workload is for the installation of Pacific Ocean DOTs (1982-1983), and continuing DOT maintenance in both oceans

# UNCLASSIFIED

(U)

MX and TRIDENT needs, PMTC arranged with NAVOCEANO to perform the initial Pacific DOT installation. NAVOCEANO, however, did not agree to perform subsequent routine DOT maintenance. The SSTSS Working Group also identified potential commercial vessels that could do the maintenance if provided with the acoustic survey and navigation equipment that would be developed for NAVOCEANO's Silas Bent.

(U) One further cost-saving concept was studied: an oceangoing tug to install and maintain the DOT array at KMRN. This Kwajalein broad ocean area tug (K-BOAT) is described more fully later in this section. Costs for outfitting the K-BOAT with DOT installation equipment could be quickly amortized, whereas using the NAVOCEANO and commercial vessels stationed on the West Coast for this support would be more expensive.

(U) The plan and schedule for DOT installation, which have been developed using the NAVOCEANO and commercial ships, are summarized in Table 47.

be done by the Silas Bent from November 1981 through June 1982. Agencies responsible for this task are PMTC and NAVOCEANO.

(U) Once the USNS Silas Bent (NAVOCEANO) has finished, the DOT acoustic installation and navigation equipment will be transferred to a contract vessel during June 1982 through 1983 for installation of the MX DOTs at BOA-1, then BOA-3 and -2. This task will also be the responsibility of PMTC.

(U) The K-BOAT will install the MX DOTs at KMRN under the joint responsibility of the KMRD and WSMC in August 1982.

(U) Figure 26 shows the redistribution in ship workload with the NAVOCEANO and commercial ships (and K-BOAT) performing all DOT installation and maintenance, while the ARIS performs the test support for which it is uniquely equipped.

(U) The first two years (1982 and 1983), the NAVOCEANO will be busy with Pacific DOT implants, thus the ARIS will perform Atlantic DOT

will

x  
MX is  
land-  
(launched).  
- does this  
imply BOA-3  
for MX?

from vol II

# UNCLASSIFIED

Table 47

(U) DOT INSTALLATION PLAN

Resource	Location	Initial Operating Capability	Responsibility
NAVOCEANO (Silas Bent)	LP-11 } LP-12 }	Nov-Dec 1981 }	PMTC/NAVOCEANO
	Oeno } Wake }	Mar-Jun 1982 }	
K-boat	KMRN	Aug 1982	KMRD/WSMC
Equipment transition		Jun 1982-Jan 1983	PMTC/NAVOCEANO
Commercial ship	BOA-1 } BOA-2 } BOA-3 }	Jan-Jun 1983	PMTC
	BOA maintenance } SLTA implants } Atlantic BOAs }	Post-Jun 1983	PMTC: Pacific ESMC: Atlantic

UNCLASSIFIED



KMRN =  
KMR North.

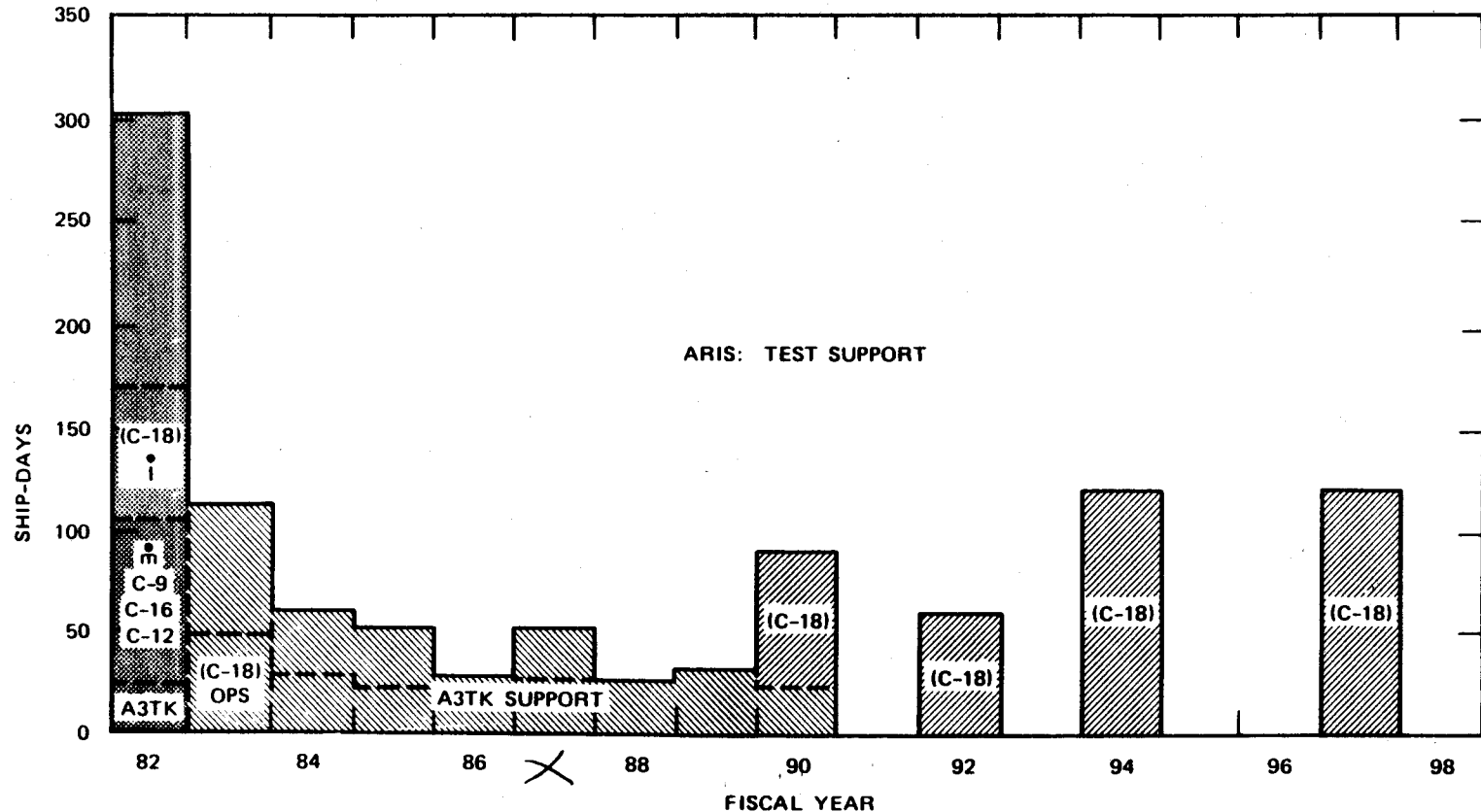
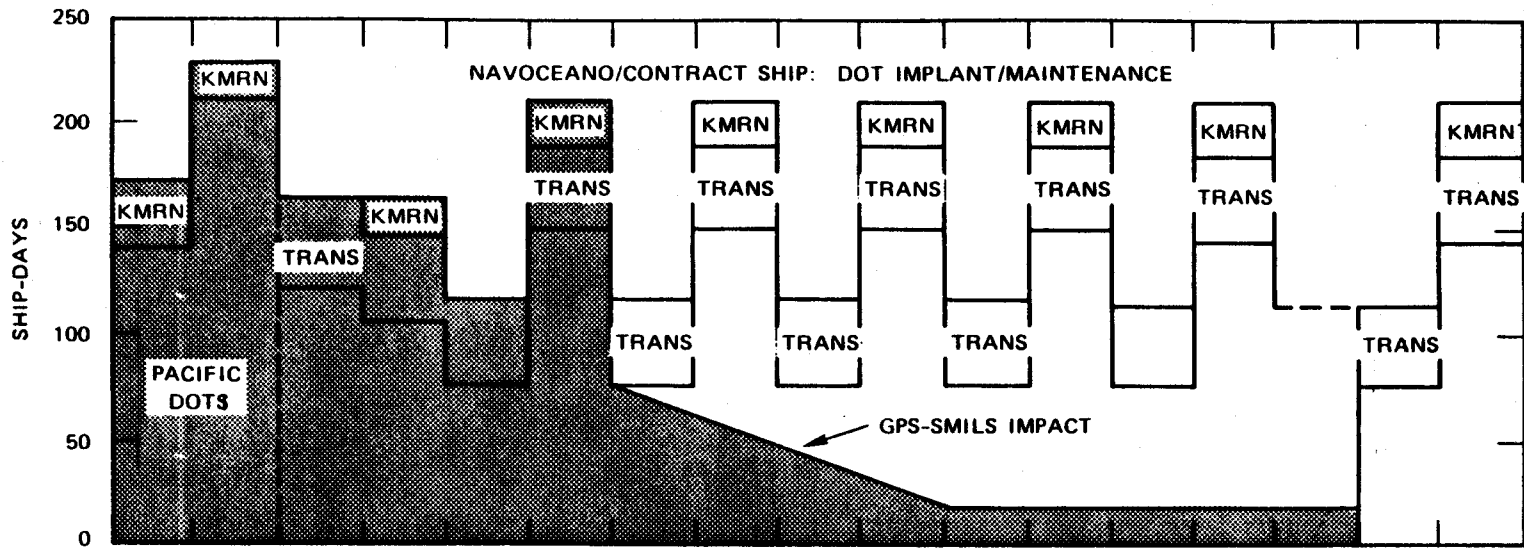

UNCLASSIFIED

173

UNCLASSIFIED

UNCLASSIFIED

FIGURE 26 (U) REDISTRIBUTION OF SHIP WORKLOADS

# UNCLASSIFIED

(U)

maintenance until 1984, when a low-cost contract vessel will be available with the DOT installation gear. Atlantic-to-Pacific transit times are included, which assume only one commercial vessel is employed.

(U) In 1988 there is a potential reduction in the commercial DOT vessel workload because of a GPS-SMILS system being developed by WSMC. This scoring system uses small GPS translators on two or three of the sonobuoys deployed by the P-3 aircraft. The GPS sonobuoys then provide their own geodetic reference for scoring and thereby eliminate the need for DOTs in the terminal areas. The shaded portion of the DOT workload plot reflects this potential reduction for even greater savings to the nation. A residual DOT maintenance service will still be required for the launch point DOTs used to locate the TRIDENT submarine.

(U) Several alternatives for the ARIS can be recommended. First, by using the smaller vessels for DOT work, the Arnold can be retired after a special mission in early FY82.

### 3. Costs of Alternatives to Baseline ARIS (U)

(U) The alternative cost data are in a format comparable to that used to describe baseline ARIA costs and reflect the workload identified for the alternatives considered. ARIS alternatives included a NAVOCEANO or commercial ship used for Pacific DOT installation and general DOT maintenance in both oceans. A K-BOAT concept was also considered as an alternative to the NAVOCEANO for KMRN DOT installation and maintenance.

(U) Table 48 shows NAVOCEANO or commercial ship nonrecurring, fixed annual, and variable annual cost estimates. Table 49 summarizes the per-mission variable costs for the NAVOCEANO or commercial vessel and the remaining ARIS. When applied to workload schedules, data in these

# UNCLASSIFIED

# UNCLASSIFIED

(U)

tables can be used to generate the alternative LCC curve shown in Figure 27.

Ex 5

UNCLASSIFIED

FIGURE 27 (U) ALTERNATE SHIP PLAN LIFE-CYCLE COSTS (cumulative)

(U) The alternate LCC curve in Figure 27 also includes the non-recurring and recurring costs for the K-BOAT concept. The costs associated with K-BOAT system development and use at KMRN in lieu of the NAVOCEANO or commercial vessel are presented in Section VI. The LCC of supporting the KMRN DOT with the K-BOAT versus the share of LCC incurred from using the NAVOCEANO or commercial vessel for KMRN DOT installation and maintenance has been shown to amortize the K-BOAT investment within two years.

DEL.  
175  
176

# UNCLASSIFIED

*[Handwritten signature]*

## VI SUPPLEMENTAL LAND-BASED ALTERNATIVES (U)

### A. Supplemental Land-Based Instrumentation Concepts (U)

(U) The SSTSS also addressed the possibilities of reducing the expensive mobile instrumentation resource support in the Pacific, such as the ARIA, P-3 SMILS, and range instrumentation ships. The concept involved supplemental instrumentation resources that could be operated more economically from some of the many other Pacific islands. Two types of supplemental land-based concepts were considered: (1) a Supplemental Land Terminal Area (SLTA) that was self-sufficient; and (2) an Adjunct Terminal Area (ATA) that was dependent on nearly, existing, land-based instrumentation.

#### 1. SLTA Locations and Targeting Constraints (U)

(U) One of the driving design aspects of these supplemental instrumentation concepts was the distance of the RV impact area from land due to maintaining range safety requirements. This driving factor affected the coverage that could be provided by land-based scoring or telemetry concepts that were limited by line-of-sight. At the outset of this study, safety stand-off restrictions for close-in targeting in these terminal areas were uncertain. Targeting stand-off patterns varied, depending on the WSMC Missile Flight Control (MFC) system capability available at the launch point (VAFB). Launch safety systems that were considered varied from the existing manual or auto-abort with unverified missiles, telemetry inertial guidance (TMIG) data, to sophisticated

**FIGURE 28 (U) PACIFIC SUPPLEMENTAL TERMINAL AREA OPTIONS**

(U)

safety systems being developed by WSMC that used verified TMIG data with a computer-aided automatic abort if required. Automatic abort would allow much closer-in targeting, but was not acceptable to the MX Program Office because of the increased possibility of loss of nominal missiles. This issue resulted in establishing KMRN as a MX target point.

---

(U) Table 50 provides a means to relate the major functional components of the major support alternatives investigated. These principle support alternatives were:

- (U) BOAST: Broad Ocean Area Scoring and Telemetry.
- (U) PILATS: Portable Impact Location and Telemetry System.
- (U) SDR/LBTS: Splash Detection Radar and Land-Based Telemetry System.

Table 50

(U) COMPOSITION AND TECHNICAL COMPARISONS OF SLTA OPTIONS

Elements		Support Alternatives							Technical Assessment	Risk
		BOAST	PILATS	SDR/LBTS	C-7A/SMILS	C-7A/MILS	C-7A/SADOTS	SAILS/LBTS		
Telemetry	LBTS	(X)	X	X	(X)	(X)	(X)	X	Adequate to horizon, 2 RVs	Low
	HATS CATS	X			X	X	X		Marginal supplement, 1 RV Adequate supplement, 4 RVs	High Med
Scoring	SMILS MILS SADOTS SDR DME/SMILS	X	1	2	X	X	X	X	50-ft accuracy, adequate stand-off 50-ft accuracy, adequate stand-off 50-ft accuracy, adequate stand-off 100-200-ft accuracy, marginal performance 50-ft accuracy, adequate stand-off	Low Low Med Med Med-high
	Support Resource									
Applicability	Barge		⊗						 ( ) = Required for use at NMI. ⊗ = Logistics support only.	
	Helicopter C-7A	2		⊗	X	X	X	X		
	Land-based	X	X	X	X	X	X	X		
Applicability	NMI	X	X	X	X	X	X	X		
	KMRN	X			X	X	X			

UNCLASSIFIED

UNCLASSIFIED

183

UNCLASSIFIED

# UNCLASSIFIED

- (U) C-7A/SMILS: C-7A aircraft with supplemental telemetry and a Sonobuoy Missile Impact Location System.
- (U) C-7A/MILS: C-7A aircraft with supplemental telemetry, used with a hard-wired Missile Impact Location System.
- (U) C-7A/SADOTS: C-7A aircraft (supplemental telemetry) with airborne readout of a Splash-Activated Deep Ocean Transponder System.
- (U) SAILS/LBTS: SADOT Acoustic Impact Location System and LBTS.

(U) The SLTA support alternatives differed mainly in the mix of schemes to provide the basic BOA functions of RV telemetry (from reentry to impact) and RV scoring. All concepts provided for streak optics, range communications, and range clearance of the impact area, and therefore these aspects will not be discussed.

a. Telemetry Concepts (U)

At KMRN, the telemetry system existing at KMR provided this function. These functional systems are correlated with the support alternatives in Table 49.

(U) Two airborne supplemental telemetry schemes were used for the various alternatives to provide the last few thousand feet of RV trajectory coverage: a helicopter airborne telemetry system (HATS), used only with the BOAST concept; and a Caribou (C-7A) aircraft telemetry system (CATS), used with the C-7A/SMILS, /MILS, and /SADOTS. These airborne supplemental telemetry systems require only low-gain (broadbeam) type antennas because the RV plasma telemetry blackout will have ended allowing relatively short aircraft standoff distances.



# UNCLASSIFIED

## b. Scoring Concepts (U)

(U) Five RV impact scoring concepts were investigated (Table 49); four of these (SMILS, MILS, SADOTS, and DME/SMILS) employ acoustic signals from RV impact to locate the impact position, and could be employed beyond line-of-sight from land. The SDR, as the name implies, can only score impacts sufficiently close to land that the splash plume is visible to the radar. The SDR can cover 30 to 40 nmi with suitable site elevation (about 1000 ft) and plume heights of about 100 to 200 ft.

(U) The SMILS system (described in connection with baseline P-3 scoring aircraft) employs air-deployed sonobuoys over an array of pre-installed and surveyed DOTs. Acoustic pingers on some of the sonobuoys interrogate the DOTs to achieve a geodetic reference for the pattern of 10 to 14 sonobuoys.

(U) The acoustic impulse received from an RV impact is transmitted over UHF links to the stationkeeping aircraft using standard sonobuoy equipment, plus some special palletized recorders and instrumentation. The SMILS scoring can be used anywhere that a DOT array has been installed and maintained by a suitably equipped ship. Figure 31 shows the C-7A SMILS concept including the supplemental telemetry and streak optics. Its low investment and operational costs ranked it highly as a low risk, flexible, and economically attractive concept. A P-3 SMILS could also be used in this concept.

(U) The DME/SMILS is also based on the concept of air-deployed sonobuoys, but avoids the need for DOTs by locating the sonobuoy pattern with RF distance measuring equipment (DME) from two or more land-based or airborne platforms (such as helicopters in the BOAST concept), which are in turn located by a DME in reference to the remote land sites. This concept can only be used where sufficient land sites are within line-of-sight of a pair of helicopters and provide suitable geometry for triangulation.

(U) The MILS concept uses only deep ocean (bottom mounted) acoustic transducers to detect and locate the RV impact. These transducers are hard-wired by undersea cables to a remote land site where the data are recorded, time tagged, and processed for scoring. The MILS advantage is that once installed, no aircraft resources are necessary to perform scoring. Maintenance is very low, and the system has been well proven. The disadvantage is a large initial cost to acquire and install the cable network from the MILS array back to the beach.

*off kway*

(U) The SADOTS is similar to the MILS, but replaces the cable network with an acoustic link to the sea surface. The SADOTS was originally designed for the Navy FBM programs to provide an aircraft-independent

# UNCLASSIFIED

(U)

scoring system at C18, which at the time could not be reached by P-3 SMILS due to the restriction on aircraft staging out of South Africa. The SADOTS consists of ship-installed array of deep ocean acoustic transducers that incorporated a splash signal memory. In operation, the ship arrives prior to a test, initiates the SADOTS, and synchronizes self-contained clocks via an acoustic communicator on the vessel. The ship then retreats to its test support position to collect telemetry, etc. After impact, the ship returns to the array and reads out the time-tagged signals via its acoustic link.

(U) Two variants of the SADOTS concept were investigated by the SSTSS: C-7A/SADOTS and the SAILS/LBTS (Figure 33). These variants perform SADOTS initialization and post-impact readout by a permanently tethered subsurface buoy, which in turn has a surface-floating tethered RF relay link. The variants differ in whether a C-7A aircraft or a line-of-sight land-based control and readout is used. The principal concerns over the SADOTS concept variants were that they had not been demonstrated and the dependability and life of a permanently tethered buoy was questionable. Furthermore, they had no operational advantages over the basic SMILS concept, except the elimination of air-deployed sonobuoys.

(U) The PILATS concept (Figure 34), presented early in the study by KMRD, embodied an ocean-going barge (landing craft) to transport an instrumentation suite to a remote island location. The equipment consisted of an SDR for scoring up to about 12 nmi from a sealevel site, an LBTS, and a low-gain supplemental telemetry antenna on a 100-ft tower to obtain data near impact. Additional equipment was a meteorological rocket launcher, an optical camera integrated with a small tracking radar, and a self-sufficient power generation system.

Ex 51

11/27

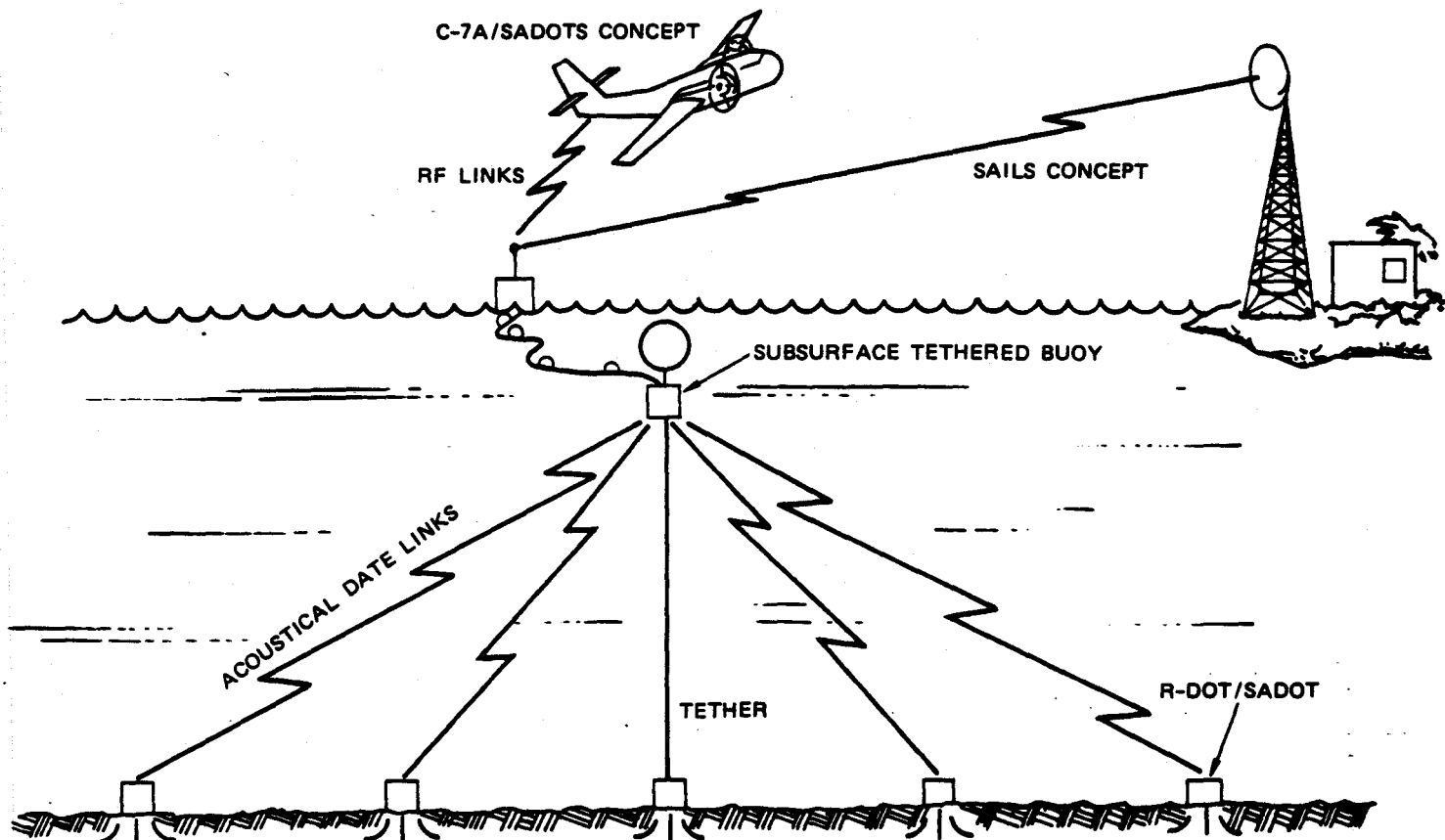

UNCLASSIFIED

FIGURE 33 (U) C-7A/SADOTS AND SAILS CONCEPTS

B. Recommended Mobile Instrumentation Support at KMRN (U)

(U) The instrumentation support required for the MX test support at KMRN are:

- (U) Streak optics.
- (U) Impact scoring on all RVs.

(U) Since the MX employs a higher energy and more dynamic booster, as well as a more capable bus, than the MINUTEMAN boosters, impacts near or into the KMR lagoon cannot be accommodated with the current range safety system at WSMC. Also, since an automatic abort mode is not acceptable to the MX program office, the MX impact area will probably remain at the KMRN BOA.

# UNCLASSIFIED

(U) Telemetry coverage from the KMR land-based sites can be used for RV altitudes down to about 2000 to 3000 ft. Consequently, some supplemental telemetry collection must be provided for the last few thousand feet. The basic approach established between WSMC and the MX program office consisted of using a P-3 SMILS aircraft equipped with a streak optics camera and a supplemental telemetry system, as has been used in the Atlantic by VX-1 P-3C SMILS for FBM support.

(U) This baseline approach would involve a scoring DOT array to be installed and maintained at KMRN by a ship. The costs of supporting KMRN with these planned resources will be used as the basis for comparing the economic value of the alternative support concepts.

(U) The SSTSS involvement in KMRN developed for several reasons:

- (U) The cost of ship-installed and -maintained DOTs for RV scoring was very high.
- (U) Opportunities were being investigated for reducing the mobile aircraft workload by supplemental land-based instrumentation concepts on the small islands around Kwajalein Atoll.
- (U) The advantages of supporting a nearby BOA from KMR rather than CONUS seemed economically and operationally attractive.

(U) The recommended alternative for MX support at KMRN consists of three primary elements:

- (U) A C-7A terminal area support aircraft (TASA) equipped with:
  - Supplemental telemetry system
  - SMILS scoring capability
  - Streak-optics camera system.
- (U) A KMR BOA tug (K-BOAT) for:
  - Initial DOT installation
  - Continued DOT maintenance.

# UNCLASSIFIED CONFIDENTIAL

## 1. C-7A TASA (U)

### a. C-7A TASA Design (U)

ⓐ The concept of using the C-7A Caribou aircraft (of which seven currently exist at KMR) as an alternative to mobile (U.S.-based) instrumentation aircraft support was developed by KMRD. This alternative was recommended for several reasons: (1) it was a low-cost, low-risk option based on proven concepts; (2) it would serve as a backup for scoring support elsewhere in the Pacific; and

(U) Figure 35 shows the TASA supporting the KMRN BOA by providing supplemental telemetry (below KMR coverage), SMILS scoring, and streak optics. Design and implementation for the concept is already underway, and the details of the major subsystem designs are described in the "Caribou TASA Study," BMDSCOM-R (23 October 1980);<sup>4</sup> "C-7A TASA Status Report," BMDSCOM-R (4 February 1981);<sup>5</sup> and "C-7A TASA Design Freeze," BMDSCOM-R (21 April 1981).<sup>6</sup>

(U) The general C-7A TASA design layout and the locations of the instrumentation subsystems are shown in Figure 36. In summary, the TASA provides accurate scoring; reliable high-gain, narrow-beam telemetry; and streak photography for the terminal portion of multiple-IRV trajectories. The SMILS scoring accuracy will be within 45 ft throughout the array, with improved accuracies near the center. Telemetry data with  $1 \times 10^{-5}$  bit-error-rate will be provided from 4.5 kft to postimpact for up to 3 RVs impacting within a 12-nmi diameter area. Streak photography will be obtained from 62 kft to impact, based upon a  $30^\circ$  reentry angle for multiple-IRVs.

(U) Telemetry System. The C-7A TASA's telemetry system employs a Luneberg lens and is capable of receiving and recording up-to-three S-band telemetry RF links simultaneously. Both right- and left-hand circular (RHC and LHC) polarization signals are received from the antenna and made available at the telemetry RF patch panel. All signals within the system are patchable to provide configuration flexibility. Six solid-state telemetry receivers will be used in the system: two

UNCLASSIFIED

194

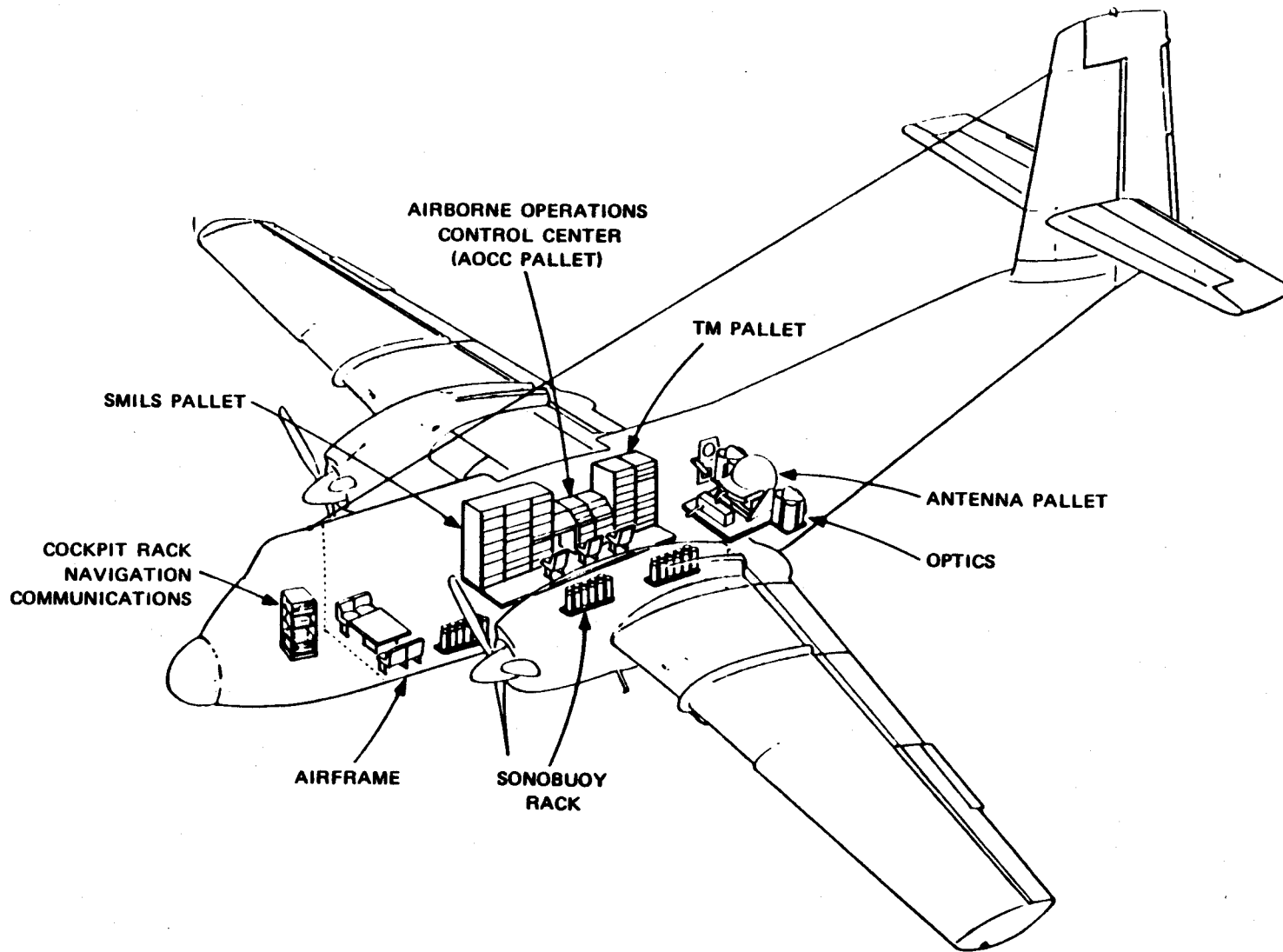

UNCLASSIFIED

FIGURE 36 (U) C-7A TASA DESIGN CONFIGURATION

UNCLASSIFIED

(U)

receivers will support the RHC and LHC signals for each of the three telemetry links. Multicouplers are used to maintain proper signal levels to the receiver inputs. Three dual-diversity combiners provide simultaneous pre- and post-detect combining of the RHC and LHC signals for each of the telemetry links. This provides redundancy for signal combining and up to 3 dB improvement in the signal-to-noise ratio (S/N). Redundant 14-track wideband magnetic tape recorders used to record the data are capable of reliable operation in a hostile environment and meet the current IRIG standards. Receiver automatic gain control (AGC), range timing, voice, and reference signals will be multiplexed by the data insertion converter (DIC) and recorded on both recorders. An S-band signal generator will also be provided for on-board signal strength calibration and confidence testing.

SMILS Scoring System. The SMILS system, designed to meet or exceed all user scoring requirements, will provide the accurate position of impacts occurring within the 14-nmi sonobuoy array with no limitation to the number of RVs scored.

The TASA aircraft can support a mission window of 8 h at KMRN, exclusive of the sonobuoy seeding time.

(U) Streak Optics System. Terminal streak photography is the only optics requirement for the MX program. The coverage will be provided by a camera system available from the KMR inventory: a Fairchild T-11 aerial camera. The T-11 camera has a 74° field-of-view and a 9 in. x 9 in. format. A backup camera will also be used with a 4 in. x 5 in. format and a 70° field-of-view.

in addition to terminal streak coverage, would use cine-spectral and documentary (sequential) coverage if available. This capability is being considered for future C-7A TASA implementation.

(U) Navigation Systems. The primary navigation will be done by the pilots using the Inertial Navigation System (INS) and the Omega Navigation System (ONS) located in the C-7A cockpit. When the pilot has navigated to the vicinity of the DOT array, an air-deployed interrogator



# UNCLASSIFIED

(U)

(ADI) sonobuoy will be deployed, and the TASA supervisor will determine its precise position using the DOT navigator and the computer. This position will be plotted and updated periodically at the Air Operations Control Center (AOCC). The pilot will then fly over the ADI using the homing system and the on-top position indicator (OTPI). The primary navigation systems will be updated with the current ADI position. Sonobuoy pattern seeding will proceed in a similar fashion, using the same instrumentation. The TASA supervisor at the AOCC will maintain track of all sonobuoys deployed using the plotboard.

(U) The homing system uses the RF signals from the selected sonobuoy, received via a dual antenna and loading unit that creates a null along the longitudinal axis of the aircraft. This null pattern drives a receiver and a left-right homing indicator. A complementary system utilizes the Doppler shift in the C-7A propeller noise received through the sonobuoy for a precise "on-top" indication.

b. KMRN C-7A TASA Cost Analysis (U)

(U) The C-7A TASA offers an alternative to the P-3 SMILS for scoring RVs landing in the KMRN DOT array. A question that must be answered is how the two alternatives compare in terms of cost. Relevant costs for comparison include only those additional changes that the nation must pay for each alternative, because of support being provided by each alternative at the KMRN DOT array.

(U) The C-7A TASA concept is specifically developed for KMRN support. All nonrecurring costs (associated with engineering design, test, training, and support hardware acquisition) and such event-dependent variable costs (as aircraft flying costs and mission expendable costs) must therefore be included. The P-3 SMILS capability, on the other hand, must be developed to satisfy national requirements regardless of whether a support requirement exists at KMRN. The only nonrecurring item of the baseline P-3 SMILS, whose acquisition is required specifically because of the KMRN support concept, is a supplementary telemetry

# UNCLASSIFIED

# UNCLASSIFIED

(U)

system. Event-related variable costs for the C-7A TASA include aircraft flight costs and mission expendables. For the P-3 SMILS, crew per-diem costs must also be paid. These cost data are summarized in Table 51.

(U) The cumulative costs to the nation over time associated with KMRN support by the C-7A TASA and P-3 SMILS alternatives are depicted in Figure 37. The curves reflect the initial nonrecurring expenditure to acquire the capability needed for KMRN support followed by the annual recurring costs. The recurring costs added each year are a product of the Table 51 event-related costs and the KMRN event schedule in Table 52.

UNCLASSIFIED

FIGURE 37 (U) C-7A TASA VERSUS P-3 SMILS COST COMPARISON FOR KMRN SUPPORT.  
[Only costs directly related to support of KMRN events are included for each alternative (e.g., no fixed recurring costs).]

# UNCLASSIFIED

(U) Figure 37 shows a slightly higher total projected cost to the nation for developing and using a C-7A TASA than for using the existing P-3 SMILS assets. Note, however, that this result is quite sensitive to two factors: cost estimating error and KMRN workload. An error of approximately 20% in estimating either nonrecurring costs or the projected workload will equalize the costs of these alternatives.

(U) Figure 37 also shows a significant difference in slope of the two curves after acquisition of the two alternatives, i.e., the P-3 SMILS capability is approximately three times as expensive to use as the C-7A TASA. This cost differential is borne by the users--the ICBM and SLBM programs. Such a difference, if available to the user, may influence the demand for the C-7A TASA alternative over the long term, thereby increasing its value in terms of return on the initial investment paid by the taxpayer. In addition, as discussed elsewhere, the C-7A TASA provides a backup Pacific SMILS scoring capability, enhancing support reliability and scheduling flexibility, as well as providing the opportunity for substantial additional economic benefits to the nation when the TASA is also used at a supplemental land terminal area (SLTA) to be discussed later in this section.

## 2. Kwajalein Broad Ocean Area Tug (K-BOAT) (U)

### a. K-BOAT Design (U)

Ey 5  
(U) The concept of using an existing ocean-going tug for the SMILS DOT array installation and maintenance at KMRN (Figure 38) was proposed by KMRD. the costs avoided by using a KMR-based tug versus the cost-effective NAVOCEANO vessel would easily pay for the investment within two years. Upon reviewing the technical aspects of the design and operational plan by KMRD, the SSTSS Working Group recommended this K-BOAT approach.

(U) In operation, the K-BOAT deploys the DOTs over the stern, after the ocean bottom has been premapped for suitable depths and profiles. The DOTs are then surveyed by a bottom-mounted transponder for acoustic ranging, after taking a sound velocity profile from the bottom to the sea's surface.

# UNCLASSIFIED

**FIGURE 38 (U) K-BOAT INSTALLATION OF DOTs AT KMRN**

(U) The geodetic location of the tug is achieved without the sophisticated satellite navigational systems and SINS needed by at-sea vessels. This is done quite well by using an electronic RF DME multilateration scheme from the tug to Defense Mapping Agency (DMA) benchmarked RF transponders on three near-by islands--Likiep, Taka, and Roi-Namur. The RF signal propagation over water for HF ranging systems (like the ARGO DM-54) can reach up to 200 nmi and even farther at night, not being restricted by line-of-sight conditions. The tug's position has been estimated to be measurable to within 3.7 m. This is better than

(U)

that achieved by broad-ocean DOT survey vessels. In addition to the precise x, y positioning, the effects of vertical motion induced by seas (ship roll, pitch, and yaw) will be included.

b. K-BOAT Cost Analysis (U)

(U) The opportunity to use the K-BOAT concept in lieu of the NAVOCEANO ship to install and maintain the KMRN DOT array raises the question of what the alternative costs will be. These costs are documented here, using the same rationale as for the C-7A TASA discussed above, i.e., the relevant costs are only those the nation must incur because of support provided at the KMRN DOT array.

(U) The nonrecurring development costs for providing an existing KMR tug with the necessary subsystems for DOT installation and maintenance at KMRN are summarized in Table 53, along with the recurring costs per DOT service mission. The recurrence of DOT maintenance trips has historically been on the average of 2 to 3 years. The average DOT life is purported to be 5 years, so that several units (out of the 10 to 14 used) can be expected to fail every few years.

Ex 5

(U) Figure 39 indicates that the total additional costs to the nation from either of these alternatives are approximately equal. The K-BOAT is slightly less expensive and offers a more flexible support

W

Ex 5

3. Transportable Telemetry System (TTS) (U)

(U) The last element of the KMR support plan for MX at KMRN is the TTS. This van-mounted telemetry system is planned for BMD program support and for use at Roi-Namur to improve the telemetry data quality for the MX MK-12A RV during plasma attenuation. Although the TTS was not an SSTSS topic, it is discussed here because it should be examined for potential capability to satisfy the LBTS role at the SLTA.

(U) Figure 40 depicts the TTS configuration design. The 20-ft diameter antenna system is expected to avoid data dropouts up to 96 nmi from the RV. The van provides mobility, and a diesel electric generator allows operation at unimproved sites. The design of the TTS feature disassembly into a shipping envelope that can be accommodated by large transport aircraft.

Σ

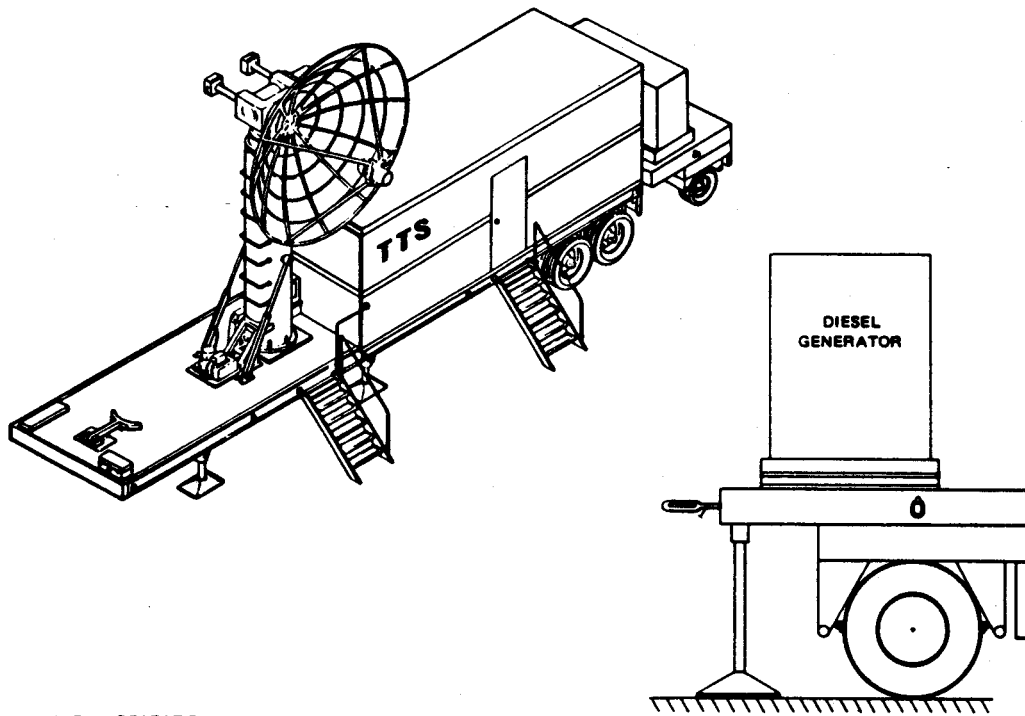

UNCLASSIFIED

FIGURE 40 (U) KMR TRANSPORTABLE TELEMETRY SYSTEM (TTS) DESIGN

4. KMRN Resource Development Schedule (U)

(U) Figure 41 shows an integrated development schedule for the TASA, K-BOAT, and TTS. Demonstration of the TASA and K-BOAT will be in late 1982. These resources will provide the basic MX requirements at KMRN. The TTS will be operational in early 1983.

C. Recommended SLTA Instrumentation Concept (U)

1. Design Evolution (U)

UNCLASSIFIED

205

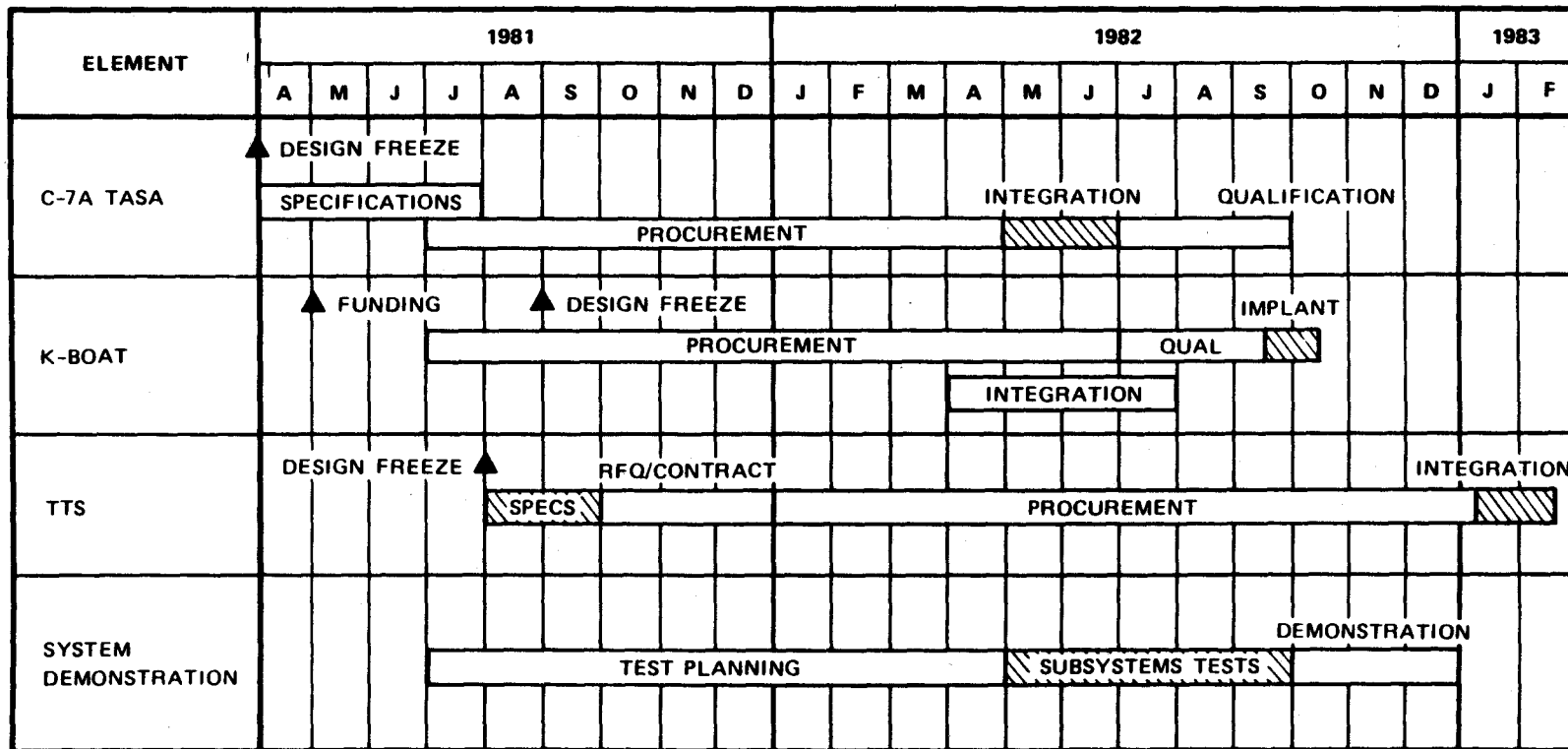

UNCLASSIFIED

FIGURE 41 (U) INTEGRATED DEVELOPMENT SCHEDULE FOR KMRN

UNCLASSIFIED



(U) Of the various SLTA instrumentation alternatives examined, the concept most consistently accepted among the SSTSS Working Group was the use of LBTS optics and communications, plus either a MILS or SMILS scoring system. Supplemental telemetry and surveillance would be provided with a low-cost aircraft platform.

Concerns over this approach by the SSTSS Working Group were:

- (U) Confidence of depending on the planned WSMC upgraded range safety system (multidata processing system/missile safety system, MDPS/MSS) to achieve the close-in targeting required by the 30-nmi target.
- (U) Possible growth of operation costs.

(U) Of the various SLTA instrumentation alternatives examined, the concept most consistently accepted among the SSTSS Working Group was the use of LBTS optics and communications, plus either a MILS or SMILS scoring system. Supplemental telemetry and surveillance would be provided with a low-cost aircraft platform.

-----

Concerns over this approach by the SSTSS Working Group were:

- (U) Confidence of depending on the planned WSMC upgraded range safety system (multidata processing system/missile safety system, MDPS/MSS) to achieve the close-in targeting required by the 30-nmi target.
  - (U) Possible growth of operation costs.
- - - - -

(U) The schedule proposed by WSMC for SLTA implementation requires about 2.5 years from initial equipment funding. A FY84 funding would permit a mid-1986 IOC.

for Map. 24.2.

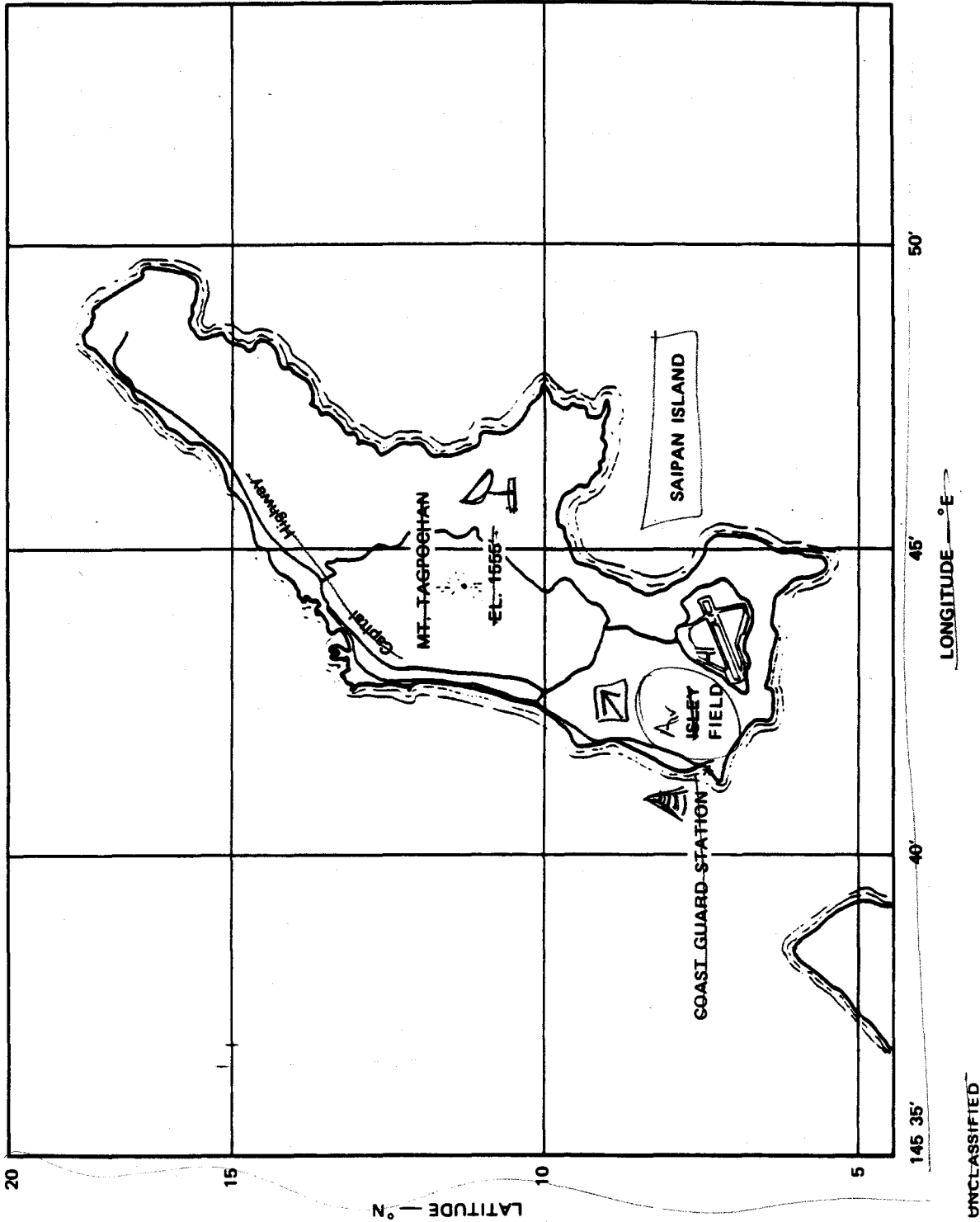

FIGURE 43 (U) SAIPAN GEOMETRY AND POTENTIAL SITE LOCATIONS

XR

A = Loran C readaid.

SLTA  
Supplemental Land  
Terminal Area

4. SLTA Cost Analysis (U)

(U) The comparison associated with the SLTA concept concerns the cost of supporting operations at BOA-1 and -2 with either of the two aircraft fleet options preferred by the URIA analysis (Options IV and VII) versus supporting events at a SLTA and one BOA. In the latter instance, the SLTA would be supported by ground instrumentation and the C-7A TASAs; the BOA would be supported by either Option IV or VII aircraft fleet elements.

(U) The number of aircraft missions to BOA-1 and -2 (with no SLTA) was first determined for a baseline workload. Then the number of aircraft missions to BOA-2 were determined for the case where the SLTA was implemented and replaced BOA-1. These aircraft missions are shown in Table 54.

(U) The number of times BOA-2 (recently renamed BOA-4 and moved about 800 nmi uprange of SLTA) is used diminishes when the SLTA is available, thereby avoiding the higher cost of aircraft support. These scheduled-use estimates are also shown in Table 54 under the "with SLTA" column.

(U) The costs to the nation that are relevant to the SLTA analysis include (1) the costs of building and maintaining the supplemental land terminal facilities, (2) the costs of one ARIA or EATS(U) phased-array telemetry system (that can likely be avoided if SLTA is implemented), and (3) the event-related support costs of using the ARIA or P-3 aircraft at the BOAs or the C-7A TASA at the DOT array near the SLTA (if it has been developed for use at KMRN). Cost data are summarized in Table 55.

(U) Applying Table 55 data to the schedule of events shown in Table 54 yields the cost data in Figure 44. Four curves are shown in Figure 44, each reflecting cumulative costs to the nation for a different situation. The upper two curves reflect the cost of supporting BOA-1 and -2 with either URIA fleet Option IV (ARIA/APATS/SMILS) or URIA fleet Option VII (ARIA/SMILS, using the nose dish for single RV events, or the EATS[U]/SMILS, using its phased array for multiple RV events). The

Table 54

(U) AIRCRAFT SUPPORT EVENTS AT BOA-1 AND -2 WITH AND WITHOUT SLTA

Fiscal Year	No SLTA						With SLTA			
	Option IV: ARIA/APATS		Option VII: EATS(U) & ARIA/SMILS				Option IV	Option VII		SLTA
	BOA-1	BOA-2	BOA-1		BOA-2		BOA-2 ARIA	BOA-2		
			EATS	ARIA	EATS	ARIA		EATS(U)	ARIA	
82	--	--	--	--	--	--	--	--	--	
83	--	--	--	--	--	--	--	--	--	
84	2	1	1	1	0	1	1	0	1	2
85	4	3	1	3	2	1	3	0	3	4
86	1	1	1	0	1	0	1	1	0	1
87	7	7	5	2	4	3	4	1	3	9
88	8	7	6	2	4	3	4	1	3	10
89	8	7	5	3	4	3	4	1	3	10
90	5	3	3	2	2	1	2	0	2	6
91	6	3	3	3	2	1	3	1	2	6
92	6	3	4	2	2	1	3	1	2	6
93	5	3	2	3	2	1	2	0	2	6
94	5	3	3	2	2	1	2	0	2	6
95	6	3	3	3	2	1	3	1	2	6
96	5	3	3	2	2	1	2	0	2	6
97	6	3	3	3	2	1	2	0	2	7
98	5	3	3	2	2	1	3	1	2	5
99	5	3	2	3	2	1	2	0	0	6

• URJA Option IV

BOA-2 events supported by ARIA/APATS/SMILS; SLTA supported by C-7A.

• URJA Option VII

BOA-2 events supported by EATS(U)/SMILS and ARIA/SMILS. All single IRV tests supported by ARIA/SMILS. Multiple IRVs supported by EATS(U)/SMILS. SLTA supported by C-7A TASA.

UNCLASSIFIED

UNCLASSIFIED

UNCLASSIFIED

AS

FIGURE 44 (U) COST COMPARISONS FOR BOAs-1 AND -2 vs SLTA AND BOA

(U)

remaining two curves in Figure 44 show the cost of supporting a SLTA (with RV impacts in the nearby DOT array scored via KMRD's C-7A TASA) and one BOA (supported with the same URJA fleet options as for the dual-BOA case).

(U) Figure 44 reveals a sizable payoff to the nation and to the user (who must reimburse variable costs) if the SLTA concept can be used to satisfy test support requirements. Given the SLTA concept development schedule, the MX OT&E community will be the primary beneficiary of any reduced DCR costs. The major advantage to the nation occurs because of the probable avoidance of the fourth APATS system (if URJA fleet Option IV should be selected) or the third upgraded EATS antenna (if URJA fleet Option VII is selected).

# UNCLASSIFIED

## VII MISCELLANEOUS TOPICS (U)

### A. EATS/APATS Telemetry Performance Comparisons (U)

#### 1. Analysis Overview (U)

(U) A comparative analysis was made of the performance of the U.S. Navy EATS multibeam phased-array telemetry antenna, currently under development by PMTC, Pt. Mugu, California, and the planned APATS antenna intended for use by the U.S. Air Force ARIA fleet at 4950th TW, WPAFB, Ohio. The comparison was made in the context of a ballistic missile terminal area test support role for the collection of telemetry data from MK-4 and MK-12A IRVs during reentry. In this comparison, two levels of upgrade were examined for the EATS antenna--a minimum required upgrade (dual-polarization), and an upgrade including dual-polarization and increased elevation scan angle commensurate with the APATS specification. Study findings indicate that the second EATS upgrade option results in telemetry collection performance essentially equal to that of the APATS. RV telemetry blackout (S/N <13 dB) for the EATS upgraded (U) antenna lasted slightly longer than the blackout of the APATS antenna. Blackout is relatively unimportant in the MK-4 application, but may be more consequential in the MK-12A application. The minimum EATS antenna upgrade (dual-polarization) does not perform well for ballistic missile telemetry support, so the full upgrade is indicated for the EATS telemetry antenna in this mission role.

#### 2. General Description: EATS and APATS Antennas (U)

(U) The EATS telemetry antenna has been designed for installation on P-3A Orion aircraft to receive signals from surface and airborne telemetry transmitters located within the offshore extended area of the Pacific Missile Range in Southern California. The APATS antenna, for



# UNCLASSIFIED

(U)

which a performance specification has been written and design phase contractors have been selected, is to be installed on an EC135N or 707-320C aircraft to receive signals in the BOAs from telemetry transmitters placed on up-to-four instrumented objects, such as TRIDENT and MX reentry vehicles.

(U) The EATS antenna is a flat array built into a forward extension of the tail fin of the P-3A aircraft. It is a two-faced array, operating only one face (port or starboard) at a time, the choice being made by a switch. Each side has an area of about 7 m<sup>2</sup> and is designed to receive RHC polarization but not LHC polarization, using five simultaneous, independently scanning beams. The beams have a wide azimuth scan capability, but their elevation scan capability, while satisfying the EATS requirements, is limited for RV telemetry collection.

(U) In comparison, the APATS antenna will be single-faced, have only four simultaneous, independently scanning beams, and receive both RHC and LHC polarization with pre- and post-detection combining capability. The APATS beams will have a large scan capability in elevation as well as azimuth. The location and form of the APATS antenna have not been completely determined. It probably will be located on the right side of the fuselage, forward of the wing. It may be a conformal array, or it may be a flat array faired into the fuselage.

(U) A comparison of the antennas' gain behavior over a range of elevation scan angles is seen in Figure 45. The first postulated modified form of the EATS antenna (Mod-1) differs from the original only in that it meets the APATS dual-polarization requirements. It does not meet the APATS scan or sensitivity requirements with elevation scan angles above about 3°. The second form (Mod-2) meets both the dual-polarization and elevation scan angle requirements of the APATS (+45°, -15°). Mod-2, however, is no larger than the original EATS, and therefore falls short of meeting the APATS sensitivity requirement by 1.7 dB. The third form of antenna (Mod-3) simulates the yet-to-be-designed APATS, in that it meets the APATS sensitivity requirement at maximum off-axis scan angles and is dual polarized.

# UNCLASSIFIED

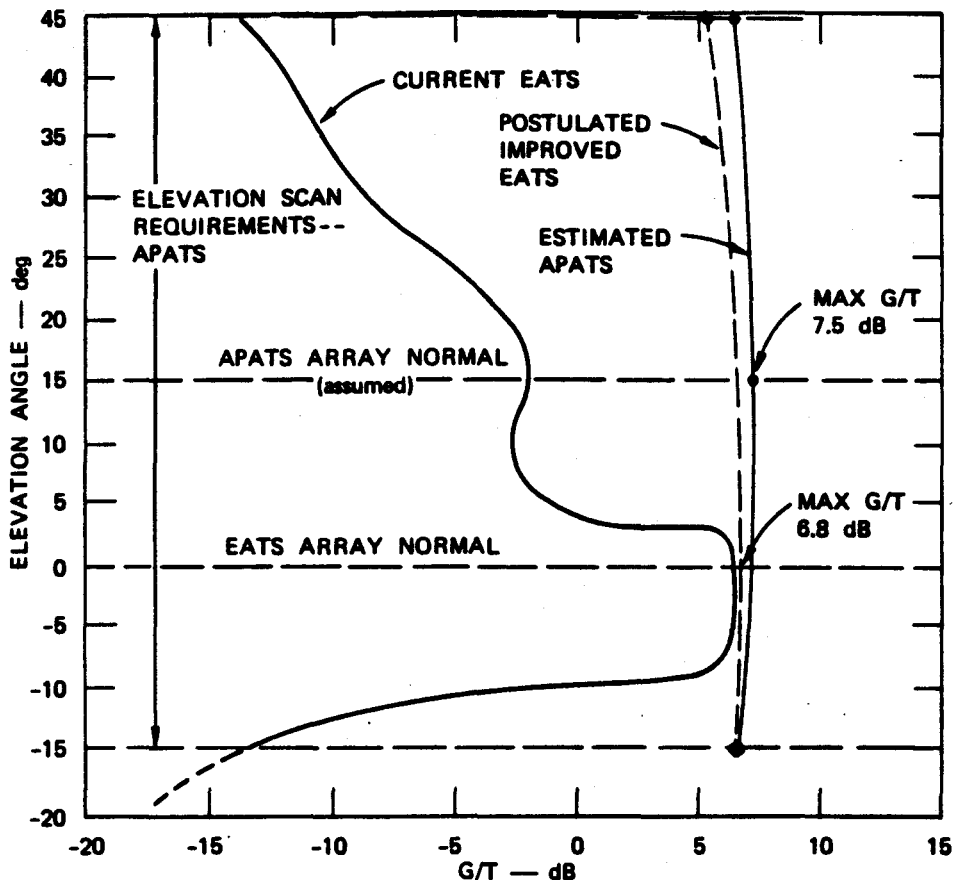

UNCLASSIFIED

FIGURE 45 (U) ELEVATION SCAN G/T PROFILES FOR EATS AND APATS ANTENNAS

### 3. Analysis Factors and Results (U)

(U) Parameters that vary during a reentry event were defined for this analysis (Figure 46) in terms of their geometric relation to the problem. These parameters are:

- (U) Test support position of the aircraft relative to the trajectory ground trace.
- (U) Plasma loss versus altitude and reentry conditions for Air Force (MK-12) and Navy (MK-4) RVs.
- (U) Respective RV telemetry antenna gains versus aspect angle.
- (U) Aircraft telemetry antenna gain as a function of elevation and azimuth look angles.

# UNCLASSIFIED

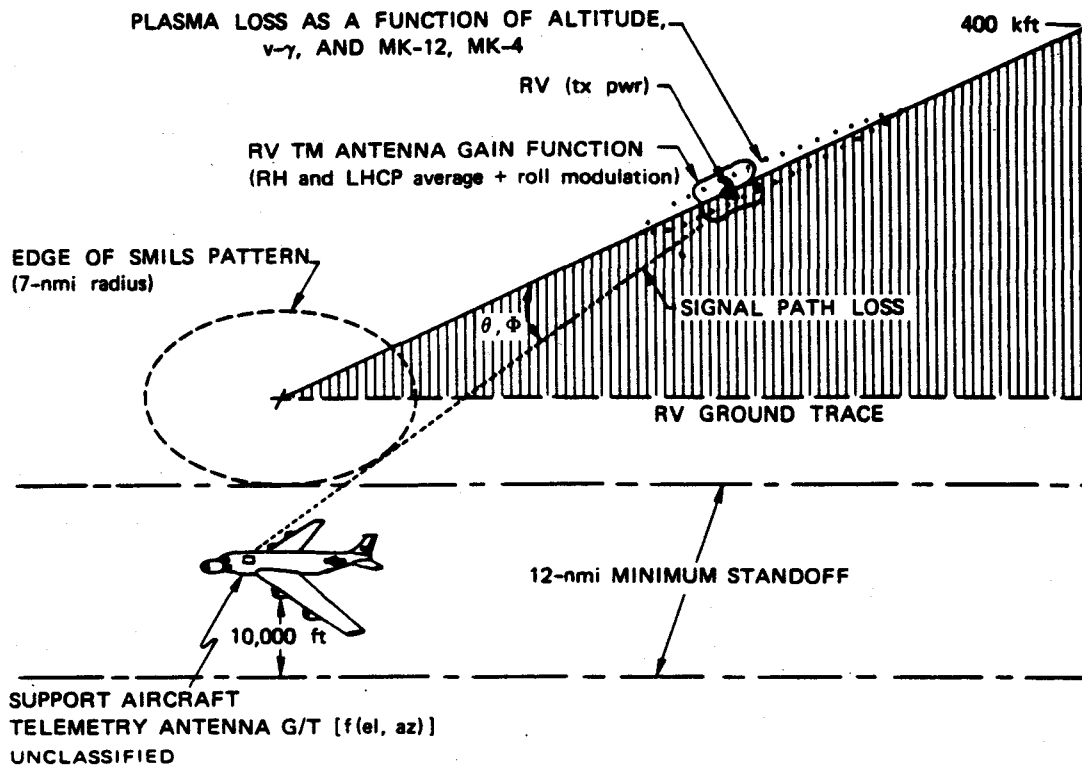
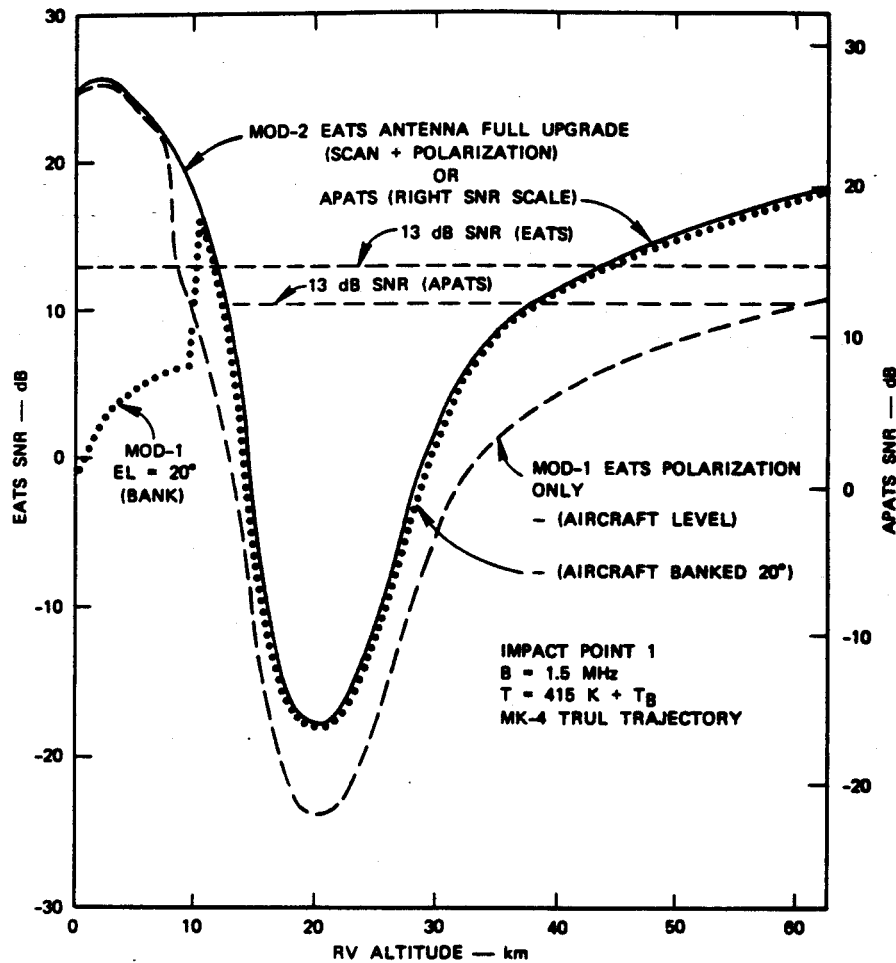

FIGURE 46 (U) GENERIC SUPPORT GEOMETRY

(U) Several representative reentry trajectory cases were analyzed for the MK-4 and MK-12A RVs for different impact points in the 14-nmi diameter scoring array. These analyses computed the S/N for the subject telemetry systems as a function of RV altitude. Figures 47 and 48 summarize these results for the MK-4 RV and the MK-12A, respectively.

(U) In Figure 47, the dashed and dotted curves show the predicted performance of the EATS antenna with the minimum upgrade (Mod-1, dual polarization only) for two situations--with the aircraft level (dashed) and with the aircraft banked  $20^\circ$  (dotted), as suggested by PMTC. Reading the EATS S/N from the left ordinate, Figure 47 shows that for Mod-1 (level aircraft case) during reentry plasma, the S/N is below the acceptable 13 dB (for  $10^{-5}$  bit error rate), at altitudes well above 60 km



UNCLASSIFIED

FIGURE 47 (U) EATS AND APATS ANTENNAS WITH MK-4 RV TELEMETRY

(U)

(about 180 kft). The S/N then rises rapidly as the RV descends below 10 km and the plasma loss subsides. This high-altitude poor S/N results in data blackout for a period longer than the MK-4 RV's delay link, which records on-board data during blackout and retransmits it (at a higher rate) after blackout, but before impact.

(U) When the EATS aircraft is banked  $20^{\circ}$  to accommodate the limited elevation scan capability, the S/N is improved for the higher RV altitudes, but suffers severely during the last 20 to 30 kft (10 km) when the delay link would be transmitting prior to impact. These findings indicate that the minimum EATS upgrade (Mod-1) is not satisfactory for MK-4 telemetry reception.

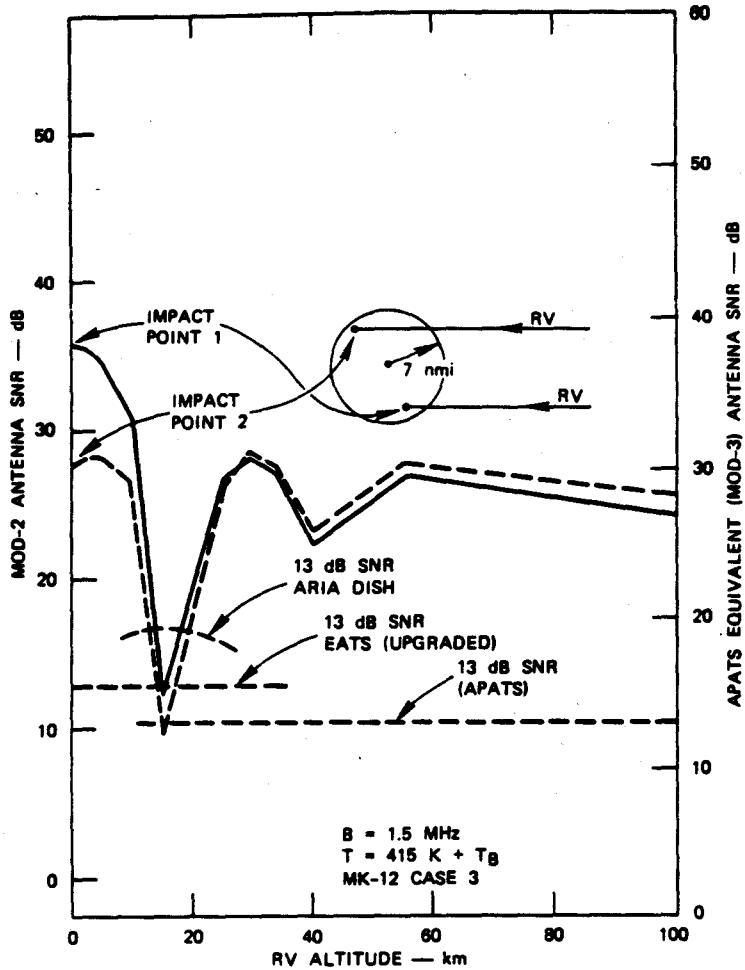

UNCLASSIFIED

FIGURE 48 (U) EATS AND APATS ANTENNAS WITH MK-12A RV TELEMETRY

(U) In the case of the EATS Mod-2 upgrade, the solid line in Figure 47 shows the S/N altitude profile to be almost identical to the APATS equivalent (read APATS S/N from the right ordinate), as they both go into and emerge from telemetry blackout at about the same time. The difference of 2 dB less gain (G/T) for the EATS Mod-2 results in only 1 to 2 s earlier blackout at the upper altitude, and virtually the same blackout recovery point (about 12 km altitude). Therefore, for the MK-4 RV there would be little difference in the performance of the fully upgraded EATS and the APATS.

# UNCLASSIFIED

(U) In the case of the MK-12A (Figure 48), the fully upgraded EATS (read left ordinate) is compared with the APATS (right ordinate) for two RV impact points in the scoring pattern. Point 1 is nearest to the aircraft and produces about 10 dB higher S/N near impact than does the Point 2 impact. Blackout for the APATS is virtually nil and is very brief for the EATS and Mod-2. For reference, a curved dashed line indicates the S/N for the current ARIA 7-ft nose dish, which is slightly worse than either the EATS Mod-2 or the APATS. The conclusion for the MK-12A is therefore similar to the MK-4: a fully upgraded EATS antenna is very nearly equivalent to a postulated APATS.

## B. Impact of the Repopulation of Bigej Island (U)

### 1. Introduction (U)

#### a. Mid-Atoll Corridor (U)

(U) The Mid-Atoll Corridor under current usage at KMR (Figure 49) was established as a result of a December 1964 agreement between the U.S. Army and the government of the Trust Territory of the Pacific Islands to relocate the Marshallese living in the mid-atoll area to Ebeye Island. Because the area was required for targeting reentry vehicles for BMD and Air Force ICBM development programs, a total of 328 people was moved from 11 islands within the mid-atoll area. The parenthetical numbers in Figure 49 indicate the number of indigenous personnel moved from each island. The original agreement has been revised several times, with significant modification made in 1975. Payments to the landowners of islands within the Mid-Atoll Corridor are currently made by the Government in accordance with the terms of the FY81 KMR Interim Use Agreement.<sup>8</sup>

The 32-nmi corridor provides a relatively safe area for the terminal impact of incoming missiles from VAFB or BMD interceptors from the Kwajalein Atoll.

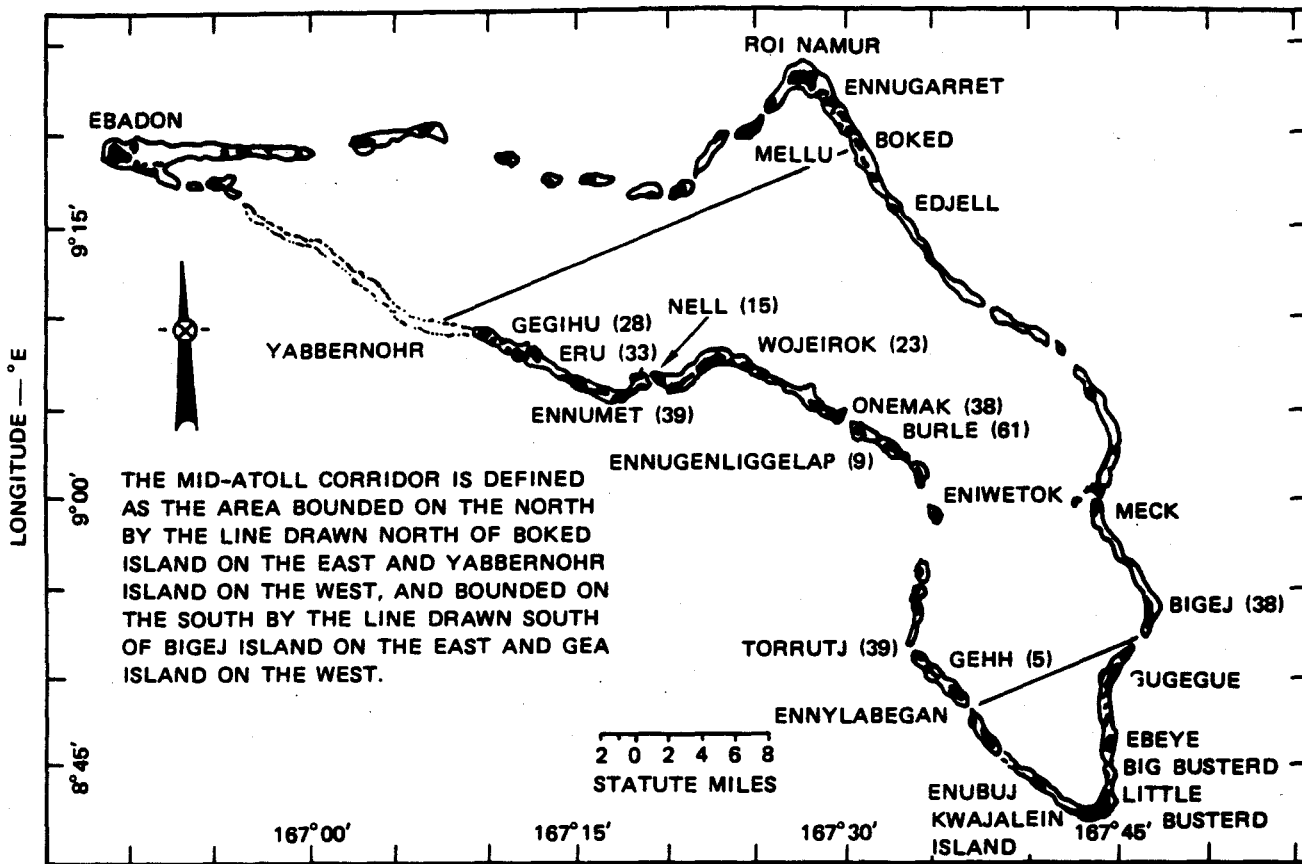

MAP I. MISSILE TEST  
~~FIGURE 49~~ (U) KMR MID-ATOLL CORRIDOR

Source: SSATSS, Nov. 1981, vol II, p. 222.

b. Previous Studies on Reoccupation of the Mid-Atoll Corridor (U)

(U) Numerous studies have been prepared on reoccupation of the Mid-Atoll Corridor. A comprehensive study was prepared in 1975 by the KMRD Safety Office, and an updated version of this study was presented in DDTE in mid-1978. In addition, the impact of repopulating Bigej Island was previously evaluated in a KMRD Safety Office study in October 1978.

# UNCLASSIFIED

## c. Interim Use Agreement (U)

(U) In the 1980-1981 Interim Use Agreement<sup>7</sup> between the United States and the Marshallese landowners, paragraph 7 indicated that ". . . a review and determination shall be made by the Deputy Under Secretary of Defense (Policy Planning) regarding relocation of the Mid-Atoll Corridor boundary north of Bigej to a position sufficient to allow safe habitation of that island at all times." OUSDRE/DDTE tasked the SSTSS chairman to perform this review in conjunction with that study under way. The chairman, in turn, tasked both WSMC and KMRD Safety Offices to analyze the potential impact to affected Air Force and Army test programs. These separate analyses were briefed to the SSTSS Ad Hoc Executive Committee on 3 February 1981 at VAFB, and the Army was tasked to consolidate the two analyses into a single briefing to be presented to DDTE. The briefing occurred on 11 March 1981, and a consolidated report was requested to document the results. X

## 2. Air Force Programs Analysis (U)

### a. Approach (U)

(U) Present policy at WSMC is to provide positive protection to population centers outside the Mid-Atoll Corridor. This means preventing dangerous debris impacts on populated islands by terminating flights to limit the instantaneous impact prediction trace to within a calculated safe abort corridor. If the tracking system is too inaccurate and the instantaneous impact prediction velocity (VIIP) too high, or if the vehicle has dangerous destruct characteristics that limit the available thrust termination options, positive protection may not be possible as a viable flight safety solution. For those cases, protection is afforded by careful planning practices and adequate hazards analyses. The hazards are evaluated for each planned launch program, and, before a launch plan is approved, constraints are established to minimize the hazards to an acceptable level relative to the national need of the program. If an impact should be on foreign soil, an international incident could result; thus, the probability of impact reflects the probability of an international X

# UNCLASSIFIED



# UNCLASSIFIED

(U)

incident. The problem is complex, and even with the existing corridor,  
certain target points may be unacceptable from a safety viewpoint. This  
study was undertaken by the WSMC Safety Office to assess the impact of  
proposed relocations upon the acceptable program hazard levels associated  
with launches from VAFB.

- (U) No overflights of populated islands.
- (U) No head-on targeting in line with populated islands without positive protection.
- (U) No stage or reentry vehicle impact dispersions encompassing populated islands.
- (U) No lagoon target points outside the approved Mid-Atoll Corridor.

MAP  
2

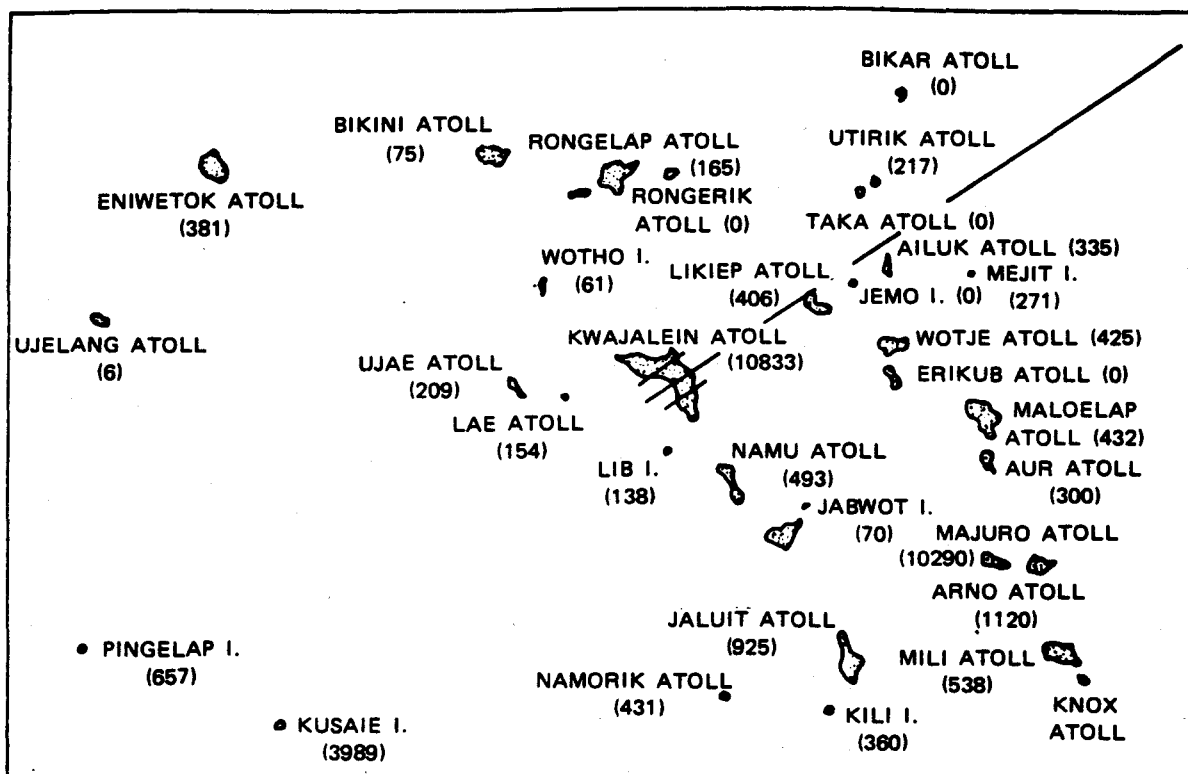

UNCLASSIFIED

MAP 2. **FIGURE 50 (U) MARSHALL ISLANDS POPULATION DENSITY AND DISTRIBUTION ASSUMPTION**

c. Methodology (U)

(U) The following cases were used to assess the penalty to launch programs as a result of island repopulation.

- (U) Abort lines were generated for MINUTEMAN III and MX programs which have positive protection abort criteria. The trajectory restrictions mentioned above were imposed.
- (U) TARGOP (target optimization) computer program runs were made for launch programs without positive protection abort criteria. The TARGOP program is a hazard analysis program that can produce hundreds of hazard analyses over a target grid. The result is a contour of the potential hazards produced with variations of the target point.

d. Air Force Programs Analysis Results (U)

Source: SS TSS, Nov. 1981, vol II, p. 225.

Ex 2

(U) For unguided rockets, test objectives are analyzed in relation to the protection of personnel and property in order to select nominal impact points. Factory performance tolerances, test history, wind conditions, etc. are also considered in determining a maximum failure range and a dispersion cone which avoids populated areas. No positive protection equipment is required, since acceptable hazard levels are engineered into the program before launch. In addition to achieving an acceptable risk, potential political incidents and facilities damage are weighed.

(U) Several classes of BMD testing are performed at Kwajalein: missile (interceptor and rocket) firings as described above; sensor tests, where target signature data and defense phenomena are collected using dedicated targets or targets of opportunity; and systems demonstrations, requiring integrated operation of multiple components. Representative types of Army programs currently being tested or planned to be tested at KMR are shown in Table 56.

Table 56

(U) ARMY PROGRAM REQUIREMENTS

Program	BMD Status	Test Area
HOE	Scheduled through 1984 for launch from Meck	Large footprint in launch area. (~ 4 nmi diameter circle)
LoAD	Scheduled for launch from Illeginni	Large footprint in launch area and will require close-in targets. (To be determined.)
ENNK	Unscheduled	Large footprint in launch area and will require close-in targets. (To be determined.)
Ground Based Optics Signature Measurements Radar MMW	On-going 1981-82 On-Going	Requires both nearby and a variety of impact areas. For targets of opportunity.
ISMR	Unscheduled (anticipated 1982-85)	Variable aspect angles and close-in targets (~ 0-30°)
Low-cost BMD target vehicles	Unscheduled (study) (1983?)	Requires large impact area. (To be determined.)
SRAM	<u>Unscheduled (anticipated)</u>	<u>Requires irregular area which is close to tracking radar</u>

UNCLASSIFIED

229

UNCLASSIFIED

UNCLASSIFIED

# UNCLASSIFIED

## b. Launch Site Geometries (U)

(U) Meck Island, the principal guided interceptor launch facility at KMR, has the capability to launch high performance (SPRINT-like) and large (SPARTAN-like) missiles. Support facilities are extensive. Meck is 9.5 nmi south of the Mid-Atoll Corridor boundary and only 6.5 nmi north of Bigej Island (Figure 53).

Ex 2

## FIGURE 53 (U) BIGEJ REPOPULATION CONSIDERATIONS

(U) Roi-Namur is the principal unguided rocket launch facility having trainable launchers and related support facilities. Roi-Namur is only 4.5 nmi north of the Mid-Atoll Corridor boundary and only 2.5 nmi to the island of Ennubirr, which is populated with about 175 Marshallese (Figure 49).

(U) Illeginni Island, which has been used for both SPRINT and SPARTAN launches, is now deactivated. Although some support facilities exist, major renovations and modifications would be necessary to make it reusable.

# UNCLASSIFIED

(U) Small (meteorological) rockets have been launched from Kwajalein, Meck, Omelek, and Roi-Namur.

2

x

# UNCLASSIFIED

(U)

launch facility. Finally, a cluster of the best signature measurement sensors in the free world is on Roi-Namur. This one-of-a-kind capability could not be replaced and should not be subjected to significant risk.

(U) The small rocket launcher locations all suffer from the lack of adequate support facilities and launcher capability for the interceptors. The Meck and Roi-Namur sites are doubtful as meaningful alternatives. Omelek has access only by helicopter and a lack of support communications and facilities.

... of reconstructing the facilities

✓ 5

x

<u>Task Number</u>		<u>Responsible Person/Agency</u>
A18		K. George/WSMC
A19		Smith/KMRD Land/WSMC
A22	(U) GPS/SMILS design, ROM costs	K. George/WSMC Strietzel/KMRD Miller/ESMC SRI
A24	(U) DOT maintenance approach or alternate scoring	C. Miller/ESMC Carr/PMTIC
A25	(U) Develop rationale for program/option assessment	Land/Ship/Aircraft/ Subgroups
A27	(U) Cost to operate/maintain EATS P3 aircraft	Cdr. McConnel/PMTIC
A28	(U) Midcourse and terminal area operations cost	
	KMR - Present	Davis/KMR
	ESMC - ASC, Midcourse	Herrburger/ESMC
	WSMC - Concepts	George/WSMC
	ARIA - to 1999	SRI

B. Meeting of 21-25 April 1980 (U)

- Minutes; 21-25 April 1980; by Col. Ed Miller, ESMC-RO
- Task Assignments:

<u>Task Number</u>	<u>Topic</u>	<u>Responsible Person/Agency</u>
B1	(U) Vandenberg joint-use as Atlantic TASS for TRIDENT and Pacific support in lieu of USNS Arnold and USNS Wheeling	Ships Subgroup C. Miller/WSMC
B2	(U) Alternative aircraft potential compared with ARIA for ALCM/GLCM support	A/C Subgroup L/C Hopkins/4950
B3	(U) Range safety constraints and trajectory for TRIDENT-to-KMR	PMTIC and KMR Safety
B5	(U) Comparability of cost data	Blackwell/SRI
B6	(U) ABRES JI/Hawaii launch head cost/schedule (consider program and range requirements)	Lee/BMO
B7	(U) MM II, III/Hawaii launch head cost/schedule (consider program and range requirements)	BMO/WSMC/ SAC/WSMC/George



<u>Task Number</u>	<u>Topic</u>	<u>Responsible Person/Agency</u>
B9	(U) USNS Vandenberg UHF Radar to Antigua	Lochman/ESMC
B11	(U) Better definition of assumptions made on Pacific SMILS requirements (Task 4 from 17 March meeting) (# size array/location) (aircraft/ships)	George/WSMC Carr/PMTC/Hopkins to C. Miller (Completed)
B12	(U) Total workload chart: for ships and options to meet workload/deficiencies in capability	Ships Subgroup C. Miller/ESMC
B13	(U) Total workload chart: for aircraft and options to meet workload deficiencies in capabilities (P-3/ARIA/other)	A/C Subgroup A/C Hopkins/4950th
B17	(U) Advanced program requirements (projections) MARV	ATC/BMD DARPA/DARCOM Sys Comm SPO AF Chief SC by Chairman/Deputies
B18	(U) Naval capability to vary Pacific launch points to points being considered. Minimize terminal areas (ROMS)	SP 25/PMTC
B19	(U) Operational scenario for Pacific SMILS operation (status of resources acquisition)	George/WSMC PMTC

C. Meeting of 4-5 June 1980 at Pentagon, WDC (U)

1. Minutes: 4-5 June 1980; by Dr. James A. Means
2. Task Assignments:

<u>Task Number</u>	<u>Topic</u>	<u>Responsible Person/Agency</u>
C1a	(U) Can GPS-SMILS be done solely by ARIA aircraft?	SRI
C1b	(U) Can SADOTS impacts be read out by ARIA?	SRI
C1c	(U) Can "Wheeling II" be deferred this year?	SRI and Ad Hoc/Navy
C1d		BMD

# UNCLASSIFIED

Task Number	Topic	Responsible Person/Agency
Cle	(U) Analyze the ability of EATS to do ARIA role (and vice versa), a key area to look at is EATS supporting cruise missile testing	SRI
Clf	(U) Impact of post October actions at KMR on testing	BMD

D. Meeting of 15-17 July 1980 at VAFB (U)

1. Minutes: 15-17 July 1980; by Dr. James A. Means
2. Task Assignments:

Task Number	Topic	Responsible Person/Agency
D1	(U) Review of ship workload with Navy to further define TRIDENT requirements	ESMC/RSO/SRI
D2	(U) Refine aircraft workloads to include cruise missile, NASA, Shuttle requirements	4950th
D3	(U) Develop white papers on EATS vs ARIA capability and ARIA BOA scoring capability	SRI
D4	(U) Furnish SRI information on P-3C TLM capability to supplement ARIA	WSMC/RO
D5	(U) Report on status of NAVOCEANO support for DOT implantation/maintenance in the Pacific for TRIDENT and MX through 1985	PMTIC and WSMC/RO
D6	(U) Continue development of KMR move plan to include transitional plan and impact on programs	B MDSC-RS
D7	(U) Resolve impact points at KMRN and resolve safety issues for KMRN	KMRD, PMTC and WSMC
D8	(U) Review of BMDSC paper on elimination of Ascension as alternative to KMR and comments to SRI/BMDSC-RS	Chairman, Deputy Chairman and WSMC/XR
D9	(U) Review of SRI summarized requirements to answer questions and assure accuracy. Results to SRI	Chairman, Deputy Chairman and WSMC/XR
D10	(U) Present alternative method of DOT implant and scoring at KMRN in detail, with ROM costs	KMRD

<u>Task Number</u>	<u>Topic</u>	<u>Responsible Person/Agency</u>
D11	(U) Furnish MSC with information on Pacific DOT implant/maintenance for inquiry on commercial interest/capability	ESMC/RSO
D12	(U) Plan for MX support at KMRN	WSMC/RO

E. Meeting of 12-14 August 1980 at PMTC (U)

1. Minutes: 12-14 August 1980; by Dr. James A. Means
2. Task Assignments:

<u>Task Number</u>	<u>Topic</u>	<u>Responsible Person/Agency</u>
E1	(U) Status report on Pacific DOT implantation	WSMC/PMTC
E2	(U) Position paper on 4 telemetry antennas support on ship for BOA (cost/schedule/application)	ESMC
E3	(C)	SRI
E4	(C)	BMDSC
E5	(C)	BMDSC
E6	(U) MX/OT requirement for Pierce Point	WSMC
E7	(C)	WSMC/BMDSC
E13	(U) Develop estimate of potential ARIA cost savings from development of telemetry pod on chase aircraft for ALCM support	SRI
E14	(U) Comments to SAMTO/CA on outlines: A. Final Report B. Briefing	All
E15	(C)	WSMC

F. Meeting of 24 October 1980 at BMDSCOM (U)

1. Minutes: 24 October 1980; by Dr. James A. Means
2. Task Assignments:

<u>Task Number</u>	<u>Topic</u>	<u>Responsible Person/Agency</u>
F1 (E13)	(U) Develop estimate of potential ARIA cost savings from development of telemetry pod on chase aircraft for ALCM support	URIA Study Group w/SRI
F2	(U) Evaluation of URIA (to include ARIA vs P-3 for strategic support missions, ultimate VX-1 relief in the Atlantic)	URIA Study Group
F3	(U) MINUTEMAN II/III BOA terminal support statement	Dr. Means
F4	(U) TITAN II booster for ABRES	VAFB and BMO
F5	(U) Recommendation/rationale on near-term action to develop	Dr. Smith
F6	(C)	Ad Hoc (C&C) WSMC (Response)
F7	(C) i c r	Ad Hoc with WSMC (George) and SRI
F8	(U) Status briefing from MX/TRIDENT test target working group on consolidation of BOAs	SAMTO (Hassen)
F9	(U) Contract modification, extension for URIA/telemetry antenna	B. Davis with SRI/ Hassen
F10	(U) ISA assessment of C-7A transit issue	Smith/ISA
F11	(U) Contracted ship for DOT implant/maintenance	Miller/ESMC
F12	(U) Ships alternative White Paper	Miller/ESMC

G. Meeting of 3-5 February 1981 at WSMC (U)

1. Minutes: 3-5 February 1981; by Dr. James A. Means
2. Task Assignments:

# UNCLASSIFIED

Task Number	Topic	Responsible Person/Agency
G1	(U) ALCM TM pod cost savings	SRI/Hassan
G2	(U) SLTA economic justification	SRI
G3	(U) Micronesia briefing	Dr. Means
G4	(U) Bigej repopulation	Dr. Smith and WSMC/SE
G5	(U) Final report JTWG	BMO
G6	(U) Navy decision on P-3A source	Prestipino
G7	(U) DOT implant notes (verbal)	Hassan
G8	(U) Pacific communications with service representative	Dr. Means
G9	(U) C-7A TASA offloaded	KMRD
G10	(U) Redefine telemetry requirements for MX/TRIDENT during reentry	BMO/SP-25
G11	(U) Test of C-7A HF link on IRAN missions	KMRD

H. Meeting of 21-22 April 1981 at BMDSCOM (U)

1. Minutes: 21-22 April 1981; by Dr. James A. Means
2. Task Assignments:

Task Number	Topic	Responsible Person/Agency
H1	(U) Impact of SLTA on APAT/EATS(U) Nos. (fleet size) (others as required)	SRI
H2	(U) JTWG reports	BMO/Herzog
H3	(U) Consider Option VII (combination of III and IV)	URIA SG
H4	(U) Brief CINCPAC on Pacific support scenario	Means/Hassan
H5	(U) Attend Raytheon Goleta briefing on EATS upgraded antenna	Exec. Committee

III GENERAL BIBLIOGRAPHY MATERIAL (Not Archived) (U)

Item Number	Title	Corporate Author	Date
1	(U) "Supplemental Land-Based Terminal Area Site Survey Report" (U) (CONFIDENTIAL)	WSMC VAFB, California	June 1981
2	(U) "Advanced Range Instrumentation Ship Modernization Plan" (SECRET)	AFESMC, Patrick AFB, Florida	December 1976

# UNCLASSIFIED

Item Number	Title	Corporate Author	Date
3	(U) "Instrumented Range Ships Study" (U) (SECRET)	MITRE	November 1978
4	(U) "Airborne/Shipborne Radar Study" Vol. I, Exec. Survey (COBRA JUDY) (SECRET)	AFETR	February 1974
5	(U) Proposal for COBRA JUDY (SECRET)	Raytheon, Wayland, Massachusetts	June 1973
6	(U) "Analysis of Relocation of Kwajalein" Vol. I, II, III	BMDSCOM/KMRD	June 1979 X
7	(U) "WSMC Statement of Capability for MX Flight Tests"	WSMC	12 May 1980
8	(U) "Advanced Range Instrumentation Ships (ARIS) Modernization Plan" (U) (SECRET)	Air Force Eastern Test Range, Patrick AFB, Florida	17 December 1976
	(U) Station Manual for USNS Wheeling T-AGM-8 (Official Use Only)	Dept. of the Navy, Pacific Missile Test Center	1 January 1980
9	(U) "Airborne Alternatives for RV Impact Scoring in the Broad Ocean"	SRI International	30 October 1978
10	(U) "Flight Program Requirements Document--Shuttle-OFT-Flight PRD"	NASA	May 1979
11	(U) "Far-Term Mobile Instrumentation Study" Vol. I, Final Report	SRI International	February 1978
12	(U) "Technical and Economic Feasibility of Airborne and Satellite Instrumentation Systems to Augment National Test and Evaluation Resources," Final Report	SRI International	July 1979
13	(U) "GPS-SMILS Concept Definition"	SRI International	March 1980
14	(U) "Airborne Alternatives for RV Impact Scoring in the Broad Ocean"	SRI International	30 October 1978
15	(U) "Proposal for COBRA JUDY Airborne/Shipborne Radar Study" (U)	Raytheon Company	6 June 1973
16	(U) ARIS Orientation Manual	RCA International	January 1977
17	(U) ARIS Handbook for Data Users	RCA International	April 1979
18	(U) Station Manual USNS Wheeling T-AGM-8	Dynallectron Corporation	31 July 1980

# UNCLASSIFIED

# UNCLASSIFIED

Item Number	Title	Corporate Author	Date
19	(U) Range Instrumentation Ship Technical Systems Evaluation	Pacific Missile Test Center, Pt. Magu	March 1980
20	(U) Advanced Range Instrumentation Aircraft Operational Capability Report OCR	4950th Test Wing Wright-Patterson AFB	1 October 1976
21	(U) "ARIA Support for Boeing-AGM-86-DTIK ALCM"	4950th Test Wing Wright-Patterson AFB	15 November 1980
22	(U) "ARIA Support for Boeing-AGM-86-DOE ALCM"	4950th Test Wing Wright-Patterson AFB	15 November 1980
23	(U) ARIA Support for Boeing-AGM-86-NTIK ALCM"	4950th Test Wing Wright-Patterson AFB	15 November 1980
24	(U) "Interface Control Weight and Balance Summary EATS P-3A Aircraft"	PMTC	April 1979
25	(U) "Caribou TASA Study (C-7A Terminal Area Support Aircraft)"	Ballistic Missile Defense System Command	23 October 1980
26	(U) "C-7A TASA (Terminal Area Support Aircraft) Design Freeze"	Ballistic Missile Defense System Command	21 April 1981
27	(U) "Portable Impact Location and Tracking" (PILAT) System Study	Kentron International	27 April 1979
28	(U) "GPS-SMILS Concept Definition"	SRI International	March 1980
29	(U) "Airborne Alternatives for RV Impact Scoring in the Broad Ocean"	SRI International	30 October 1978
30	(U) "Strategic Systems Test Support Study Data"	Headquarters Eastern Space & Missile Center (AFSC) Patrick AFB	3 March 1980
31	(U) "Strategic Systems Test Support Study"	BMO/MNNXC, MNNXT, AFTEC	18 April 1980
32	(U) "Terminal Area Telemetry Support Estimates for SSTSS"	Lockheed Missile	25 August 1980
33	(U) "A Missile Impact Location System Employing <u>Splash Activated Deep Ocean Transponders: Description &amp; Technical Analysis</u> "	Naval Underwater Systems Center	1 April 1980
34	(U) "Pacific Range Support Alternatives"	Pacific Missile Test Center	August 1980

# UNCLASSIFIED

## IV GENERAL CORRESPONDENCE (Archived) (U)

<u>Item</u>	<u>Topic</u>	<u>Date</u>
1	(U) Letter from G. P. Dennen USDRE to Asst. Secretary of Army	October 1979
2	(U) Memo from Charlie Miller (ESMC to ad hoc) on comments to ANSER ship study	23 May 1980
3	(U) Memo (unofficial) from R. Herzog to SSTSS ad hoc group, on MM launch facility costs at alternate launch sites	1 June 1980
4	(U) Memo PAFB facilities contractor (Pan-Am) on MM launch site costs at ESMC	7 May 1980
5	(U) Memo--Lt. R. Hassan ESMC-XR to SSTSS SMILS support	15 May 1980
6	(U) Memo--MRTFC to Tri-Service; original SSTSS tasking letter	October 1980
7	(U) TWX: HQSAC to ESMC/PAFB, relocation of MM test launch facilities	14 May 1980
8	(U) Letter from Mr. R. T. Herzog to Dr. J. A. Means	13 August 1980
9	(U) Letter and attachments from Mr. R. T. Herzog to Dr. J. A. Means	21 August 1980
10	(U) Letter to BMDSCOM/RS (Dr. C. D. Smith), NAVAIRSYSCOM/AIR-610 (Mr. V. J. Prestipino) and SRI International (Mr. E. Blackwell), and enclosures	2 March 1981
11	(U) Letter from R. B. Pickett to Mr. K. George	March 1981



# UNCLASSIFIED

## REFERENCES (U)

1. "The Impact of the Repopulation of Bigej Island," Western Space and Missile Center Safety Directorate, Vandenberg Air Force Base, and Kwajalein Missile Range Directorate Safety Office, Huntsville, Alabama (3 April 1981). ✂
2. J. F. Cline and E. G. Blackwell, "EATS and APATS Telemetry Antenna Performance Comparison in a Ballistic Missile Terminal Area Support Role," Final Task Report, Contract DASG60-80-C-0069, SRI Project No. 1715, SRI International, Menlo Park, California (June 1981), UNCLASSIFIED.
3. E. G. Blackwell et al., "Universal Range Instrumentation Aircraft (URIA) Study," Final Task Report, Contract DASG60-80-C-0069), SRI Project No. 1715, SRI International, Menlo Park, California (June 1981), UNCLASSIFIED.
4. "Caribou TASA Study," BMDSCOM-R (23 October 1980).
5. "C-7A TASA Status Report," BMDSCOM-R (4 February 1981).
6. "C-7A TASA Design Freeze," BMDSCOM-R (21 April 1981).
7. "Supplemental Land-Based Terminal Area (SLTA) (U)," Site Survey Report, Western Space and Missile Center (May-June 1981), CONFIDENTIAL. C. et
8. Interim Use Agreement between the Government of the Marshall Islands and the United States concerning the Kwajalein Missile Range; copy on file at BMDSCOM-R Huntsville, Alabama.

BIBLIOGRAPHY (U)

I SSTSS BRIEFINGS (Archived) (U)

<u>Date</u>	<u>Title</u>	<u>Presented To</u>
June 1980	Phase I	MRTFC
September 1980	Phase II	MRTFC
July 1981	Final Brief	MRTFC
February 1981	Pacific Affairs	DoD/ISA; Dept. of State, DACAF/CINCDAC
April 1981	Bigej Repopulation	OUSDRE/DDTE

II SSTSS WORKING SESSION MATERIALS (Archived) (U)

A. Meeting of 17-21 March 1980 at VAFB (U)

- Minutes: 17-21 March 1980; by Col. Edward Miller, ESMC (ret) (709 pages)
- Task Assignments:

<u>Task Number</u>	<u>Topic</u>	<u>Responsible Person/Agency</u>
A2		K. George/WSMC, et al.
A4	(U) Pacific SMILS design/ROM cost/schedule for BOA and Extended Range MX and TRIDENT (Invest \$, Opn \$, Impl Plan) resource acquisition and availability	K. George/WSMC Carr/PMTC
A5a	(U) KMRN applicability to TRIDENT	Rasmussen/SP25, Strietzel/BMD
A5b	(U) KMRN applicability to MINUTEMAN III	Capt Schankel/SAC Strietzel/BMD Cherry/WSMC
A14	(U) Requirements interpretation, completion and integration, and documentation	SRI ad hoc
A15	(U) Ascension Island option definition/ROM cost/schedule and safety/geopolitical issues, resource acquisition and availability (Term Signature for ABRES)	Curt Lochman/ESMC (Integrate Term Instrumentation with Requirements)
A16	(U) Define ship's feasibility and capability for terminal area in the Mobile Ship Concept and Design/ROM cost/schedule for doing	Miller/ESMC Cdr. Hollinger/PMTC SRI
A17		Smith/KMRD Lane/WSMC SRI