

1313

COMMANDER IN CHIEF U.S. PACIFIC COMMAND HISTORY



VOLUME II (U)

1994

*Prepared by the Command History Division
Office of the Joint Secretary
Headquarters USCINCPAC*

CAMP H.M. SMITH, HAWAII 96861-4028
1996

DERIVED FROM: MULTIPLE SOURCES
DECLASSIFY ON: OADR
DATE OF SOURCE: 15 FEB 1995

NOT RELEASABLE TO FOREIGN
NATIONALS
WARNING NOTICE
Intelligence Sources and Methods Involved

copy 1 of 52 COPY 52 OF 53 COPIES

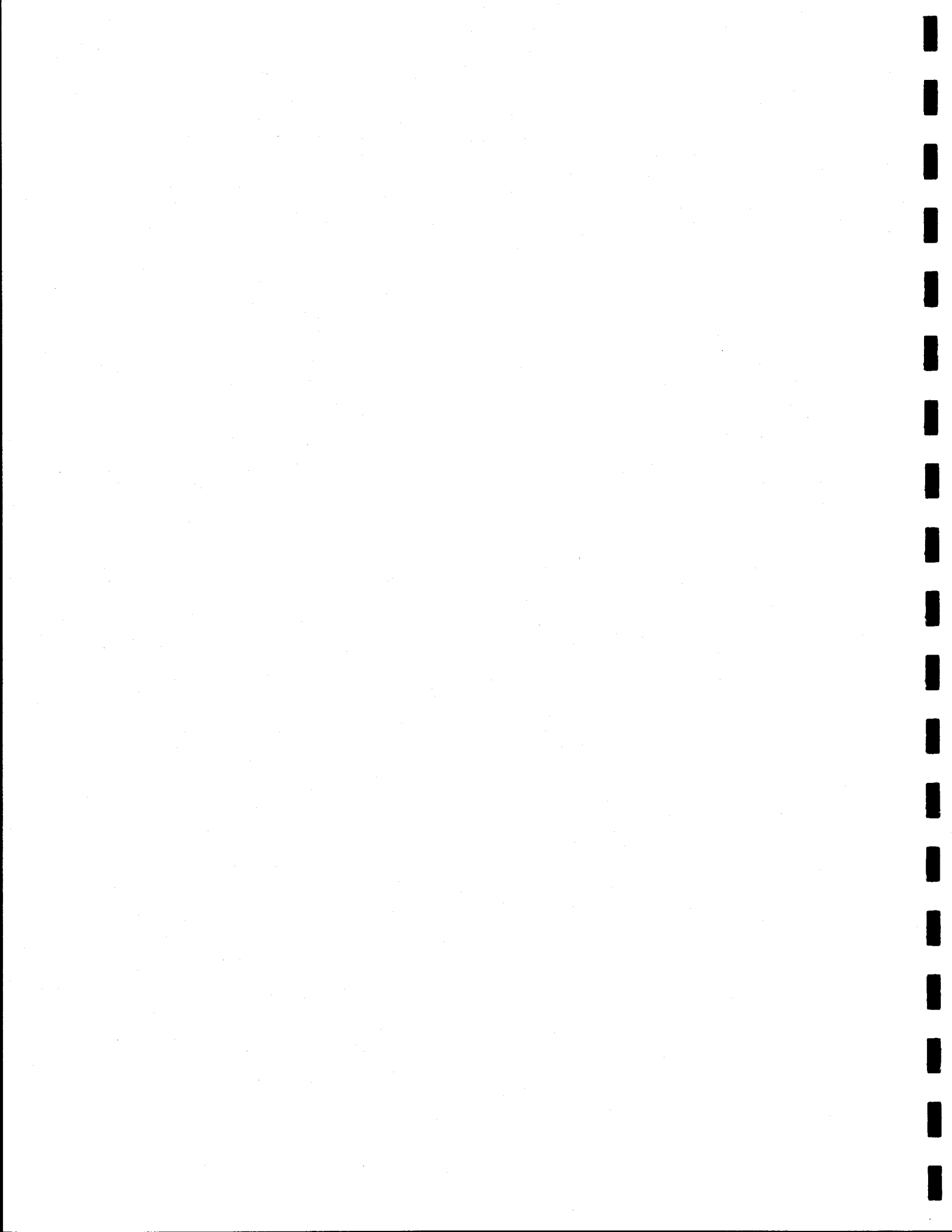

~~SECRET~~

**COMMANDER IN CHIEF
U.S. PACIFIC COMMAND HISTORY**



VOLUME II (U)

1994

*Prepared by the Command History Division
Office of the Joint Secretary
Headquarters USCINCPAC*

CAMP H.M. SMITH, HAWAII 96861-4028

1996

Derived From: Multiple Sources
Declassify On: OADR
Date of Source: 15 Feb 1995

~~SECRET~~

SECRET

THIS PAGE INTENTIONALLY LEFT BLANK

~~**SECRET**~~

~~SECRET~~

TABLE OF CONTENTS (U)¹

VOLUME II

	<u>Page</u>
CHAPTER VI--COMMAND AND CONTROL AND COMMUNICATIONS SYSTEMS	
SECTION I--TELECOMMUNICATIONS MANAGEMENT	
J6 Reorganization	299
Exercise TANDEM THRUST	299
Exercise COBRA GOLD 94	300
Exercise TEMPO BRAVE 94-1	300
Joint Crisis Management Capability-1 Hatchmount Suite	301
SECTION II--C3 SYSTEMS AND INTEGRATION	
Pacific Video Teleconferencing Network	303
Joint Worldwide Intelligence Communications System for Korea	303
SCIS/PDS Installation	304
Contingency Theater Automated Planning System	304
Japan Reconfigurations and Digitization	305
Defense Red Switch Telephone Network	306
Transfer of AN/TSC-122s to USPACOM	306
High Frequency Radio Network Consolidations	306
SECTION III--COMBINED INTEROPERABILITY	
Operations/Intelligence Multi-Level Security Interface Installation	309
Secure Network Server Installation at USCINCPAC	309
Combined Interoperability Program	310
Australia CCIBs	310
Republic of Korea CCIBs	311
Singapore CCIB	311
Thailand CCIB	312
Japan CIP Negotiations	313
CIP Introduction to the Armed Forces of the Philippines	314
Malaysia CIP Brief	314
USCINCPAC Instruction for OTAR and OTAT	315
USPACOM INFOSEC Conference	315
Spectrum Management Conference	315
Pacific Senior Communicators Meeting	316
SECTION IV--ADP, WWMCCS, AND BASE COMMUNICATIONS	
Automated Message Handling System	317
USPACOM C2 ADP Plans and Requirements Conference	318
Unofficial Telephone Service	318
CHAPTER VII--OTHER SUPPORTING ACTIVITIES	

¹ Individual entries are unclassified. See Letter of Promulgation.

~~SECRET~~

~~SECRET~~

SECTION I--OFFICIAL ACTIVITIES OF THE COMMANDER IN CHIEF	325
Trips and Associated Activities	325
Distinguished Visitors and Local Events	349
SECTION II--INSPECTOR GENERAL ACTIVITIES	365
Command and Control Inspections	365
US Forces Korea	365
US Forces Japan	365
Commander, Alaskan Command	366
Commander in Chief, US Pacific Fleet	366
Commanding General, US Army Pacific	367
Commander, Pacific Air Forces	367
Performance Evaluation Group Reports	368
India	368
Thailand	369
Singapore	370
Nepal	370
SECTION III--COMPTROLLER ACTIVITIES	373
USCINCPAC FY 94 Operating Budget	373
Military Assistance Executive/Foreign Military Sales Trust Funds	373
T20 Security Assistance Organization Expenses	374
Official Representation Funds	374
MAP Representation Allowance	375
Emergency and Extraordinary Expenses Funds	375
FY94 Funding Adjustment	375
Impact of Budget Adjustments	376
SECTION IV--PUBLIC AFFAIRS	377
Media Operations	377
Community Relations	380
SECTION V--LEGAL AFFAIRS	385
Homosexual Policy	385
Terms of Reference for US-Philippines Legal Affairs Committee	386
Russian-American Seminar on the Law of the Sea	386
SECTION VI--MEDICAL ACTIVITIES	387
Biosafety Level 3 Laboratory	387
Naval Hospital Okinawa	388
Elmendorf Hospital	389
Smoke Free Workplace	390
Family Advocacy	390
Alaska	390
Japan and Korea	391
Telemedicine at Tripler Army Medical Hospital	393
Biennial Medical Conference	394

~~SECRET~~

~~SECRET~~

CHAPTER VIII--SELECTED CHRONOLOGY 1994	399
APPENDIX I----Command Status	413
APPENDIX II---Logistics and Security Assistance	441
APPENDIX III--Command and Control and Communications Systems	453
APPENDIX IV---Country Summaries	459
Glossary	493
Index	507
Staff Organization Directory	Inside back cover

SECRET

~~SECRET~~

THIS PAGE INTENTIONALLY LEFT BLANK

~~SECRET~~

UNCLASSIFIED

CHAPTER VI(U)

COMMAND AND CONTROL AND COMMUNICATIONS SYSTEMS(U)

SECTION I--TELECOMMUNICATIONS MANAGEMENT(U)

J6 Reorganization(U)

(U) Under the direction of BG Gerard P. Brohm, Director for Command and Control and Communications Systems, J6 was reorganized early in 1994 to better align to meet mission requirements. The Systems Integration Division (J61) was eliminated as a separate entity and the functions were merged into a new C3 Systems and Integration Division (J64). This decreased the number of divisions in J6 from five to four. Most of the J61 functions became part of the C3 Systems Integration Branch within J4. Overall the number of branches was also decreased from fourteen to eight.¹

Exercise TANDEM THRUST 95(U)

(U) Exercise TANDEM THRUST 95 (TT95), 15 November through 15 December 1994 (first quarter FY 95) was a short-warning, limited-power-projection field training exercise (FTX) that exercised USPACOM's two-tier concept of operations (CONOPS) with Commander SEVENTH FLEET, aboard USS BLUE RIDGE operating as the Commander Joint Task Force (CJTF). A major exercise goal was to conduct Joint Force Air Component Command (JFACC) operations afloat, with the USS KITTY HAWK as the JFACC. A well planned command, control, communications, and computers, and intelligence (C4I) suite ensured that the Contingency Theater Automated Planning System (CTAPS)² supported the JFACC afloat concept exceptionally well. In addition, other systems, such as the Theater Command and Control System (TCCS), Officer in Tactical Command Information Exchange System (OTCIXS), Plain Old Telephone System (POTS), Standard Telecommunications (STEL), Joint Deployable Intelligence Support System (JDISS), Allied Command

UNCLASSIFIED

UNCLASSIFIED

Information and Exchange System (ACIXS), and video teleconferencing (VTC) also supported the CJTF and component commanders in an outstanding manner. TT95 C4I worked for the JTF rather than the JTF working for C4I.³

Exercise COBRA GOLD 94(U)

(U) Exercise COBRA GOLD '94 (CG94) was an annual US and Thailand joint and combined command post and field training exercise. The communications plan for CG94 was the "most extensive, intricate and successful communications plan ever implemented by US forces deployed in Thailand." The communications system was installed and activated during the period 27 April through 4 May 1994. The overall system was composed of 11 deployed Ground Mobile Forces (GMF) terminals with interfaces into two Gateway ground stations and two garrison "reachback" terminations, 12 major tactical automated telephone switching systems, six major AUTODIN terminations, ten tactical single channel UHF radio satellite networks, and numerous HF, VHF, UHF, and SHF terrestrial radio networks. Overall performance was considered highly successful.⁴

Exercise TEMPO BRAVE 94-1(U)

(U) A J6 representative deployed as a member of the Deployable Joint Task Force Augmentation Cell (DJTFAC) to the USS BLUE RIDGE, SEVENTH FLEET command ship, during the period 7-21 April 1994 to participate in Exercise TEMPO BRAVE 94-1 (TB94-1) with the COMSEVENTHFLT staff who acted as the CJTF for the exercise. The Theater Command and Control System was tested extensively for the first time during this exercise. With few exceptions, communications were quite successful.⁵

UNCLASSIFIED

UNCLASSIFIED

Joint Crisis Management Capability-1 Hatchmount Suite(U)

(U) On 27 August 1994, five J6 personnel assisted Johnston Island operations after Hurricane JOHN swept through the island. A C-130 UHF tactical satellite (TACSAT) hatchmount suite of equipment, including radio, amplifier, power supply, cabling and antenna, was provided. USARPAC provided cryptographic equipment. Per request, communications provided were limited to voice communications only. Operations began on liftoff of the aircraft and operated satisfactorily throughout the weekend mission. This was the first use of USCINCPAC's Joint Crisis Management Capability-1 (JCMC-1) hatchmount suite since it was acquired during the summer of 1994.⁶

UNCLASSIFIED

UNCLASSIFIED

THIS PAGE INTENTIONALLY LEFT BLANK

UNCLASSIFIED

UNCLASSIFIED

SECTION II—C3 SYSTEMS AND INTEGRATION(U)

Pacific Video Teleconferencing Network(U)

(U) Joint Staff approved USCINCPAC's CINC Initiative Fund (CIF) proposal to integrate the theater's collateral video teleconferencing networks and to provide basic, digitally interoperable, secret-high VTC service between USCINCPAC, on-island components, Tier 1 CJTFs, subordinate unified commands, and CONUS-based commands. Joint Staff and Defense Information Systems Agency expressed a keen interest in this project because it would be the benchmark for DOD-wide VTC standardization. Known as the Pacific Video Teleconferencing (PACVTC) Network, the \$1,470,000 proposal was based on selected upgrades to the Pacific Air Force Numbered Air Force VTC Network and Navy's Video Teleconferencing Information Exchange System (VIXS). The initial design work was started in May 1994. The network was to be operational by March 1995.⁷

Joint Worldwide Intelligence Communications System for Korea(U)

(U) The C3 Systems and Integration Branch (J64) coordinated the installation of a T1 (1.544 MBPS) Joint Worldwide Intelligence Communications System (JWICS) circuit over the Defense Satellite Communications System (DSCS) from the Pentagon to Korea. This provided the National Intelligence Support Team (NIST) a SCI Video Teleconference and high SCI data rate capability. The DSCS path was temporary and would move to a commercial leased circuit when Army funds were available. In August 1994, the JWICS Program Management Office (PMO) extended the JWICS VTC capability to Osan AB and Camp Tango, Korea. J6 assisted in the circuit reconfiguration.⁸

UNCLASSIFIED

~~SECRET~~

SCIS/PDS Installation(U)

(U) Air Force Space Command installed the Survivable Communications Integration System (SCIS) Fallback/Processing and Display Subsystem (PDS) in the USCINCPAC Command Center in early 1994. SCIS/PDS is the standard processing and display system to present formatted Integrated Tactical Warning and Attack Assessment information to the CINC and National Command Authorities. Air Force Operational Test and Evaluation Center (AFOTEC) was conducting formal testing before the system became operational. In the meantime, the system was used for training and developing operating procedures.⁹

Contingency Theater Automated Planning System(U)

(S) During Exercise ULCHI FOCUS LENS 94, as well as the deployment to Haiti, significant problems were experienced disseminating the Integrated Tasking Order (ITO) over the Automatic Digital Network (AUTODIN). The length of the ITO, the number of addressees requiring the ITO, and the limited capacity of AUTODIN effectively shut down AUTODIN for an unacceptable length of time when the ITO was transmitted. Since the ITO was transmitted over several systems (Contingency Theater Automated Planning System (CTAPS); Korean Combat Support System (KCCS); Demand Assigned Multiple Access (DAMA); Tactical Army Command, Control and Information Management System (TACCIMS); and AUTODIN) and some users were receiving the ITO over other systems in addition to AUTODIN, efforts were being made to decrease the number of addressees requiring the ITO as well as reducing the number of addressees receiving the ITO over AUTODIN. Additionally, instructions were given to assure compliance with Joint Army, Navy, Air Force Pacific Publication 128 (JANAP 128), AUTODIN Operating Procedures, which would significantly reduce the size of most ITOs. AUTODIN was used regularly in peacetime, and inability to communicate over AUTODIN had the potential to

~~SECRET~~

~~SECRET~~

create a huge problem during a contingency. It was very important this concern be addressed and the problem resolved through cooperation from the ITO addressees.¹⁰

(U) CTAPS Version 5.1 (V5.1) was installed in the USCINCPAC theater as of the end of 1994. Initial installations were to the PACAF Computer Support Squadron, Naval Research and Development Center, and Marine Corps Tactical System Support Activity (MCTSSA), with follow-on installations at key USAF and USMC sites as well as deploying aircraft carriers. PACAF and MCTSSA did extensive testing and systems integration with V5.1 to address some theater-unique aspects and configurations of the system, especially in Korea.¹¹

Japan Reconfiguration and Digitization(U)

(U) Japan Reconfiguration and Digitization (JRD) was long term program to upgrade and reconfigure DOD communications systems in Japan, particularly in the Kanto Plain. Phase III included laying a submarine fiber optic cable (SFOC) between Gesashi, Okinawa, and Sasebo, Japan to improve service for commands on Okinawa. In February 1993, the SFOC was damaged by ships anchoring in the area. Contract negotiations with the local Japanese fishing union to allow repair of cable caused delays in repairs. An agreement was finally reached and Defense Information Systems Agency (DISA) contracted with Cable and Wireless, Ltd., for the Cable Ship (C.S.) ENTERPRISE to begin cable repairs on two suspected breaks beginning 1 February 1994. During the process of repairing the first two breaks, a third break (the fourth since the original cable installation) was detected. COMUSJAPAN negotiated with Japanese agencies concerned to extend the permits to complete repairs. On 14 March 1994, all repairs were complete and testing began prior to putting SFOC circuits back into service. The SFOC became fully operational the following quarter.¹²

UNCLASSIFIED

Defense Red Switch Telephone Network(U)

(U) In 1994, Jont Staff and DISA made the decision to standardize the Defense Red Switch Network (DRSN) through installation of ElectroSpace Systems Incorporated (ESI) red switch equipment. At Camp Smith, Hawaii, USCINCPAC had to replace its GTE switch with ESI equipment. The Red Switch allows users to make high quality secure calls (i.e., suitable for voice recognition) and take and make calls to the CINC's Trip Information System VHF TACSAT radios from their offices rather than going to a Special Intelligence Communications (SPINTCOM) terminal. The ESI Red Switch installation at USCINCPAC began on 21 June 1994, and cutover to interim service from the Hickam AFB Red Switch occurred on 6 September. The new HQ USCINCPAC Red Switch was officially accepted on 13 December 1994 with the signing of the Test and Acceptance Report (TAR). The Air Force Information Support Agency granted an interim TS-SCI accreditation through 5 September 1995. Final accreditation was pending the receipt of the government test results.¹³

Transfer of AN/TSC-122s to USPACOM(U)

(U) The Joint Communications Support Element (JCSE) announced the availability of four AN/TSC-122 HF Multichannel Communications Central. USCINCPAC requested these items for the Pacific Theater, and their request was granted. Two were transferred to USARPAC units and two to PACAF units. The AN/TSC-122s would replace older, less capable HF equipment to support USPACOM missions.¹⁴

High Frequency Radio Network Consolidations(U)

(U) Numerous recommendations to consolidate service HF radio networks in Hawaii, as well as throughout the theater, were agreed to or under discussion in order to save manpower and

UNCLASSIFIED

money, while maintaining or even improving quality of service. Most of these were part of or would become part of the DOD Worldwide High Frequency Radio Right-Sizing Plan.¹⁵

(U) The US Navy High Command (HICOM) HF Network was an unsecure HF voice system that was part of the Emergency Action Messages (EAM) delivery system. It was also used by ships to contact land-based and command and control stations. HICOM was a backup system to satellite communications for most ships. The USAF Global HF System was a common-user system that provided voice and data communications between the NCA, DOD, and aircraft of the US Government during peacetime, contingencies, and war.

(U) On 18 November 1993, the Navy proposed all US Navy HICOM traffic that could not be transferred to the International Maritime Satellite (INMARSAT) utilize the USAF Global HF System. USAF concurred on 14 December 1993. A meeting was then held to work out the issues to merge US Navy HICOM into the USAF Global HF System. Joint Staff subsequently approved a Memorandum of Policy (MOP) 79 request to consolidate the systems. Consolidations worldwide were completed in September 1994.¹⁶

(U) From a PACAF perspective, MOP 79 allowed PACAF to reduce manpower and cease HF operations at two sites and still meet all existing communications requirements. In Hawaii, this action moved the National Weather Service (NWS) Marine Weather Forecasts (2 levels) from Ewa Beach to the NCTAMS EASTPAC Lualualei HF transmitter site, the Bellows AFS transmit HF missions to the FAA site at Ewa Beach, and the Wahiawa HF receiver to the Molokai HF receiver site.¹⁷

UNCLASSIFIED

THIS PAGE INTENTIONALLY LEFT BLANK

308
UNCLASSIFIED

UNCLASSIFIED

SECTION III—COMBINED INTEROPERABILITY(U)

Operations/Intelligence Multi-Level Security Interface Installation(U)

(U) Operations/Intelligence Workstations which provided USCINCPAC with its first Multi-Level Security (MLS) capability were installed on the Joint Deployable Intelligence Support System in November 1994. An installation team composed of contractors and personnel from JICPAC and USCINCPAC installed three Compartmented Mode Workstations: two at JICPAC and one at the USCINCPAC Command Center. The workstations provided an MLS link between the Top Secret/SI and Secret/collateral JDISS LANs. The MLS capability provided users the ability to send and receive E-mail, imagery, and files between the two classified systems. The MLS system was tested and approved for use during Exercise TANDEM THRUST 95 in December 1994.¹⁸

Secure Network Server Installation at USCINCPAC(U)

(U) A Secure Network Server (SNS) was installed on the HQ USCINCPAC LAN by an installation team made up of contractors and personnel from NSA, DISA, and USCINCPAC. The SNS is the primary hardware of NSA's Multilevel Information Systems Security Initiative (MISSI) Standard Mail Guard. This capability, when applied to the HQ USCINCPAC Secret-High C2S2 LAN with an additional security "firewall," would give the command the ability to send and receive unclassified E-mail from individual workstations on the C2S2 LAN. This MLS two-way capability would be the first for any unified or major command. Installation preparations were completed in December 1994, with follow-on equipment installation and testing planned for early 1995.¹⁹

UNCLASSIFIED

Combined Interoperability Program(U)

(U) The USCINCPAC Combined Interoperability Program (CIP) provides command and control and communications (C3) interoperability through bilateral MOUs or MOAs with participating nations. Achieving and maintaining C3 interoperability benefited mutual security and served as a force multiplier during coalition operations. Implementation of USCINCPAC's Cooperative Engagement Strategy provided added emphasis for the CIP. The scope of the program and C3 issues with each country varied as defined by the MOU or MOA. The CIP required only one annual bilateral meeting, but in most cases a bilateral Command and Control Interoperability Board (CCIB) met semiannually, once in the foreign nation and once in the US, to administer the CIP. Prior to 1994, MOUs were signed between the US and four other nations: Australia, Republic of Korea, Thailand, and Singapore. An additional agreement was signed with Japan in 1994.

Australia CCIBs(U)

(U) The original CIP MOU with Australia was signed in 1987, and the US/Australia CIP was the most mature of all the combined interoperability programs. There were two US/Australia CCIBs in 1994. The first (94-1) was held at HMAS Watson's Bay, Sydney, Australia, 18-21 April. An updated MOU was presented to the US concerning the development and achievement of combined C2 systems interoperability, and Australia agreed to explore expanding the scope of the CCIB to issues involving the operational level of war. The USCINCPAC Deputy Director for Command and Control and Communications Systems (J60) presented the USPACOM C4I Convergence Briefing which focused on efforts to integrate C4I systems in the Pacific to support the warfighter at the strategic to operational levels. Presenting this briefing was a first step in fulfilling a USCINCPAC commitment to Commander Joint Forces

UNCLASSIFIED

Australia (CJFA). Australia also revealed a decision by the Chief of the Defence Forces (CDF) to stand up CJFA as a full-time command.²⁰

(U) The second US/Australia CCIB (94-2) was held in San Diego, California, 17-19 October 1994. The CCIB discussed the Tactical Automated Digital Information Link (TADIL) status updates. The CCIB also received an update on the planned, first ever combined interoperability test between US and Australian TADIL systems. Significant progress in Message Text Format (MTF) interoperability was also reported. The CCIB discussed the possibility of expanding their role to involve additional C2 systems and associated information exchange standards.²¹

Republic of Korea CCIBs(U)

(U) The ROK signed its first CIP MOU with the US in November 1989. There were two US/ROK CCIBs in 1994. The first (94-1) was in May in Seoul, Korea, and the second (94-2) was hosted by USCINCPAC J6 at Camp Smith, Hawaii, 11-14 October. The 94-2 CCIB was considered the most successful meeting as the ROK agreed to expand the scope of the CCIB to cover combined interoperability issues beyond data links and message text formats. The expanded focus included the following combined interoperability issues: ROK SPIDER to US Mobile Subscriber Equipment tactical switching network interoperability; ROK-US Combat Net Radio interoperability and the ROK Single Channel Air Ground Radio System (SINCGARS) purchase; and secure voice interoperability (US STU-III A to ROK releasable STU-IIB).²²

Singapore CCIB(U)

(U) The USCINCPAC Combined Interoperability Division hosted the seventh US/Singapore CCIB 6-9 June 1994 at Camp Smith, Hawaii. Key issues addressed included revision of the

UNCLASSIFIED

Configuration Management MOU, Singapore's agreement to accept Allied Data Processing Publication-11 (AdatP-11) as the combined US/Singapore tactical data link (TADIL) standard operating procedure, Singapore's agreement to expand the scope of the CCIB into the combined exercise area, and US/Singapore resolution of combined TADIL A interoperability problems. This was the only CCIB held with Singapore during 1994.²³

Thailand CCIBs(U)

(U) The US/Thailand CCIB 94-1 was hosted by the Royal Thai Air Force in Pattaya, Thailand, 1-3 February 1994. The CCIB discussed various configuration management issues, including updates on the Configuration Management MOU, Terms of Reference (TOR), and the Security MOU. Additionally, the CCIB discussed Exercise COBRA GOLD 93 lessons learned, plans for COBRA GOLD 94, and future TADIL A link opportunities between the USN and the Royal Thai Air Defense System (RTADS). Two combined interoperability issues were resolved:²⁴

- (U) Thailand agreed to a 1 May 1994 implementation date for use of US Message Text Format (USMTF). Use of these message formats would improve Thailand's interoperability with US forces during combined operations.

- (U) Thailand expanded participation in the CCIB to include the Royal Thai Navy (RTN). RTN participation in the meetings was beneficial to Thailand's joint interoperability needs as well as expanding USCINCPAC's combined interoperability initiatives with Thailand.

(U) Following the CCIB 94-1, the USCINCPAC Director of the Pacific Command Combined Interoperability Program (J65) met with the Thai Supreme Command's Director of Communications (LTG Vinai) on 4 February. The CIP Director discussed three main subjects with LTG Vinai.

UNCLASSIFIED

- (U) He provided a summary of the just completed US/Thailand CCIB.

- (U) He gave LTG Vinai copies of the Joint Staff publications 6-0, "Doctrine for C4 Systems Support to Joint Operations," and 6-05.1, "Employment of Joint Tactical Communications Systems-Joint Tactical Communications Systems Management," to help the Thais understand how the US conducts joint communications planning.

- (U) He explained the USCINCPAC three-phased proposal to conducting an eventual combined communications exercise. LTG Vinai agreed to the US graduated approach.

This meeting continued the dialog between the communications communities of USCINCPAC and the Supreme Command and supported the CINC's Cooperative Engagement Strategy.²⁵

(U) The eleventh meeting of the US/Thailand CCIB and the second of 1994 (94-2) met in Honolulu, Hawaii, 1-4 August. Significant progress was made toward US/Thailand C3 interoperability. Highlights of the meeting included first time representation of all Thai Services and the Royal Thai Supreme Command (RTSC); reports on upgrades, both in software and facilities, to the Royal Thai Air Defense System (RTADS); reports from Exercise COBRA GOLD 94 and information on current and future Royal Thai Navy TADIL capabilities. Concurrent with CCIB 94-2, the first US/Thailand Message Text Format (USMTF) Working Group was held.²⁶

Japan CIP Negotiations(U)

(U) Negotiations to conclude a Configuration Management MOA for the interoperability of command and control and communications systems with Japan had been on-going since 1989. At a US/Japan Technology Review Group meeting 14-15 February 1994 at Griffiss AFB, New York, several key issues were resolved which

UNCLASSIFIED

speeded up the conclusion of the agreement. The final agreement, which for political reasons was known as a "Record of Discussion" (ROD) rather than a MOA, was signed in May 1994. The ROD established the US/Japan Interoperability Management Board (IMB), which was the equivalent of a CCIB, as a forum to oversee configuration management of the interoperability standards employed by select C3 systems in use both within the US DOD and the Japan Defense Agency (JDA). The first IMB was scheduled to meet in January 1995.²⁷

CIP Introduction to Armed Forces of the Philippines(U)

(U) The Director of the USPACOM CIP met with members of the Armed Forces of the Philippines' (AFP's) General Command and Services at the AFP General Headquarters on 7 February 1994. The purpose of the visit was to introduce the CIP to the AFP and invite them to join in the program as part of USCINCPAC's efforts to expand the CIP to other important Pacific nations. Following several office calls, the CIP Director briefed the CIP to an audience of over 40 General Command and Service representatives. The briefing was well received and seemed to generate considerable interest. The objective was to eventually conclude a configuration management MOA with the Philippines to allow for interoperability on specified systems.²⁸

Malaysia CIP Brief(U)

(U) USCINCPAC representatives presented the USCINCPAC CIP Brief to the Malaysian Ministry of Defence in December 1994. The purpose was to reintroduce the CIP and, until the Malaysian Government decided to formally join the program, offer the opportunity to pursue C3 interoperability discussions through the Bilateral Training and Consultative Group (BITACG). The response was favorable, although the audience was not at the decision-

UNCLASSIFIED

making level. Discussions indicated that there was a sincere interest in interoperability and COMSEC.²⁹

USCINCPAC Instruction for OTAR and OTAT(U)

(U) The Deputy USCINCPAC signed USCINCPAC Instruction 10390.1, "USPACOM Over-the-Air Rekeying and Over-the-Air Transfer Procedures for Cryptographic Key," making this command the first unified command to institutionalize OTAR and OTAT procedures for Joint exercises and operations. This marked the first step in transitioning USPACOM COMSEC procedures into electronic key management and distribution.³⁰

USPACOM INFOSEC Conference(U)

(U) The USCINCPAC Information Systems Security Branch (J652) sponsored the annual USPACOM Information Systems Security (INFOSEC) Conference 25-29 April 1994 at Fort DeRussy, Hawaii. More than 140 INFOSEC personnel attended representing DOD, Joint Staff, NSA, DISA, and all USPACOM service components and subunified commands. Attendees received more than 50 Communications Security/Computer Security (COMSEC/COMPUSEC) and security related briefings, including working demonstrations of the Joint Key Management System (JKMS) hardware (LMD/KP). Additionally, J652 chaired four issue forums/working groups: Allied COMSEC Interoperability, US COMSEC Interoperability, COMPUSEC, and the Multilevel Security Working Group. These forums identified and tasked for action more than 25 pressing INFOSEC issues in the Pacific Theater.³¹

Spectrum Management Conference(U)

(U) The 1994 Spectrum Management Conference was held at the Ilikai Hotel in Honolulu, Hawaii, 17-23 July. This was an annual conference hosted by the Joint Frequency Management Office-

UNCLASSIFIED

Pacific (JFMO-PAC) which provided an international forum for cooperative engagement and enhanced positive relationships with host nations from whom USCINCPAC required frequency management authorizations. The conference agenda was based upon spectrum management concepts, procedures, and analyses pertaining to the ever-changing demands being placed upon the electromagnetic spectrum due to emerging technologies. USCINCPAC J6, BG Gerard P. Brohm, USA, gave welcoming remarks and opened the conference. Numerous Pacific and Indian Ocean nations were represented. Also in attendance were the Director and Deputy Director of Space and Nuclear C3, Office of the Assistant Secretary of Defense and the Director of the Joint Spectrum Center. A total of 150 representative attended the conference and workshops.³²

Pacific Senior Communicators Meeting(U)

(U) The fourth annual Pacific Senior Communicators Meeting (PSCM) was held 9-10 November 1994 at Hickam AFB, Hawaii. The countries represented were Thailand, Philippines, Malaysia, Fiji, Indonesia, Sri Lanka, Bangladesh, and Australia. Each country, including the US, presented a briefing on their respective national communications organization, structure, and relationships. The US provided briefings on the CIP, Crisis and Disaster Planning, Multinational Communications exercises, Video Teleconferencing, and Spectrum Management. Open discussion followed each presentation. All participants agreed that the PSCM provided a valuable forum and that it was progressing toward a more active body. There was also considerable discussion on the "new found roles" for the US and other nations since the collapse of the USSR. A charter or terms of reference was to be created and future PSCMs would be developed around themes. It was suggested that the PSCM might be rotated among participating nations. The topic that was of greatest interest for all was threat of natural disasters and the role of communications planning and civil preparedness.³³

UNCLASSIFIED

SECTION IV—ADP, WWMCCS, AND BASE COMMUNICATIONS(U)

Automated Message Handling System(U)

(U) As part of the USCINCPAC plan to go paperless, several automated message handling systems (AMHSS) were examined. The Electronic Collateral Support System (ELCSS), which was being used successfully at JICPAC, was selected for use. TRW was the contractor for the ELCSS system. The ELCSS allowed users to access messages from their PCs via the C2S2 LAN by establishing profiles or through journal searches. Final cutover to a Personal Computer Message Terminal would allow the Navy to remove its Local Digital Message Exchange (LDMX).

(U) ELCSS software was installed on the Sun SPARC Workstation on 11 April 1994. Directorate executive assistants and users involved in message dissemination received initial ELCSS training on 19 April. These users began receiving unclassified message traffic via ELCSS so they could assist in building and editing the profiles for their directorates. Message traffic, classified up through Secret, became available for all personnel connected to the C2S2 LAN beginning 24 May. Paper distribution of messages continued until the ELCSS profiles were firmly established and J66 personnel were satisfied that the AMHS was adequately handling message distribution. The target cut off of paper message distribution was not later than 30 June 1994. The success of the ELCSS on the C2S2 LAN allowed plans for the removal of the LDMX to go forward. Cutover to a Personal Computer Message Terminal occurred in October 1994. The Naval Telecommunications Center (NTCC) continued paper distribution for special category, focal point, and TS traffic.³⁴

UNCLASSIFIED

USPACOM C2 ADP Plans and Requirements Conference(U)

(U) The USPACOM C2 ADP Plans and Requirements Conference was held the week of 11-15 April 1994, with the 1854th Combat Information Systems Squadron (1854 CISS) serving as co-host. The conference used to be referred to as the USPACOM WWMCCS ADP Plans and Requirements Conference. The change from "WWMCCS" to "C2" reflected the planned change from WWMCCS to GCCS, and also the need to consider all C2 ADP systems. The conference also marked the beginning of an effort to gain wider involvement, although it was agreed that it should continue to be a J66 technical conference. Topics discussed included WWMCCS, WWMCCS Consolidation wrap-up, GCCS, Theater Command and Control System, Operations Support System (OSS), and communications.³⁵

Unofficial Telephone Service(U)

(U) Unofficial telephone service refers to all private telephones, i.e., all telephones not used in an official capacity, primarily telephones found in living quarters. In Hawaii, the military was always responsible for the installation and maintenance of the support systems for commercial telephone lines to on-post quarters. GTE-Hawaiian Telephone (GTE-HAWTEL) was responsible for the installation and maintenance of the telephone lines to the quarters. When USCINCPAC consolidated all Hawaii on-post housing under the Army around 1982, the Oahu Consolidated Family Housing Office (OCFHO) assumed the support responsibility. Unfortunately, OCFHO neglected this responsibility and some serious problems developed in the support systems. GTE-HAWTEL identified 78 support structure problems. In May 1994, estimates to repair 53 of these problems was \$2,200,000. OCFHO used GTE-HAWTEL's prioritized list of projects and allocated \$200,000 in FY 94 to repair just the top ten.

UNCLASSIFIED

(U) GTE-HAWTEL was reluctant to maintain the telephone lines due to the poor condition of the support structures. They placed a tariff before the Hawaii Public Utilities Commission (PUC) to allow them to provide telephone service only to the boundaries of each military installation; the military would assume responsibility from that point to the quarters. (There was precedent for this tariff in California, where the California PUC ruled that a military installation could be considered a "campus environment." The military was contesting this tariff and the "campus environment" status.)

(U) Two issues needed to be resolved. The first was the GTE-HAWTEL proposed tariff. The Defense Information Systems Agency Pacific (DISA PAC) was working this issue and requested a declaratory ruling from the Hawaii PUC that names GTE-HAWTEL as the military family housing (MFH) telephone service provider.

(U) The second issue was the immediate concern for the condition of the telephone system support structures. The total estimated cost of repair for all support structures was approximately \$20,000,000. Work began with the USCINCPAC J4 action officers placing the funding for the support structures under the MFH umbrella. Also, USCINCPAC coordinated with DISA PAC to negotiate shared funding of the repairs with GTE-HAWTEL.

(U) By July a consensus was reached at USCINCPAC. The consensus was:

- (U) The military should get the support structures up to the current community standard and then turn the maintenance responsibility over to GTE-HAWTEL.

- (U) Get the service installation representatives together to determine points of contact (POCs), agree who will lead the negotiations with GTE, and get GTE on line with the

UNCLASSIFIED

money they need. USCINCPAC needed solid cost estimates broken down by service as soon as possible.

- (U) Work an agreement with GTE to treat MFH the same as local housing developments.

- (U) Get USARPAC lawyers and DISA on line for technical assistance and the lead with the regulatory law issues.

(U) Action officers were looking at information concerning GTE's efforts with MPOE at Twenty-nine Palms, California. This was to provide a precedent which could be used in the Hawaii situation, some answers about DOD policy, and some idea about the actual amount of support which could be expected.³⁶

UNCLASSIFIED

FOOTNOTES FOR CHAPTER VI

- 1 Telecon (U), Robert S. Stubbs, Historian with LCDR Dorothy M. Janson, J60A (Acting), 13 Nov 95; HistSum (U), J662, "Reorganization," 12 Apr 94 (SD 6-1).
- 2 HistSum (U), J6224, "Contingency Theater Automated Planning System (CTAPS) Testing," 13 Jul 94 (SD 6-2); Msg (U), USCINCPAC/ J37 to CINCPACFLT/N63, "CTAPS Working Group Meeting," 290009Z Mar 94 (SD 6-3); Msg (U), PACAF/DO to SAF/IA, "Joint Contingency TACS Automated Planning System (CTAPS) Data Base Releasability to the Republic of Korea (ROK) for 7AF War Fighting Requirements," 291908Z Mar 94 (SD 6-4); Msg (S-DECL OADR), COMUSKOREA/FKJ6-D to USCINCPAC/J3/J6/J62, "Korean AOR CTAPS Afloat (U)," 191300Z Dec 94 (SD 6-5) (information used is Unclassified); Msg (U), PACAF/DO to USCINCPAC/J3/J6, "CTAPS Software Transition to Version 5.1," 240748Z Jan 95 (SD 6-6).
- 3 HistSum (U), J6224, "Tandem Thrust 95," 4 Jan 95 (SD 6-72).
- 4 HistSum (U), J6222, "COBRA GOLD 94 Middle Planning Conference," 16 Feb 94 (SD 6-7); HistSum (U), J6222, "Exercise COBRA GOLD 94," 15 May 94 (SD 6-8).
- 5 HistSum (U), J6223, "DJTFAC Deployment - TEMPO BRAVE 94-1," 12 May 94 (SD 6-9).
- 6 HistSum (U), J62(A), "[JCMC-1 equipment], 30 Sep 94 (SD 6-10).
- 7 HistSum (U), J6414, "Pacific Video Teleconferencing (PACVTC) Network," 14 Jun 94 (SD 6-11); HistSum (U), J6414, "Pacific VTC Net," [ca. Oct 94] (SD 6-35); Rpt (U), J6414, "FY 94 CINC Initiative Fund Fourth Quarter, Status Report," [ca. Oct 94] (SD 6-36).
- 8 HistSum (U), J6421, "Joint Worldwide Intelligence Communications System (JWICS) for Korea," 17 Feb 94 (SD 6-12); Msg (U), NISEWEST/220 to USCINCPAC/J21/J6/J3-CCIP, "JWICS Status," 082307Z Aug 94 (SD 6-13); Msg (U), DISA PAC/DPO to DECCO/RPCI/RRB, "Operational Directive Message for 267V," 121119Z Aug 94 (SD 6-14); HistSum (U), J6415, "Joint Worldwide Intelligence Communications System (JWICS) to Korea," [ca. Sep 95] (SD 6-15).
- 9 HistSum (U), J6414, "Survivable Communications Integration System (SCIS) Fallback/Processing and Display Subsystem (PDS) Installation," 16 Mar 94 (SD 6-16).
- 10 Msg (C-DECL OADR), USCINCPAC CAT to 7th AF/DO, "ITO Dissemination Over AUTODIN(U)," 262312Z Aug 94 (SD 6-17); Msg (U), KCSS 7AF/DO to CINC UNC CFC/CFCB-PL-PT, "ITO Dissemination Over AUTODIN," 270905Z Aug 94 (SD 6-18); Msg (C-DECL OADR), Joint Staff/J6 to DA/DAMO-FDC/SAIS-ZA, "Air Tasking Order (ATO) Transmission Over AUTODIN (U)," 302201Z Sep 94 (SD 6-19); Msg (S-DECL OADR), KCSS 7AF/DOPQ to COMSOCKOR/SOJ2/SOJ3, "ITO Dissemination (U)," 060049Z Oct 94 (SD 6-20).
- 11 Msg (U), Joint Staff/J61 to DA/DAMO-FDC/SAIS-ZA, "Air Tasking Order (ATO) Interoperability Working Group (AIWG) Meeting Minutes," 160925Z Sep 94 (SD 6-21); Msg (U), USCINCPAC/J30/J6 to Joint Staff/J61, "Contingency Theater

UNCLASSIFIED

Automated Planning System (CTAPS) Version 5.1 Fielding Plan," 270135Z Sep 94 (SD 6-22); HistSum (U), J6414, "CTAPS," [ca. Dec 94] (SD 6-23).

12 Memo (U), DISA/CFE to DISA/TE, "Update Report on JRD Submarine Fiber Optic Cable (SFOC) Repair Effort, 8 Feb 94," 8 Feb 94 (SD 6-24); HistSum (U), J6411, "Japan Reconfiguration and Digitization (JRD) Phase III," 18 Feb 94 (SD 6-25); HistSum (U), J6411, "Japan Reconfiguration and Digitization (JRD) Phase III Repair of submarine Fiber Optics Cable (SFOC)," 16 Mar 94 (SD 6-26); HistSum (U), J6411, "Japan Reconfiguration and Digitization Phase III," [ca. Jun 94] (SD 6-27).

13 HistSum (U), J642, "USCINCPAC Red Telephone Switch," 27 Jan 94 (SD 6-28); HistSum (U), J6411, "USCINCPAC Defense Red Switch Network (DRSN) Redirection Effort," 18 Feb 94 (SD 6-29); Msg (U), COMUSKOREA/FKJ6 to DISA/DIR, "Defense Red Switch Network (DRSN)," 230148Z May 94 (SD 6-30); HistSum (U), J662, "GTE Red Telephone Switching Subsystem (RTSS)," 13 Jul 94 (SD 6-83); E-Mail Msg (U), USCINCPAC J6411 to USCINCPAC J60, "Re: Cut-over Delay," 22 Aug 94 (SD 6-31); E-Mail Msg (U), USCINCPAC J6411 to USCINCPAC J6, "ESI-Government Meeting Notes for 30 August," 1 Sep 94 (SD 6-32); HistSum (U), J6411, "Defense Red Switch Network (DRSN)," [ca. Oct 94] (SD 6-33); Inter-Office Memo (U), J6411 to All Concerned, "ESI Red Switch Installation," 6 Oct 94 (SD 6-34); HistSum (U), J6623, "Defense Red Switch Network (DRSN) Installation," [ca. Jan 95] (SD 6-84).

14 Msg (U), USCINCPAC J64 to Joint Staff/J6J, "USPACOM Request for JCSE Excess Equipment," 011810Z Jun 94 (SD 6-37); Msg (U), Joint Staff/J6J to USCINCPAC/J6/J64, "JCSE Excess Equipment Disposition," 232040Z Jun 94 (SD 6-38); HistSum (U), J6411, "Transfer of AN/TSC 122s to PACOM," [ca. Oct 94] (SD 6-39).

15 MOU (U), Memorandum of Agreement Between the United States Navy and the United States Air Force for High Frequency Radio Communications, 9 Dec 93 (SD 6-40); United States Department of Defense Worldwide High Frequency Radio Right Sizing Plan (U), prepared by USAF for Joint Staff, Jun 95.

16 Msg (U), CINCPACFLT/N6 to USCINCPAC/J6, "MOP 79 Request for Navy HICOM-USAF Global HF Net Consolidation," 300158Z Jun 94 (SD 6-41); Msg (U), USCINCPAC/J6 to Joint Staff/J6, "CINCPACFLT MOP 79 Request for Navy HICOM-USAF Global HF Net Consolidation," 191801Z Jul 94 (SD 6-42); Msg (U), CNO/N61 to CINCPACFLT/N6, "Navy HICOM-USAF Global HF Net Consolidation," 061936Z Sep 94 (SD 6-43); HistSum (U), J6411, "MOP 79 Request for Consolidation of Navy HICOM and USAF Global Net," [ca. Oct 94] (SD 6-44).

17 Msg (U), USCINCPAC/J01 to Joint Staff/J6, "MOP 79 Request for Air Force High Frequency (HF) Communications in Hawaii," 062100Z Jun 94 (SD 6-45); HistSum (U), J6411, "MOP 79 Request for AF HF Communications in Hawaii," [ca. Jul 94] (SD 6-46); Msg (U), Joint Staff/J62 to USCINCPAC/J01, "MOP 79 Request for Air Force High Frequency (HF) Communications in Hawaii," 061415Z Jul 94 (SD 6-47).

18 HistSum (U), J652, "Operations/Intelligence Interface (MLS) Installation," 10 Jan 95 (SD 6-48).

UNCLASSIFIED

- 19 HistSum (U), J652, "Secure Network Server Installation at USCINCPAC," 10 Jan 95 (SD 6-49).
- 20 HistSum (U), J6512, "Australia - United States Command & Control Interoperability Board (CCIB) 94-1, 18-21 Apr 94," 13 May 94 (SD 6-50); Information Paper (U), J651, "Australian Participation in the USPACOM Combined Interoperability Program (CIP)," 1 Sep 94 (SD 6-51).
- 21 HistSum (U), J651, "US/Australia Combined Interoperability Test Planning Meeting," 11 Apr 94 (SD 6-52); HistSum (U), J6512, "US/Australia Command and Control Interoperability Board (CCIB)," 10 Jan 95 (SD 6-53).
- 22 HistSum (S-DECL OADR), J652B, ". . . Relations with Republic of Korea," 26 Jul 94 (SD 6-54) (information used is Unclassified); Information Paper (U), J6512, "USCINCPAC Combined Interoperability Program (CIP) with the Republic of Korea," 27 Jul 94 (SD 6-55); Talking Paper (U), J6512, "Korean Participation in the USPACOM Combined Interoperability Program," 27 Jul 94 (SD 6-56); Information Paper (S-DECL OADR), J6512, "C3 Interoperability with the Republic of Korea (ROK) (U)," 27 Jul 94 (SD 6-57) (information used is Unclassified); FOXTROT Msg (U), USCINCPAC J6 to J00, "US/ROK Command & Control Interoperability Board (CCIB) 94-2 Summary Report," [ca. Oct 94] (SD 6-58).
- 23 HistSum (U), J651, "U.S./Singapore Command and Control Interoperability Board (CCIB) 94-1," 12 Jul 94 (SD 6-59); Telecon (U), Robert S. Stubbs, Historian, with Maj Robert Yingling, USA, J6511, 27 Nov 95.
- 24 HistSum (U), J6511, "U.S./Thailand Command and Control Interoperability Board (CCIB) 94-1," 14 Mar 94 (SD 6-60).
- 25 HistSum (U), J65, "Visit to Royal Thailand Supreme Command Headquarters," 14 Mar 94 (SD 6-61).
- 26 SSS (U), J651, "Summary Report of US/Thailand Command and Control Interoperability Board 94-2," 12 Aug 94 (SD 6-62).
- 27 HistSum (U), J65, "USPACOM CIP Negotiations with the Japan[sic]," 14 Mar 94 (SD 6-63); HistSum (U), J651, "US/Japan Interoperability Management Board," 12 Jul 94 (SD 6-64); Information Paper (U), J651, "Combined Interoperability with the Japan Self Defense Force," 12 Jul 94 (SD 6-65).
- 28 HistSum (U), J65, "Introduction of USPACOM Combined Interoperability Program (CIP) to the Armed Forces of the Philippines (AFP)," 14 Mar 94 (SD 6-66).
- 29 HistSum (U), J6511, "USCINCPAC Combined Interoperability Program (CIP) Brief to Malaysia," 10 Jan 95 (SD 6-67).
- 30 HistSum (U), J652, "USCINCPAC Instruction 10390.1," 16 Feb 94 (SD 6-68).
- 31 HistSum (U), J652, "1994 USPACOM INFOSEC Conference," 13 May 94 (SD 6-69).

UNCLASSIFIED

32 HistSum (U), J653, "1994 Spectrum Management Conference," 19 Sep 94 (SD 6-70).

33 HistSum (U), J651C, "Pacific Senior Communicators Meeting," 10 Jan 95 (SD 6-71).

34 HistSum (U), J6612, "Automated Message Handling System (AMHS)," 24 Jan 94 (SD 6-73); HistSum (U), J6612, "Automated Message Handling System (AMHS)," 24 Jan 94 (SD 6-74); HistSum (U), J6612, Automated Message Handling System (AMHS)," 14 Feb 94 (SD 6-75); HistSum (U), J6612, "Automated Message Handling System (AMHS)," 14 Mar 94 (SD 6-76); HistSum (U), J6612, "Automated Message Handling System (AMHS)," 12 Apr 94 (SD 6-77); HistSum (U), J6612, "Automated Message Handling System (AMHS)," 11 May 94 (SD 6-78); HistSum (U), J6612, "Automated Message Handling System (AMHS)," 13 Jun 94 (SD 6-79); HistSum (U), J6612, "Automated Message Handling System (AMHS)," 13 Jul 94 (SD 6-80); HistSum (U), J6611, "AMHS/LDMX Removal," undated (SD 6-81).

35 HistSum (U), J6612, "USPACOM C2 ADP Plans and Requirements Conference," 11 May 94 (SD 6-82).

36 HistSum (U), J6612, "Unofficial Phone Service," 11 May 94 (SD 6-85); HistSum (U), J6612, "Unofficial Phone Service," 13 Jun 94 (SD 6-86); HistSum (U), J6612, "Unofficial Phone Service," 13 Jul 94 (SD 6-87); HistSum (U), J6611, "Regulated Phone Service," undated (SD 6-88).

UNCLASSIFIED

CHAPTER VII(U)

OTHER SUPPORTING ACTIVITIES(U)

SECTION I—OFFICIAL ACTIVITIES OF THE COMMANDER IN CHIEF(U)

Trips and Associated Activities(U)

(U) The trips and associated activities of USCINCPAC in 1994 are summarized chronologically below. All times are local. The CINC was usually accompanied by appropriate staff members on trips throughout the USPACOM area. Limitations of time and space restrict coverage to only the official aspects of each trip: Identification of staff members who accompanied him and a complete description of official representational and social functions connected with his travels are omitted. Unless otherwise indicated, USCINCPAC traveled aboard a USAF VC-135 aircraft operated by 65th Airlift Squadron, stationed at Hickam AFB, Hawaii. In addition, this section includes a list of distinguished visitors to Hawaii greeted by USCINCPAC or who called at his Camp H. M. Smith Headquarters, and also describes the CINC's activities in Hawaii such as speeches presented, meetings with local officials and media representatives, and participation in local ceremonies and media events. In general, the calls with foreign officials referred to throughout this chapter included an overview of current U.S. defense policies, discussion of current issues of mutual interest, and the discussion of specific U.S. concerns and desires. Calls with U.S. officials included reports on the status of USPACOM forces and an update on country-specific political-military issues within the USPACOM AOR.¹

(U) Vietnam and the Philippines, 14-20 January 1994: ADM Larson's his first visit as CINCPAC to the Socialist Republic of

UNCLASSIFIED

~~CONFIDENTIAL~~

Vietnam (SRV) originated at Hickam Air Force Base (HAFB) on Friday, 14 January. He stopped at Andersen AFB, Guam en route and landed in Hanoi on 16 January. He was met by Mr. Nguyen Xuan Phong, Director of the Americas Department, SRV, and MG Thomas H. Needham, USA, LTC John C. Cray, USA, and MAJ Roger L. Overturf, USA, from Joint Task Force Full Accounting (JTF-FA). While in Hanoi, ADM Larson visited members of the JTF-FA Hanoi Detachment and met with SRV government representatives about prisoner of war/missing in action (POW/MIA) issues.²

(U) During his day-and-a-half stay in Hanoi, he met with President Le Duc Anh, Minister of Foreign Affairs Nguyen Manh Cam, Deputy Minister of Foreign Affairs Le Mai, and Deputy Minister for International Affairs LTG Nguyen Thoi Bung. He also visited the JTF-FA Detachment (Det) 2 compound in Hanoi, nicknamed "The Ranch," the Joint Document Center at the Central Army Museum (CAM), and gave a press conference. He departed Hanoi for Da Nang at 1515 on 17 January.

(U) On Tuesday, 18 January, after receiving briefings from the JTF-FA Priority Case Investigation Team (PCIT) and Investigation Element (IE) 2, he flew via MI-8 to Kontum and Gai Lai to visit personnel participating in the 27th Joint US-Vietnam Joint Field Activity (JFA) and received briefings about IE progress at each site. He departed Da Nang at 1545 en route to Camp Aguinaldo, Manila.

(B)(1)(1.4d)



~~CONFIDENTIAL~~

~~CONFIDENTIAL~~

(B)(1)(1.4d)

(U) Washington, DC, 23-28 January: The CINC departed HAFB at 2100 on Sunday, 23 January for Washington, DC to make official calls on the Honorable Les Aspin, Secretary of Defense (SECDEF), the Honorable Anthony Lake, Assistant to the President for National Security Affairs, and GEN John Shalikashvili, USA, Chairman, Joint Chiefs of Staff (CJCS). He returned on 28 January.

(U) Washington, DC and Naval Air Station North Island, CA, 5-11 February: ADM Larson undertook this trip to attend meetings, including the Chief of Naval Operations (CNO) Executive Steering Committee (ESC) meeting, and to make official calls. He departed HAFB at 2100 on Saturday, 5 February and arrived at Andrews AFB at 1040 on Sunday. On 7 February he called on Mr. Frank G. Wisner, Under SECDEF for Policy, the Honorable Robert L. Galluci, Assistant Secretary for Political Military Affairs, Ambassador Winston Lord, Assistant Secretary for East Asian and Pacific Affairs, and ADM David E. Jeremiah, USN, Vice Chairman, Joint Chiefs of Staff (VCJCS) and was called on by Rear Admiral (RADM) Frederick L. Lewis, USN, Commander, Naval Doctrine Command. Tuesday, he called on the Honorable William J. Perry, SECDEF (confirmed by the Senate on 3 February), Senator John F. Kerry (D-MA), Senator John McCain (R-AZ), Representative Gary L.

~~CONFIDENTIAL~~

UNCLASSIFIED

Ackerman (D-NY), the Honorable John H. Dalton, Secretary of the Navy (SECNAV), the Honorable Richard J. Danzig, Under SECNAV and the Honorable Leon Furth, National Security Advisor to the Vice President, and was called on by MG Needham.

(U) The CNO ESC meeting was conducted Wednesday and Thursday, 9-10 February, at the Center for Naval Analyses (CNA). On Wednesday, ADM Larson gave the meeting's welcoming remarks. Late Wednesday afternoon ADM Larson left the meeting for a half-hour meeting with GEN Shalikhshvili and returned to provide the day's closing remarks. ADM Larson departed CNA for Andrews AFB at 1600 on Thursday, rested overnight at Naval Air Station (NAS) North Island, and arrived at HAFB at 1340, 11 February.

(U) Washington, DC, New York City, NY, and NAS North Island, CA, 22 February-2 March: The CINC departed HAFB at 2100 on 22 February and arrived at Andrews AFB at 1100 the following morning. At 1600 he called on the Honorable Anthony Lake in the West Wing of the White House. On 24 February he met with Senator Sam Nunn (D-GA), the Honorable John H. Dalton (SECNAV), and the Honorable Richard J. Danzig, Under SECNAV. That evening, he attended ADM Jeremiah's retirement dinner at Fort Myer.

(U) On Friday, 25 February, ADM Larson participated in the CINC's Conference at the Pentagon. Topics presented and discussed included Bottom Up Review (BUR), Intelligence Budget Support, Readiness, Peacekeeping, and JTF-95. ADM Larson left the meeting for approximately two hours for a short meeting with President William J. Clinton at the White House. Upon his return, he resumed participation in the conference. At 1430 the participants departed for Fort Myer via JCS protocol vans for ADM Jeremiah's retirement ceremony.

(U) On Monday, 28 February, ADM Larson departed Andrews AFB for JFK Airport, New York City, for a mid-afternoon meeting with

UNCLASSIFIED

UNCLASSIFIED

the Time Magazine editorial board. He returned to Washington that evening. He spent 1 March making official calls at the Pentagon and preparing for his 2 March testimony before the Senate Armed Services Committee. ADM Larson departed Andrews AFB on 2 March at 1300 en route to HAFB via NAS North Island; he arrived at HAFB at 2140 that evening.

(U) Western Samoa, Australia, and Japan, 5-11 March: After departing HAFB on Saturday, 5 March at 1230 en route to Australia, ADM Larson's plane made a two-hour refueling stop in Western Samoa. He was greeted at Pago Pago by high ranking Samoan officials, including the Governor, the Honorable A. P. Lutali, and Lieutenant Governor, the Honorable Tauese Sunia. The Office of Samoan Affairs then honored ADM Larson with an award ceremony, Sua presentation, and other gifts. ADM Larson left Pago Pago at 1900 for Canberra, Australia.

(U) He arrived at Royal Australian Air Force (RAAF) Base Fairbairn at 2200 on Sunday and was met by MG John M. Connolly, OAM (Medal of the Order of Australia), Australian Army, Assistant Chief of the Defence Force (Operations). At 0720 on 7 March he traveled to the Royal Military College Duntroon, the Australian equivalent of West Point, for a breakfast meeting with LTG John M. Sanderson, AO (Order of Australia), Commander Joint Forces Australia (Designate) and COL Simon Willis, school commandant. This was followed by a trip to the American Embassy where he met with Ambassador Edward J. Perkins and received a country team brief. At 1000 he met with ADM Alan L. Beaumont, AC (Companion of the Order of Australia), Royal Australian Navy (RAN), Chief of Defence Force (CDF) and Mr. Anthony J. Ayers, AC, Secretary, Department of Defence at the Russell Offices complex. Later that afternoon he participated in a two-hour Military Representatives (MILREPS) meeting at the Russell Offices, then moved on to the Parliament House where he called on Senator the Honorable Robert

UNCLASSIFIED

UNCLASSIFIED

Ray, Minister for Defence, in the Senator's office. In the evening he was dinner guest of the CDF at the Commonwealth Club.

(U) On Tuesday, 8 March, the Australian-United States Ministerial (AUSMIN) talks began at the Cabinet suite, Parliament House. Representing the United States were the Honorable Warren M. Christopher, Secretary of State (SECSTATE), the Honorable Frank G. Wisner, Under SECDEF for Policy, and ADM Larson. That evening, the Minister for Foreign Affairs, the Honorable Gareth Evans, QC, and Senator the Honorable Robert Ray hosted a dinner for all three US officials at the Parliament House. The talks resumed at 0900 on 9 March and concluded at 1015. This was followed by a joint press conference which lasted from 1030 until 1100. The US and Australian officials proceeded to the Australian War Memorial's (AWM) Hall of Memory for the last official engagement of the day. At 1140, the SECSTATE placed a wreath on the Tomb of the Unknown Soldier; ADM Larson observed. The SECSTATE departed Canberra at noon but ADM Larson departed at 2030 for Yokota Air Base (AB) via Guam.

(U) At 0345 he stopped at Andersen AFB to refuel and was met by RADM Edward K. Kristensen, USN, USCINCPAC Representative Guam, and Maj Gen Hale Burr, USAF, Commander, Thirteenth Air Force. After an hour-and-a-half, ADM Larson departed for Yokota AB, Japan. About three hours after his 0755 arrival, he conducted a half-hour meeting at the American Embassy with the Honorable Mr. Wisner, the Honorable Stanley O. Roth, Deputy Assistant SECDEF (DASD) for East Asia and Pacific Affairs (EAP), Lt Gen Richard B. Myers, USAF, Commander US Forces Japan (COMUSJAPAN), and Ambassador Charles B. Salmon, Jr.

(U) At 1430, he conducted a courtesy call on Defense Minister General Kazuo Aichi at the Japan Defense Agency, then proceeded to a 40-minute meeting with Administrative Vice Minister Shigeru Hatakeyama of the Japan Defense Agency. This

UNCLASSIFIED

UNCLASSIFIED

meeting was followed immediately by a 65 minute meeting with General Tetsuya Nishimoto, Chairman Joint Staff Council, and his Joint Staff council and directors. The last official engagements of the day were strategy meetings with Secretary Christopher and Under SECDEF Wisner at 1615 and 1630, respectively.

(U) On Friday, 11 March, he participated in the SECSTATE's motorcade to the official residence of Prime Minister Morihiro Hosokawa for the Security Consultative Committee (SCC) (2+2) meeting. The meeting lasted from 0805 until 1020 but broke between 0905-0920 while the Ministers attended the Cabinet Meeting. At the conclusion of the SCC (2+2), ADM Larson traveled to Hardy Barracks from where he traveled by helicopter to Yokota AB. At the air base, he boarded his plane at 1115 en route to Honolulu, crossed the international dateline, and landed at HAFB on Thursday, 10 March at 2325.

(U) Washington, DC and NAS North Island, CA, 19-23 March: ADM Larson arrived at Andrews AFB at 1100 on Sunday, 20 March after departing HAFB at 2100 the night before. He began his week on Monday with meetings with GEN Shalikhvili, RADM Conrad C. Lautenbacher, Jr., USN and RADM William A. Earner, Jr., USN. At 1600 he met with Secretary Christopher at the State Department and at 1715 with Under SECDEF Wisner. At 0930 on Tuesday, he testified before the House Appropriations Committee (HAC) regarding Military Construction (MILCON) and at 1330, testified before the HAC again on Defense legislation. On 23 March, he had breakfast with Vice Admiral (VADM) Ronald J. Zlatoper, USN, and at 1030, called on GEN Gordon R. Sullivan, USA, Chief of Staff of the Army (CSA). He departed Andrews AFB at 1230 for a meeting with SECNAV Dalton at NAS North Island. Following the 1615 meeting, ADM Larson began the final leg of his trip back to HAFB and arrived at 2130.

UNCLASSIFIED

~~CONFIDENTIAL~~

(U) NAS North Island and NAS Alameda, CA, 4-6 April: The purpose of this short trip was to make official calls and to attend the Joint Task Force-5 (JTF-5) change of command ceremony. ADM Larson departed HAFB at 0800 on Monday, 4 April en route to NAS North Island. Upon arrival at 1610, he was met by VADM David B. Robinson, USN, Commander, Naval Surface Force, Pacific Fleet. The next morning, he traveled to NAS Miramar to address squadron members at the Top Gun Auditorium and in the afternoon, took a familiarization flight aboard a CH-46 from the Helicopter Combat Support Squadron (HC)-11, then addressed the sailors of HC-11.

(U) On Wednesday morning, he flew to NAS Alameda for the JTF-5 change of command and was met by VADM Martin H. Daniell, US Coast Guard (USCG), incoming JTF-5 Commander, and RADM John L. Linnon, USCG, outgoing JTF-5 Commander, and RADM Ernest F. Tedeschi, Jr., USN, Commander, Naval Base San Francisco/Commander, Logistics Group One. One hour prior to the 1300 change of command ceremony, he had a short meeting with VADM Daniell. ADM Larson departed NAS Alameda at 1500 and arrived at HAFB five-and-a-half hours later.

(B)(1) (1.4d)



~~CONFIDENTIAL~~

~~CONFIDENTIAL~~

(B)(1)(1.4d)

(U) He lost a day crossing the international dateline and arrived in New Zealand at 0800 on Sunday, 10 April. VADM Somerford F. Teagle, Chief of Defense Force, Ms. Sylvia G. Stanfield, Chargé d'Affaires, US Embassy, and Group Captain Brian Carruthers, Base Commander, were on hand to meet him. He reboarded his plane at 0900 en route to Wellington. At 1100, he landed at Queenstown for a brief tour of the city and a lunch hosted by the Assistant Chief of Defence Resources. ADM Larson resumed his flight to Wellington at 1500 and arrived at 1720.

(U) At 0825 on Monday, 11 April, he arrived at Parliament for a call on the Right Honorable Donald C. McKinnon, Deputy Prime Minister and Minister of Foreign Affairs and Trade. After the visit, he flew back to RNZAFB Ohakea for briefs about the RNZAF's A-4K aircraft, MB-339CB Aermacchi jet trainers, and a review of a static display of the A-4K and Aermacchi Plus. At noon, he flew to Linton Military Camp where he was honored with the Maori Challenge and given a briefing on the 2nd Land Force Group (LFG), a battalion-sized unit and the Army's principal operational force. He returned via helicopter to RNZAFB Ohakea, transferred to an ANDOVER for the flight to Wellington Airport. That evening VADM Teagle hosted a dinner for ADM Larson at the RNZAFB Shelly Bay's Officers' Club. On 11 April, ADM Larson met briefly with the staff of the American Embassy then proceeded to Parliament for calls on the Right Honorable James B. Bolger, Prime Minister, the Right Honorable William F. Birch, Minister of Finance, the Honorable Warren Cooper, Minister of Defense, the Opposition Labour Leader Helen E. Clark, and a meeting with Parliament's Foreign Affairs and Defence Select Committee. In the afternoon, he met with the Secretary of Defence, Mr. Gerald Hensley, VADM Teagle, and Chiefs of Staff. Lastly, he delivered

~~CONFIDENTIAL~~

UNCLASSIFIED

a speech in the Grand Ballroom of Parliament and entertained questions from the audience as well.

(U) Wednesday, 13 April, ADM Larson flew to RNZAFB Auckland and arrived at 1015. He was met by the base commander, Group Captain Bruce Ferguson, who escorted him on a tour of the base's transport and surveillance squadrons. At 1115 ADM Larson flew via helicopter to the naval base for a command brief and tour followed by lunch with Commodore Fred Wilson, RNZN, in HMNZS Philomel's wardroom. At 1325 ADM Larson was given a tour of the Defence Scientific Establishment (DSE), then returned to Wellington via RNZAFB Auckland. He departed New Zealand the following morning at 0900. Crossing the dateline once more, he arrived in Papeete, Tahiti, at 1610 on 13 April. Shortly thereafter, he met and dined with VADM Philippe Euverte, Joint Commander/Polynesia Commander, Pacific Nuclear Test Facility, and Commander in Chief, Pacific Maritime Area. The next day, ADM Larson had breakfast with him shortly before his 0900 departure. He arrived at HAFB at 1445 Thursday, 14 April.

(U) Elmendorf AFB, AK, 18-19 April: ADM Larson departed HAFB en route to Elmendorf at 0740 on 18 April. He arrived at 1515. About two hours later, he welcomed the SECDEF, the Honorable William J. Perry, to Alaska. Both proceeded to the SECDEF Conference in the Headquarters building for a three-hour meeting on Pacific Command (PACOM) issues. Shortly after the conference ended, ADM Larson flew back to HAFB and arrived at 0050 on 19 April.

(U) Washington, DC and NAS North Island, CA, 3-21 May: As was the norm for East Coast trips, departure from HAFB on 3 May was late night (2100 hours). He arrived at Andrews AFB at noon on 4 May. On 5 May he participated in the CNO ESC meeting at the CNA, discussing plans and policy issues, reviewing the status of Program Objectives Memoranda (POM) 96, manpower and personnel

UNCLASSIFIED

UNCLASSIFIED

issues, and the Leadership Training Continuum. In late afternoon he took a barge cruise of Washington Navy Yard. On 6 May, conference topics were Public Affairs issues, Base Realignment and Closure (BRAC), the Regional Maintenance Concept, and legislative issues. At 1400 he departed the conference for the State Department and met with Ambassador Winston Lord for about 30 minutes.

(U) Between 8-18 May, ADM Larson was on leave in Mayport, FL. He returned to Washington at 1055 on 18 May to attend the CINCs' Conference 18-19 May at the Pentagon. He began his trip home on 20 May at noon. After resting overnight at NAS North Island, he arrived at HAFB at 1145 on Saturday, 21 May.

(U) Naval Station Mayport, FL, Newport, RI, New York City, NY, 8-16 June: ADM Larson arrived at Naval Station (NAVSTA) Mayport at 1200 on 9 June. The next morning, he addressed officers from NAVSTA Mayport and Helicopter Antisubmarine Squadron Light Atlantic (HSL LANT). In the afternoon, he flew via H-3 to Cecil Field to visit a squadron and to address air antisubmarine squadron (VS) and strike fighter squadron (VFA) officers at the VS Officers' Wardroom. At 1400 on 12 June, he departed NAVSTA Mayport and was met upon arrival at Andrews AFB by the USCINCPAC Washington Liaison Officer, Lt Col Carl Critchlow, USAF.

(U) On Monday, ADM Larson spent the entire day at the Pentagon, and made calls on GEN Shalikashvili, ADM Jeremy M. Boorda, USN, CNO, and the SECDEF. At 1800 he departed Andrews AFB for Quonset Point State Airport, RI, and arrived at 1905. The next day he addressed the Naval War College Current Strategy Forum. He departed Rhode Island on 15 June en route to the US Military Academy, West Point, NY. He arrived at Stewart International Airport at 1040 after a 40-minute flight. He proceeded to the Superintendent's Quarters via helicopter and

UNCLASSIFIED

UNCLASSIFIED

arrived at 1100. After lunch with the Superintendent, LTG Howard G. Graves, USA, he and LTG Graves walked to Taylor Hall for a roundtable discussion with the Commandant, Dean, Brigade Tactical Officer (BTO), and Chief of Staff. Upon its conclusion, they walked to Ninninger Hall for a discussion about the Honor Code and System and the Honor Education System. That evening, he was LTG Graves dinner guest.

(U) Prior to his departure from West Point at 1330 on 16 June, he was involved in discussions of USMA's academic programs, faculty civilianization, consideration of others, and had lunch with cadets in the Okinawa Mess. He flew to Stewart International Airport via UH-1, boarded the VC-135 and arrived at HAFB at 1545.

(U) Japan and China, 4-8 July: ADM Larson's last trip as USCINCPAC was to Beijing, China, with an overnight stop at Kadena AB, Japan. He departed HAFB at noon on 4 July and arrived at Kadena AB at 1645, 5 July. He resumed his trip to Beijing the next morning at 0900. Upon arrival at 1120 he was met by MG Zhan Maohai, Deputy Director General of the Foreign Affairs Bureau (FAB) and Ambassador J. Stapleton Roy. After a country team meeting at the American Embassy, he called on General Xu Huizi, Deputy Chief of the General Staff, at the Ministry of National Defense, FAB, then participated in a combination welcome and working dinner hosted by General Xu.

(U) He spent most of Thursday, 7 July, at the 196th Infantry Division/24th Air Wing, returning to the FAB for a 1700 meeting with LTG Huai Guomo, Deputy Director, Commission on Science, Technology, and Industry for National Defense (COSTIND). At 1800, he called on Minister of Defense General Chi Hao Tian then dined with him at the Hepingman Roast Duck Restaurant. On Friday morning, he called on General Zhang Wannian, Chief of the General Staff, visited Tiananmen and toured the Forbidden City.

UNCLASSIFIED

UNCLASSIFIED

In the afternoon, he met twice with General Liu Huaqing, Vice Chairman of the Central Military Commission, then dined with him at the State Guest House. Shortly after the dinner, ADM Larson departed Beijing and arrived at HAFB at 1320 after a ten-hour-and-twenty minute flight. Three days later, on 11 July, ADM Larson passed command of PACOM to the Deputy CINC, LTG Harold T. Fields, USA. ADM Larson's next assignment was Superintendent of the US Naval Academy.

(U) Washington, DC and Elmendorf AFB, AK, 25-30 July: Although the actual assumption of command ceremony was scheduled for 1 August, ADM Richard C. Macke, USN, technically assumed command of USCINCPAC on 19 July and undertook this trip to Washington and Elmendorf as USCINCPAC. On Monday, 25 July he departed HAFB at 1900 for Andrews AFB and arrived the next morning at 1005. In the afternoon, he called on Senator Ted Stevens (R-AK). On Wednesday he called on Senators Daniel K. Inouye (D-HI) and Charles S. Robb (D-VA), and Representative Neil Abercrombie (D-HI). He had lunch with the Honorable James W. Wold, DASD for POW/MIA. Early the next morning ADM Macke departed Andrews AFB for Elmendorf AFB. When he arrived at 1115, he was met by Lt Gen Joseph W. Ralston, USAF, Commander Alaskan Command (COMALCOM). After a working lunch, he departed for the 90th Fighter Squadron (FS) where he received a briefing on OPLAN 5027. On Friday, 29 July, he participated in the ALCOM change of command ceremonies in which Lt Gen Lawrence E. Boese, USAF, relieved Lt Gen Ralston. The following morning he flew to Eielson AFB, AK where he was greeted by Brig Gen Ronald E. Keys, USAF, Commander, 354th Fighter Wing (FW). During his day-long stay at Eielson AFB, he received orientation briefings at the 18th, 355th, and 354th Fighter Squadrons (FS) which covered fighter, F-16, OA-10, and COPE THUNDER operations. He departed Alaska at 1600 that afternoon and arrived at HAFB at 2020.

UNCLASSIFIED

UNCLASSIFIED

(U) Japan and South Korea, 6-11 August: ADM Macke departed HAFB at 1525 on 6 August for Yokota AB, Japan. Upon arrival at 1900 on 7 August he was met by Lt Gen Richard B. Myers, USAF, COMUSJAPAN. On Monday, 8 August ADM Macke attended a US Forces Japan (USFJ) Command Briefing at 0700 in the MacArthur Conference Room, USFJ headquarters, then at 1005, traveled via helicopter to Hardy Barracks. From there he proceeded to the US Embassy for an office call with Chargé D'Affaires Mr. Rust Deming and a country team briefing. In the afternoon, he attended an honor ceremony at the Japan Defense Agency (JDA), called on Prime Minister Tomiichi Murayama, Administrative Vice Minister Shigeru Hatakeyama, and Gen Tetsuya Nishimoto, Japan Self-Defense Force (JSDF), Chairman, Joint Staff Council, and attended a Joint Staff Office (JSO) briefing by Gen Nishimoto. This very full day was topped off by a dinner at the Meijikinenkan hosted by Gen Nishimoto.

(U) The following day, he called on His Excellency Tokuichiro Tamazawa, JDA Minister of State for Defense, Mr. Atsushi Tokinoya, Director General, North American Affairs Bureau. He was the luncheon guest of Foreign Minister Masashi Kono, and following the luncheon, traveled via helicopter to Yokosuka for BLUE RIDGE (LCC 19). Once aboard, he was briefed by VADM Arthur R. Clemins, USN, Commander, US Seventh Fleet (COMSEVENTHFLT). At 1630, he departed Yokota AB en route to Osan AB, Republic of Korea (ROK), and was met upon arrival by Lt Gen Howell M. Estes, USAF, Deputy Commander, US Forces Korea (USFK) and RADM Edison L. Watkins III, USN, Commander Naval Forces Korea (COMNAVFORKOR).

(U) On Wednesday, 10 August, he met with GEN Gary E. Luck, USA, Commander USFK, at USFK headquarters building at Yongsan Garrison, Seoul, followed by a roundtable discussion with USCINCPAC and USFK representatives. He then traveled by helicopter to two sites north of Seoul, the Joint Security Area

UNCLASSIFIED

UNCLASSIFIED

(JSA) at Camp Bonifas and the Black Tactical Operations Center at Camp Red Cloud, for briefings and tours of the areas. Upon return to Seoul, he received a country team briefing moderated by Ambassador James T. Laney then attended a dinner hosted by GEN Luck at the Hartell House Annex.

(U) The next day ADM Macke visited and exchanged gifts with three ROK officials: the Honorable Rhee Byoung Tae, Minister of National Defense; GEN Lee Yang Ho, Chairman, Joint Chiefs of Staff; and GEN Chang Sung, DCINC Combined Forces Command (CFC). Late in the afternoon he visited the Ministry of Foreign Affairs (MOFA). ADM Macke departed Seoul en route to HAFB at 1800 on 11 August and arrived in Hawaii at 0800 on 11 August.

(U) Norfolk, VA and NAS North Island, CA, 13-18 Aug 1994: ADM Macke departed HAFB at 1920 on 13 August to attend the 15-16 August CNO CINC's Conference at the Armed Forces Staff College. During the day-and-a-half long conference, participants were briefed on issues such as: carrier battle group (CVBG) critical tasks, personnel tempo (PERSTEMPO), manpower issues, Navy Leadership Continuum, NROTC Nuclear Power Accessions, the Regional Maintenance Concept, POM/Budget update, readiness issues, adversary squadrons, and CONUS Joint Training. They also received theater briefs on USACOM, PACOM, and USNAVEUR. Immediately after the conference ended, ADM Macke departed NAS Norfolk for NAS North Island. Upon arrival he was met by VADM Jerry L. Unruh, USN, Commander, Third Fleet (COMTHIRDFLT), VADM David B. Robinson, USN, Commander, Naval Surface Force, US Pacific Fleet (COMNAVSURFPAC), and VADM Conrad C. Lautenbacher, Jr., USN, prospective COMTHIRDFLT. On Wednesday, 17 August, he attended the COMTHIRDFLT change of command and retirement ceremony aboard LAKE CHAMPLAIN (CG 57) and later toured the Naval Air Force, US Pacific Fleet facilities. Very early the next morning he had breakfast with VADM Lautenbacher, the new

UNCLASSIFIED

UNCLASSIFIED

COMTHIRDFLT, aboard his flagship, CORONADO (AGF 11). ADM Macke began his return to Hawaii at 0800 and arrived at HAFB at 1045.

(U) Fort Lewis, WA, Washington, DC, Okinawa, Alaska, Malaysia, Australia, and Guam, 12-24 September: At 2200 on 12 September ADM Macke began an extensive two-week journey throughout PACOM. Upon arrival at McChord AFB at 0630, 13 September, he was greeted by LTG C. Glenn Marsh, USA, Commanding General (CG) I Corps and Fort Lewis. ADM Macke immediately proceeded to Fort Lewis to begin a day-long orientation to the command. His visit included an I Corps Power Projection brief, a TEMPO BRAVE update, a visit to a Crisis Action Planning (CAP) Cell, an observation of 3rd Brigade with M1 and M2 systems overview, a windshield tour of base housing and facilities, and a dinner hosted by LTG Marsh.

(U) ADM Macke departed McChord AFB at 0800 on 14 September en route to Andrews AFB for a two-day stay in Washington, DC. After his 1530 arrival, he called on Ambassador Winston Lord, Assistant SECSTATE for East Asian and Pacific Affairs Bureau, at the State Department building and at 1900 attended a dinner in honor of General Tokuichiro Tamazawa hosted by the SECDEF, Mr. Perry.

(U) Thursday, he participated in the CINC's Conference at the Pentagon. Friday, he was interviewed by a reporter from Jane's Defence Weekly and attended a POW/MIA ceremony at the River Parade Field before taking off for Kadena AB via Elemendorf AFB, AK, at 1500. He spent two hours at the Officers' Club with COMALCOM while his plane was being refueled. ADM Macke resumed his trip at 2015 and arrived at Kadena at 2230 on Saturday, 17 September.

(U) During his one-day stop on Okinawa, ADM Macke conducted a visual reconnaissance of the US presence on Okinawa, including

UNCLASSIFIED

UNCLASSIFIED

Camp Lester, White Beach, Torii Station, and the Central and Northern Training Areas. He also received briefings on Quality of Life (QOL) issues and Okinawa land issues at the III Marine Expeditionary Force (MEF) Headquarters and on the 18th Wing and 10th Area Support Group (ASG) at 18th Wing Headquarters. He departed Kadena at 1515 for Kuala Lumpur.

(U) On Monday, 19 September, after receiving a country team brief and making official calls at the US Embassy, he gave the keynote speech at the Pacific Area Senior Officer Logistics Seminar (PASOLS) conference. He departed Kuala Lumpur at noon the next day en route to RAAF Fairbairn, Canberra, Australia. When he arrived at 2200, MG Connolly was there to greet him. On Wednesday, 21 September, after courtesy calls and country team discussions at the US Embassy, he traveled to the Russell Offices for a joint call on the Australian SECDEF, Mr. Ayers and ADM Beaumont, lunch hosted by the Chief of Defence Forces, and Defence White Paper discussions. He later traveled to the Australian Defence Force Academy to attend the reception for the upcoming Royal United Services Institute of Australia (RUSIA) International Seminar.

(U) RUSIA, a national body devoted to the study of strategy, national defence, and related matters, including military affairs in general, conducts International Seminars every three years. It was last held in 1991 and the US VCJCS, ADM Jeremiah, was the keynote speaker. The 22-23 September 1994 seminar, entitled "Regional Security in the Asia-Pacific: Toward 2001," was held at the Australian Defence Force Academy and the Honorable Paul Keating, Prime Minister of Australia gave the keynote speech. ADM Macke addressed the crowd of notables on 23 September. Many other distinguished invitees made presentations, including Brigadier (Ret) W. H. Grant, National President of RUSIA; General Try Sutrisno, Vice President of the Republic of Indonesia; Lieutenant General Ng Jui Ping, Chief of

UNCLASSIFIED

UNCLASSIFIED

Defence Forces Singapore; His Excellency Dato Zainal Abidan Bin Ibrahim, High Commissioner for Malaysia; and Mr. Gerald Hensely, SECDEF, New Zealand. Despite the full schedule of events, ADM Macke made time to call on Gareth Evans, Minister for Foreign Affairs, and Robert Ray, Minister for Defense. At 1800 on 23 September, ADM Macke departed for Guam.

(U) He arrived at Andersen AFB at 0540 on 24 September and began his day with an office call on RADM David L. Brewer, III, USCINCPAC Representative Guam (USCINCPACREP GUAM), at 0830. He received an executive summary of the Guam Land Use Plan (GLUP) and conducted a review of contested lands via CH-46 helicopter en route to Naval Station (NAVSTA) Guam. At NAVSTA, he took a windshield tour of the base and received briefings on QOL issues. He returned to Andersen AFB via CH-46 and then toured the Air Operations Center. After resting overnight at the Hilton, he departed Guam at 0825 on Sunday, 25 September. He arrived at HAFB at 2000 on Saturday, 24 September.

(U) Camp Pendleton, CA and Washington, DC, 3-8 October: ADM Macke arrived at NAS Miramar at 0610 on Tuesday, 4 October after a late-night flight from HAFB. He then embarked on a 20-minute UH-1 flight to Camp Pendleton where he was met by BGen Michael P. Delong, USMC, Deputy Commanding General (DCG), I Marine Expeditionary Force (MEF). After a breakfast with BGen Delong and other general officers, he proceeded to the I MEF conference room for a command briefing and discussions on I MEF planning and exercise issues, fleet exercises, and United Nations Operation Somalia (UNOSOM) support. This was followed by a visit to the 1st Surveillance, Reconnaissance, Intelligence Group (SRIG) Command Post where he viewed a SRIG Capabilities Exercise (CAPEX). Lunch was spent with firefighters and MEF officers followed by his last event of the day, a visit to the 1st Supply Battalion/1st Force Service Support Group (FSSG).

UNCLASSIFIED

UNCLASSIFIED

(U) The next morning, he departed Camp Pendleton by van and arrived at NAS Miramar in time for a 0800 flight to Washington, DC. He arrived at Andrews AFB at 1540 and later attended a dinner at the CJCS' quarters at Fort Myer. During the morning of 6 October, he attended the Security Consultative Meeting (SCM)-ROK conference at the CINC's suite and participated in an honors ceremony for the ROK CJCS at the Pentagon's River entrance. In the afternoon, he received a brief on the Precision/Rapid Counter Multiple Rocket Launcher Advanced Concept at the CINC's suite, then proceeded to the Rayburn building for a meeting with Representative Ronald V. Dellums (D-CA). During the evening, he attended a SECDEF hosted reception at the Anderson House.

(U) On Friday, after he was called on by Ambassador J. Stapleton Roy, US Ambassador to the People's Republic of China, he went on to participate in SCM-related events, including an open plenary session and a press conference and an ROK-hosted reception at the Arlington Ritz-Carlton Hotel. The following morning he departed Andrews AFB at 0800 and flew directly to HAFB, arriving at 1220.

(U) Philippines, 18-21 October: Many events were scheduled between 7 December 1991 and 2 September 1995 to commemorate the 50th anniversary of World War II. ADM Charles Larson, USN, USCINCPAC, had been designated as federal coordinator of the commemorative events in the Pacific in 1991 and had been deeply involved from the onset. ADM Macke continued in this role and flew to Manila on 18 October to participate in the ceremonies marking the 50th anniversary of the landing of allied troops at Tacloban, Leyte Island. He arrived in Manila on Wednesday, 19 October at 1600 and was greeted by Ambassador John Negroponte. The SECDEF arrived four hours later and ADM Macke returned to the airport to greet him.

UNCLASSIFIED

UNCLASSIFIED

(U) On 20 October the CINC flew to Taclobanan, Leyte Island, about 360 miles southwest of Manila. From there he traveled to MacArthur Park, the Leyte commemorative site, participated in the unveiling of the 50th Anniversary Leyte Landing marker, watched the commemorative landing reenactment ceremony, the Joint WWII Veterans Military Salute and stayed for a picnic lunch. He later attended the Ramos-SECDEF bilateral talks and took part in the Hill 120 flag-raising ceremony at which the SECDEF was the keynote speaker. Before returning to Manila, ADM Macke also attended a VIP reception aboard BELLEAU WOOD (LHA 3) and a reception hosted by President Ramos. ADM Macke departed Manila Airport at 1400 on 21 October, stopped for refueling at Andersen AFB, Guam, and arrived at HAFB at 0900.

(B)(1)(1.4d)

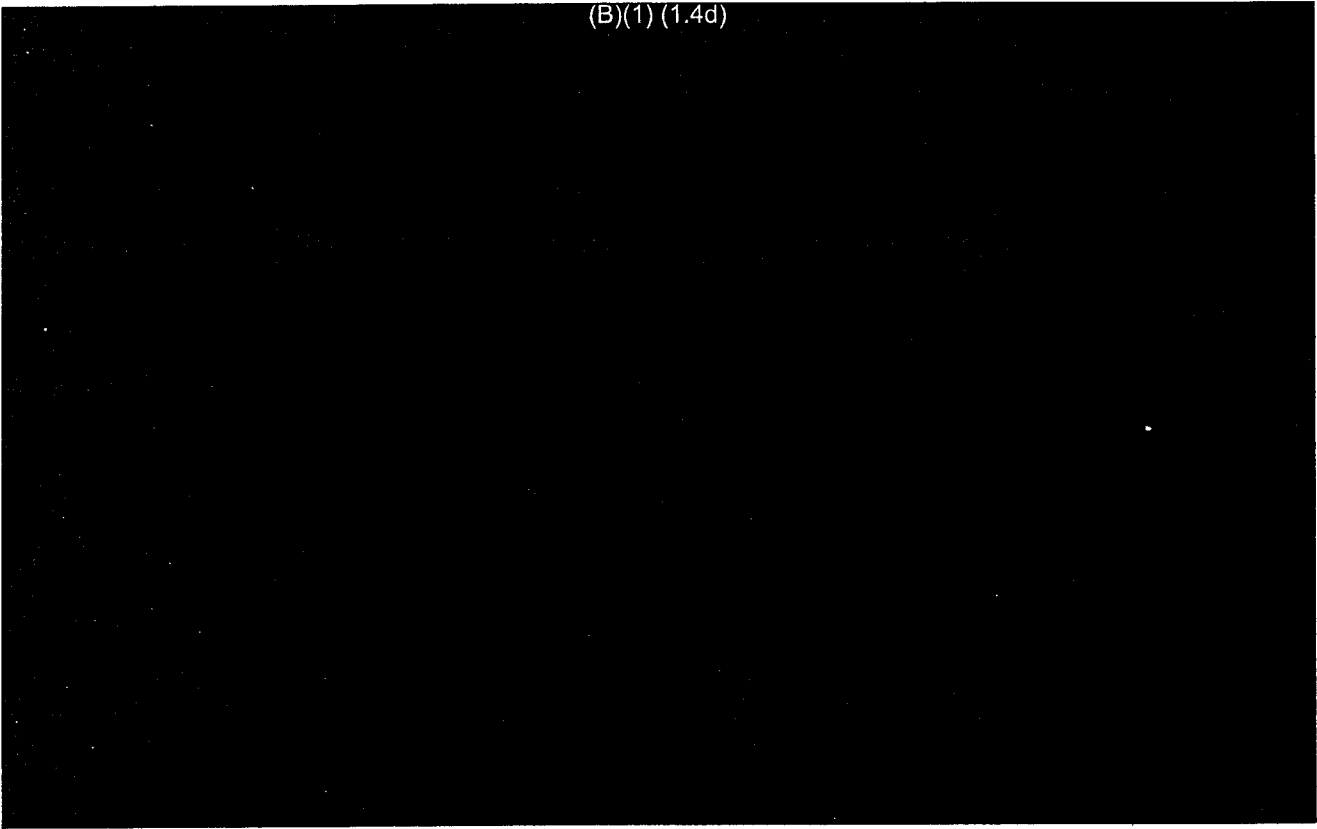

(U) ADM Macke's visit to two field sites, Quang Ninh and Hou Binh, filled the morning of 27 October; he flew out of Vietnam at 1500 for Vientiane, Laos. When he arrived at 1600,

UNCLASSIFIED

UNCLASSIFIED

Ambassador Victor L. Tomseth and LTC John J. Twohig, USA, Commander, JTF-FA Det 3, were on hand to meet him. ADM Macke later dined at the Ambassador's residence with the Ambassador and Laotian officials. At 1030 on 27 October, the CINC began his all-day trip to Joint Field Activity (JFA) sites (cases 1985 and 1284) in Laos. Most case sites were in very remote areas and these two were no exception. The first site in Luang Prahong province (case 1985) was a 90-minute helicopter flight away from Vientiane. The second in Xien Kohng province (case 1284) was about an hour's helicopter ride from the first. The sites were "literally in the middle of nowhere" and he noted that "No briefing...prepares you for how incredibly tough this work is and how formidable the logistics which support it." Upon return to Vientiane, he received further information about Det 3 efforts at a briefing and over dinner at the Det 3 Team House.

(U) On Friday he departed for Phnom Penh and was met by Lt Gen Ke Kim Yan, Royal Cambodian Air Force (RCAF) Chief of Staff (COS). After a Det 4 briefing, he checked in at the Cambodiana Hotel and where he received a CINCPACREP brief and had lunch with the US country team. He later met with the Cambodian Defense Co-ministers, the RCAF General Staff, and the Secretary of State for Foreign Affairs at their respective offices. Late in the afternoon he traveled to the US Embassy for a JTF-FA briefing and in the evening attended a reception at the Ambassador's residence. On Saturday, ADM Macke visited US demining trainers at Chom Chau RCAF camp, was the luncheon guest of the RCAF COS, and just prior to his 1300 departure for Bangkok was involved in a press conference at Pochentong Airport.

(U) He arrived in Bangkok at 1415 and proceeded to the Regent Hotel. At 1830, the Bangkok Defense Attaché hosted a dinner for the Admiral and his officers at the Defense Attaché (DAT) house. On Monday, 31 October, he had a country team meeting at the Ambassador's residence, followed by calls at the

UNCLASSIFIED

UNCLASSIFIED

Ministry of Defense (MOD), Ministry of Foreign Affairs (MFA), the Government House, the Supreme Command, the Royal Thai Air Force (RTAF), and the JTF-FA Det. The next day, he visited the Royal Thai Army (RTA) and Royal Thai Navy (RTN) Headquarters. He departed Thailand at 0630 on 2 November and rested overnight at the Hilton Hotel on Guam. He resumed his trip to HAFB at 0620 on 3 November and arrived in Hawaii at 1800 on 2 November.

(U) NAS Alameda and San Diego, CA, 9-14 November: ADM Macke flew from HAFB at 2359 hours on Wednesday, 9 November en route to NAS Alameda. At 1000 the next day he participated in the Joint Interagency Task Force West (JIATF WEST) change of command in which VADM Richard D. Herr, USCG, was succeeded by RADM John T. Tozzi, USCG. After the reception, ADM Macke flew to San Diego, arriving at NAS Miramar at 1400. That evening he was the guest of honor and guest speaker at the 219th Marine Anniversary ceremony at the Marriott Hotel. He was on leave for the next three days and left NAS Miramar at 0620 on Monday, 14 November. He arrived at HAFB approximately four hours later.

(U) Guam, India, and the Philippines, 7-16 December: A stop in Pakistan had originally been included but due to scheduling problems, the visit was canceled on 1 December. ADM Macke departed HAFB for his first visit to India as USCINCPAC at 0700 on Wednesday, 7 December. On his way, he stopped in Guam, arriving at 1050 on 8 December. He immediately departed on a 20-minute helicopter flight to BLUE RIDGE. After engaging in briefings and discussions with COMSEVENTHFLT and observing EXERCISE TANDEM THRUST, he returned by helicopter to Andersen AFB then his plane for India at 1445. On hand to greet him at New Delhi after his ten-hour flight were, among others, RADM Arun Prakash, Indian Assistant Chief of Naval Staff-Air and Commodore N. W. Joshi, Director of Naval Intelligence. At 2045, he proceeded to the Taj Palace Hotel where he rested overnight.⁵

UNCLASSIFIED

UNCLASSIFIED

(U) The morning of 9 December he met one Indian official after another at South Block: ADM V.S. Shekhawat, Chief of Naval Staff, Shri Deb Mukharji, Ministry of External Affairs (MEA) Additional Secretary, Shri Salman Haider, MEA Officiating Foreign Secretary, Shri Ka Nambiar, Defence Secretary, and Lt Gen Surinder Nath, Vice Chief of Army Staff. At 1230 he departed for Air Headquarters where he met with Air Chief Marshal (ACM) S.K. Kaul. He later returned to South Block for meetings with Shri Salman Khurshid, Minister of State for External Affairs and for a second meeting with ADM Shekhawat.

(U) On Saturday the CINC departed New Delhi for a four-hour visit to Jodhpur during which time he toured Indian Air Force (IAF) facilities and flew a familiarization sortie in a MiG 23UB. His next stop was Bombay where he was met by VADM K. A. S. Z. Raju, CINC, Western Naval Command. That evening, he was the guest of honor at the Western Naval Command's Navy Ball at the Taj Intercontinental Hotel.

(U) Monday, ADM Macke toured the Bombay Naval Base and visited an Indian Navy ship at the Mazgaon Dockyard Limited, hosted by RADM Gupteshwar Rai, Flag Officer Maharashtra Area. On Tuesday, 13 December, ADM Macke departed Bombay at 0900 for the Republic of the Philippines (RP) and arrived at Manila at 1830. The next day, following a US Embassy mini-country team brief and luncheon at Ambassador John Negroponte's residence, the CINC traveled via motorcade to Malacanang Palace where he met for a half-hour with President Ramos.

(U) On Thursday, the CINC traveled to Camp Aguinaldo via motorcade and met with GEN Arturo T. Enrile, Chief of Staff, Armed Forces of the Philippines (AFP), followed by a short trip by AFP helicopter to Villamor AB. From there he boarded the Joint US Military Assistance Group, Philippines (JUSMAGPHIL) C-12 for a 15-minute flight to Sangley Point, Cavite, where he visited

UNCLASSIFIED

UNCLASSIFIED

Philippine Navy Fleet facilities. His next stop was Basa AB, a half-hour away by C-12. He spent about an hour at Basa visiting the 5th Fighter Wing before boarding the C-12 for the flight to Fort Magsaysay where he had lunch at 7th Infantry Division (ID) Headquarters. He later visited 7th ID units and training areas and the Special Forces Camp.

(U) The RP-US Mutual Defense Board (MDB) met at Camp Aguinaldo, Quezon City, Metro Manila on 16 December. The purpose of the board is to encourage direct liaison and consultation between appropriate Philippine and US authorities on military matters of mutual concern and to develop and improve, through continuing military cooperation, the common mutual defense of the two countries. ADM Macke and GEN Enrile co-chaired the MDB. During this meeting, the board received an update on security assistance, discussed planning for EXERCISE BALIKATAN, discussed the exchange of mutually useful military information, and reviewed the work of the legal, planning, intelligence, and technical committees.. Afterwards, ADM was involved in the RP-hosted Friendship Games. At 1900 he departed Manila en route to HAFB, made a refueling stop at Andersen AFB, and arrived in Honolulu at 1315 on 16 December.

UNCLASSIFIED

UNCLASSIFIED

Distinguished Visitors and Local Events(U)

(U) A selected list of distinguished visitors to Hawaii received or greeted by USCINCPAC or Deputy USCINCPAC, attendance at local events, meetings with local news media personnel in Hawaii, and local speeches presented in 1994 is shown below.⁶

<u>Visitor/Event</u>	<u>Title/Location</u>	<u>Date</u>
Dr. Ning Hong Yeo	Minister of Defense, Singapore	3-6 Jan
ADM William A. Owens, USN	Vice Chairman, JCS	6 Jan
Hon. John H. Dalton	Secretary of the Navy	9-11 Jan
Mr. William F. Lackman	Director, Central Imagery Office	10 Jan
Gen Tetsuya Nishimoto, JSDF	Chairman, Jt Staff Council	11-12 Jan
Senators Daniel K. Inouye and Ted Stevens	US Senators Inouye (D-HI) and Stevens (R-AK), working lunch, CINC's dining room (CDR)	12 Jan
LTG Paul G. Cerjan, USA	President, National Defense University (NDU)	13 Jan
Mr. Lynn Pascoe	Director, American Institute in Taiwan	13-14 Jan
CINC's Initiative Fund Flag Review Group	Briefing, ECR	14 Jan
Kingdom of Cambodia Delegation	Orientation tours and briefings	17-21 Jan
LTG Orapan Watthanawibun, RTA	Royal Thai Jt Executive Director	18 Jan
COL Joshua L. Kiser, USA	Former Chief, Jt US Military Advisory Group, Thailand (JUSMAGTHAI)	20 Jan
Mr. Philip Barringer	Director, Foreign Military Rights Affairs, Office of the Secretary of Defense/Regional Security Affairs	19-20 Jan

UNCLASSIFIED

UNCLASSIFIED

Mr. Russell J. Wilson	Staff Director, House Foreign Affairs Committee	21-25 Jan
Brig Gen Mohd Ali Bin Wayat	Co-Chairman, Bilateral Training and Consultative (BITAC) Conference (Malaysia)	23-29 Jan
RADM William J. Hancock, USN	Director, CINC Liaison Div., Chief of Naval Operations (CNO)	25 Jan
Hon. James R. Woolsey	Director, CIA	22 Jan
Hon. Edwin Dorn	Under SECDEF for Personnel and Readiness	27 Jan-1 Feb
Interview	Los Angeles Times	31 Jan
Visit, International Officers, Air War College visitors	Briefings and discussions, CCBR	7-9 Feb
Hon. Brian Sheridan	Deputy Assistant SECDEF (ASD) for Drug Enforcement Policy and Support	7-9 Feb
Rand Researchers	Brief on Aerospace Power in Lesser Regional Crises, ECR	7-11 Feb
Hon. Richard Cheney	Former SECDEF	9 Feb
MG James M. Connolly, AA	Assistant Chief of Defence Force (Operations)	12-16 Feb
Amb. Walter Mondale	US Ambassador to Japan	13-15 Feb
Ms. Monica Chavez	Staff Delegate, Senate Armed Services Committee	13-16 Feb
Mr. Duarte A. Lopes	Director, Measurements and Signature Intelligence (MASINT), Defense Intelligence Agency (DIA)	14 Feb
Interview	Honolulu Star Bulletin, by Mr. Harold Morse	14 Feb
Japanese DIET mbrs: Hon. Ichiro Hino, Takashi Kosugi, Ryuichi Doi, Gen Nakatani, and Keiichi Ishi	Pacific Command Strategy briefings, roundtable discussions, CCBR	15 Feb

UNCLASSIFIED

UNCLASSIFIED

Governor Waihee, et al	Oahu Council dinner meeting at La Mer, Halekulani Hotel	16 Feb
Mr. Howard Rasmussen	Naval Research and Development (NRAD)	17 Feb
RADM John M. Luecke, USN	USCENTCOM J5	18 Feb
Depts of State and Interior, Jt Team	Discussions hosted by J5	21-22 Feb
ADM William O. Studeman, USN	Deputy Director of Central Intelligence	27 Feb-2 Mar
RADM Yasuko Sugiyama, JMSDF	Director of Operations, Jt Staff Office (JSO)	27 Feb-2 Mar
MG Donald F. Campbell and BG Robert A. Lucas, USA	US Army Reserve Command, US Army Civil Affairs and Psychological Operations Command; US Army Reserve Command, 351st Civil Affairs Command	27 Feb-2 Mar
Air Commodore Kenneth Gayfer, RNZAF	New Zealand Attaché	1-3 Mar
Mr. Ichiro Yoneyama	Director General of the Defense Facilities Administration (DFAA)	3-5 Mar
Mr. Murray Coban	Consulate General, Australia	4 Mar
Hon. Frank G. Wisner	Under SECDEF for Policy	4-6 Mar
Mr. George Findlay	Deputy Director, Counter Intelligence	5-7 Mar
Lt Gen Joseph W. Ralston, USAF, COMALCOM/11th AF, 11th AF Civic Leaders	JTF-FA and CINCPAC strategy briefs, J5 conference room	7 Mar
USCINCPAC Biannual Medical Conference	CCBR, J07	7-8 Mar
ADM Bruce Demars, USN	Director, Naval Nuclear Propulsion Program	11 Mar
RADM Francis W. Lacroix, USN	Deputy Director, JCS J-8	13-18 Mar
Telephone Interview	Honolulu Advertiser	14 Mar

UNCLASSIFIED

UNCLASSIFIED

Mr. Hon Yang, Sei Hoon	Consul General, Republic of Korea (ROK)	14 Mar
Amb. David Merrill	US Ambassador to Bangladesh	14-18 Mar
Hon. Kensaku Hogen	Consul General, Japan	15 Mar
Visit, CAPSTONE 94-1 Fellows	Tours, discussions, and briefs	15-18 Mar
Jefferson Fellows	Q & A, CCBR	16 Mar
The Consular Corps of Hawaii	Pacific Strategy Brief (PCSB), CCBR	17 Mar
Minister William Francis Birch	New Zealand Finance Minister	17-20 Mar
Governor's and Mayor's Prayer Breakfast	Hilton Hawaiian Village Hotel	18 Mar
Dato' Kamaruzzaman Bin Shariff	Secretary General, Malaysian Defense Ministry	18-20 Mar
Brigadier James A. Wright	Director, Jt Planning Staff, UK	20-23 Mar
Japanese Ministry of Foreign Affairs, Defense Agency, and Self-Defense Force	Political military games with Japan, US/Japan Conference	20-26 Mar
COL Thomas A. Swindell, USA	Chief, JUSMAGTHAI	22 Mar
MG David R. Hale, USA	Deputy Commanding General (CG), US Army Pacific (USARPAC)	22 Mar
Mr. Samuel P. Huntington	Eaton Professor of the Science of Government, Harvard, University, lecture at the East-West Center. J00 attended	28 Mar
USCINCPAC Commander's Conference	CCBR	29 Mar
ADM William J. Crowe, Jr., USN (Ret)	Breakfast meeting hosted by Pacific Forum/Center for Strategic and International Studies, 1001 Bishop St.	30 Mar

UNCLASSIFIED

UNCLASSIFIED

Mr. Oleg Lobor	National Security Advisor to President Yeltsin	1 Apr
ADM Thomas B. Hayward, USN (Ret) and Pacific Forum mbrs	Office call	1 April
Amb. Sandra Vogelgesang	US Ambassador to Nepal	1-5 Apr
RADM Harold E. Grant, USN, JAGC	Acting Judge Advocate General of the Navy	5 Apr
RADM William W. Mathis, USN	Deputy Commander, Military Sealift Command	7 Apr
Telephone Interview	Time magazine, by Mike Thompson	7 Apr
RADM Don B. Chalmers, RAN	Australian Maritime Commander (CNO)	7 Apr
VADM Prida Karasuddhi	Thai Supreme Staff, J4	7 Apr
Advanced Operational Arts Studies Fellows	Roundtable discussions	9-13 Apr
Dr. Ralph Neumann	Assistant Secretary Force Development, Australian Department of Defence	13-16 Apr
Hon. Togo D. West, Jr.	Secretary of the Army	14 Apr
Amb. Richard Melton	Office of the Inspector General, US Department of State	14-18 Apr
Honolulu Committee on Foreign Relations	Breakfast meeting, Kahala Hilton Hotel	21 Apr
Editorial Board	Honolulu Advertiser	26 Apr
Hon. Edwin Dorn	Under SECDEF for Personnel and Readiness	26-30 Apr
Amb. Josiah Beeman	US Ambassador to New Zealand	27 Apr-2 May
LTG Kahn, Noor Uddin, BA	Chief of Army Staff, Bangladesh	5 May
Mr. Sitiveni Rubuka	Prime Minister of Fiji	5 May

UNCLASSIFIED

UNCLASSIFIED

GEN Wayne A. Downing, USA	Commander in Chief, US Special Operations Command	11-12 May
MG Samuel A. Leffler, USA	Commanding General, US Army Information Systems Command	11 May
Mrs. Sue Ford Patrick	Director, Foreign Civil/Military Affairs, International Security Affairs, OSD	11-14 May
Mr. Alonzo Short	Director of Defense Informations Systems Agency	13 May
Hon. John Wood	New Zealand Ambassador to US	13 May
Mr. George R. Cramer	Veterans of Foreign Wars (VFW) Command in Chief	14 May
Hon. Kensaku Hogen	Consul General, Japanese Consulate	17 May
Major General Shuzo Hiyama	J2, Japan Jt Staff Office	19-20 May
Brig Gen Wilma Vaught, USAF (Ret)	President, Board of Directors for Women in Military Service for America	19 May
Mr. Donald M. Hearon Ms. Barbara S. Hinsley	National Commander, American Veterans (AMVETS) President, AMVETS Ladies Auxiliary	20 May
GEN Hikaru Tomizawa, JGSDF	Chief of Staff, Japanese Ground Self-Defense Force	23 May
Dr. Zbigniew Brzezinski with Dr. Michel C. Oksenberg	Professor, Johns Hopkins University Chancellor, East West Center	24 May
LTC John M. Sanderson, AA	Commander of Jt Forces, Australia	25-28 May
Staff and Students, National War College Republic of Korea	Briefings and discussions, J5 Conference Room	26-30 May
Japanese National Institute of Defense Studies	Pacific Command Strategy Brief (J5), ECR and Pearl Harbor tour	26-28 May
Brigadier Michael Caldwell, AA	Chief of Staff, Logistics Command, Australia	31 May- 3 Jun

UNCLASSIFIED

UNCLASSIFIED

Visit, CAPSTONE 94-2 Fellows	Tours, discussions, and briefs	1-3 Jun
Mr. Steven Cortese	Minority Staff Director, Senate Appropriations Committee	3 Jun
VADM Thomas Hughes, USN (Ret)	President and CEO Navy Federal Credit Union	3 Jun
Command and Control Interoperability Board 94-1	Discussions, J6 Conference Room	5-10 Jun
Amb. Charles W. Freeman, Jr.	ASD for International Security Affairs	6 Jun
Governor John Waihee	Reception for Chiefs of Mission Conference, Washington Place	6 Jun
ADM Alan C. Beaumont, RAN	Chief of Defence Force, Australia	12-15 Jun
BG Charles R. Viale, USA	Commander, JTF-FA	13 Jun
Commodore Terry Cole, RAN	Deputy Judge Advocate General, Australian Defence Force	15-8 Jun
BGen Carlton W. Fulford, Jr., USMC	Commanding General, III MEF	17 Jun
Korea Thinkpiece	ECR	20 Jun
RADM Tetsuya Nakama, JMSDF	Director of Logistics, J4, Jt Staff Office	20-23 Jun
RADM Don B. Chalmers, RAN	Australian Maritime Commander (CNO)	21 Jun
Mr. Masao Sadamitsu	Deputy Director, Communications Division, Japan Defense Agency	22-25 Jun
Emperor and Empress of Japan	Hickam Air Force Base, National Memorial Cemetery of the Pacific	23-24 Jun
Hon. James W. Wold	Deputy ASD (DASD) for POW/MIA	26-29 Jun
Interview	Honolulu Star Bulletin	28 Jun
Presidential Delegation for POW/MIA	CCBR	29 Jun

UNCLASSIFIED

UNCLASSIFIED

The Chamber of Commerce of HI Mil Affairs Council	J00's office	30 Jun
MajGen Peter Pace, USMC	Deputy Commanding General, Chief of Staff, USFJ	4-7 Jul
ADM Makoto Sakuma, JMSDF (Ret)	Former Chairman of the Joint Staff, Japan Self-Defense Force, J00's office	8 Jul
Air Commodore Alan Titheridge, RAAF	Director of Jt Planning, Australian Defence Force	9-15 Jul
GEN John Shalikashvili, USA	Chairman, Jt Chiefs of Staff (JCS)	10-11 Jul
ADM William A. Owens, USN	Vice Chairman, JCS	10-11 Jul
COL William McKinney, USA	DIA Defense Attaché, Korea	12 Jul
ADM Alan C. Beaumont, RAN	Chief of Defence Force, Australia	13 Jul
Hon. Noel R. Longuemare	Under SECDEF for Acquisition and Technology (Acting)	14 Jul
Maj Gen Kenneth L. Hagemann, USAF	Director, DNA	21 Jul
ASYMCA Board mtg	Hawaii Maritime Center	25 Jul
LTG Claude M. Kicklighter, USA (Ret)	WWII Commemorative IPR, CCBR	26 Jul
RADM David L. Brewer, USN	Prospective COMNAVMARIANAS/USCINCPACREP GUAM	28 Jul- 2 Aug
GEN John Shalikashvili, USA	Chairman, Jt Chiefs of Staff (JCS)	1 Aug
Mr. Murray Cobban	Consulate General, Australia	3 Aug
VADM Timothy W. Wright, USN	Commander, Seventh Fleet (COMSEVENTHFLT)	4 Aug
Dr. Allen Hawke	Secretary of the Australian Dept of Veterans' Affairs	4 Aug

UNCLASSIFIED

UNCLASSIFIED

VADM Archie R. Clemins, USN	Prospective COMSEVENTHFLT	5 Aug
COL William H. Jordan, USA and LTC Johnie E. Webb, USA	Central Identification Laboratory, HI	5 Aug
Hon. Bob Tyson	Minister of Congressional Liaison, Australian Embassy, Washington, DC	5 Aug
ADM Palasri, Pravidaya, RTN	Deputy Chief of Armed Forces Staff, Thailand	10 Aug
Dr. Alan Millett	Meshon Center, Ohio State University	11 Aug
Hon. Timothy Chorba	US Ambassador to Singapore	12 Aug
Dr. Barry Horton	Principal DASD (C3I)	15-18 Aug
Hawaii Military Land Use Master Plan Executive Summary	ECR	19 Aug
Hon. Wade R. Sanders	Asst. Under SECNAV for Reserve Affairs	19 Aug
Mr. Charles E. Symes	Director, Plans, Policy, and Programs (P3D) for Central Imagery	22-26 Aug
GEN Huizi Xu, CPLA	Deputy Chief of the General Staff	22 Aug
Hon. John Waihee	Governor of Hawaii	24 Aug
The Chamber of Commerce of HI Mil Affairs Council	ECR	25 Aug
RADM Edward K. Kristensen, USN	COMNAVMARIANAS/USCINCPACREP GUAM	26 Aug
RADM Howard B. Gehring, USCG	District Commander, Fourteenth Coast Guard District	29 Aug
ADM Ronald J. Hays, USN (Ret)	Former CINCPAC	29 Aug
Hon. Kensaku Hogen	Consul General, Japanese Consulate	29 Aug
Rep Patsy T. Mink	US Representative (D-HI), office call	31 Aug

UNCLASSIFIED

UNCLASSIFIED

Hon. James J. Hamre	SECDEF Comptroller	31 Aug
Gen Robert L. Rutherford, USAF	Commander, Pacific Air Forces (PACAF)	2 Sep
Policy review Subcommittee	US delegation, ECR	2 Sep
Mr. Jeremy Harris	Office call on the Acting Mayor of Honolulu, Honolulu Hale	2 Sep
Mr. Ian Cousins	Head, International Security Div., Dept of Foreign Affairs and Trade, Australia	2 Sep
Hon. Jeremy Harris	Acting Mayor of Honolulu, Honolulu Hale	2 Sep
Amb. Ray Caldwell	Deputy Asst. Sec. for Burdensharing, State Dept.	2 Sep
Ms. Sherrie Goodman	Deputy SECDEF for Environmental Security	6 Sep
ADM William A. Retz, USN	Commander, Naval Base (COMNAVBASE) Hawaii	6 Sep
CJTF Commanders' Conference	CCBR	7 Sep
ADM Norbert R. Ryan, Jr., USN	Asst. Chief of Naval Personnel for Distribution	8 Sep
LtG Jerome H. Granrud, USA	CG, USARJ/IX CORPS	8 Sep
Lt Gen Richard B. Myers, USAF	COMUSJAPAN	9 Sep
Maj Gen Edward V. Richardson, HIANG	Adjutant General, State of Hawaii	9 Sep
ADM Ronald J. Zlatoper, USN	CINCPACFLT	9 Sep
GEN Dennis J. Reimer, USA	Commander, Forces Command (FORSCOM)	12 Sep
Major General Xu Fan Ting, PLA	Dean of Studies, People's Republic of China, NDU	13-15 Sep

UNCLASSIFIED

UNCLASSIFIED

BG Patricia P. Hickerson, USA	Adjutant General, US Army	14 Sep
GEN Bipin Chandra Joshi, Indian Army	Army Chief of Staff, India	19 Sep
Mr. Frank Conahan	Asst. Comptroller General, US GAO	21 Sep
Maj Gen H. Hale Burr, USAF	ASD for International Affairs	23 Sep
Ms. Marilyn A. Meyers	Chargé American Embassy, Rangoon, Union of Burma	24-27 Sep
Dr. Joseph Holmes	DIA Representative	26 Sep
Hon. Yang Sei Hoon	Consul General of Korea	27 Sep
ADM Hugo White, RN	CINC, United Kingdom Fleet	28 Sep
Japan--America Society of Hawaii	General membership meeting, Sheraton Waikiki Hotel	28 Sep
Hon. James W. Wold	DASD for POW/MIA, ECR	29 Sep
Interview	Singapore Strait Times by Mr. Felix Soh, Editor	30 Sep
Hon. Stephen C. Joseph, MD, MPH	Assistant SECDEF for Health Affairs	30 Sep-1 Oct
BGen Kang, Sin-Kil, ROKMC	Chief Exercise Division, C-3, CFC	1-6 Oct
GEN Lee, Yang Ho	JCS, ROK	2-4 Oct
Ms. Debra Lee	ASD Reserve Affairs	3 Oct
Lt Gen Ng, Jui Ping	Singapore Chief of Defence Forces	3 Oct
MG Waldo D. Freeman, USA	CG, USARJ/IX CORPS	5 Oct
MG Thomas H. Needham, USA	Deputy COMALCOM	6 Oct
Mr. Neil Walter	Deputy Secretary, Ministry of Foreign Affairs and Trade, New Zealand	6-7 Oct
Dr. Robert Wood	Naval War College	11 Oct

UNCLASSIFIED

UNCLASSIFIED

Hon. Peter Reith and Mr. Murray Cobban	Mbr. of Parliament and Shadow Minister of Foreign Affairs, Australia Consulate General, Australia	11 Oct
Military Affairs and Advice Council, Greater San Diego Chamber of Commerce	PCSB, CCBR	13 Oct
RADM Robert Sutton, USN	Commander, Naval Ordnance Center	14 Oct
GEN John G. Lorber, USAF	Commander, PACAF	14 Oct
Japan Defense Society	CCBR	14 Oct
South Korean Ministry of Defense Press Corps	Question and answer session	15 Oct
VADM Robert K. Kihune, USN (Ret)	WWII Commemorative IPR, CCBR	17 Oct
Rep Robert A. Underwood	US Representative (D-GU), J01 office call	19 Oct
Hon. H. Allen Holmes	ASD for Special Operations/Low- Intensity Conflict	19-20 Oct
Hon. William J. Perry	SECDEF	21 Oct
Mrs. Steve Cortese	Minority Staff Director, Senate Appropriations Committee	21 Oct
MG Peter Arnison, AA	Land Commander, Australia	21-25 Oct
VADM Archie R. Clemins, USN	COMSEVENTHFLT	24 Oct
Mr. John Holum	Director, US Arms Control and Disarmament Agency	24 Oct
LTG Claude M. Kicklighter, USA (Ret)	WWII Commemorative IPR, CCBR	24 Oct
Dr. Frank Schwamb	Center for Naval Analysis (CNA) Representative	25 Oct
CAPSTONE 94-3 Fellows	PCSB, ECBR	26 Oct

UNCLASSIFIED

UNCLASSIFIED

Gen Chang, Sung	DCINC, Combined Forces Command (CFC), ROK	28 Oct
Mr. Tony Godfrey-Smith	Director, Defence Policy Section, Dept of Foreign Affairs and Trade, Australia	1 Nov
Mr. Noburo Hoshuyama	Director General, Defense Facility	2 Nov
General Tea Chamrath	Co-Minister of National Defense, Cambodia	2-4 Nov
Mr. Shigeru Musori	Director, Systems Analysis Office, Planning and Programming Division, Defense Policy Bureau, JDA	2-4 Nov
Senator Daniel K. Inouye	US Senator (D-HI), office call	3 Nov
Hon. Walter Slocombe; LTG Daniel W. Christman, USA; and Hon. Kent Wiedemann	Under SECDEF for Policy; Asst to the CJCS; and DASD for Asian-Pacific Affairs	4-5 Nov
Hon. James W. Wold	DASD for POW/MIA	5-8 Nov
MG William Kernan, USA	Director of Plans, Policy, Doctrine, and Combat Developments, Special Operations Command	5-8 Nov
MG Hong, Won Kil, ROKA	Assistant Chief of Staff, C4, CFC	5-8 Nov
Handa Wargame	USCINCPAC gaming facility	7-11 Nov
ROK civic leaders	PACOM brief, CCBR	8 Nov
MG Roger Thompson, USA	Commander, Military Traffic Management Command (MTMC)	8 Nov
Hon. Amata Kabua	President, Republic of the Marshall Islands (RMI)	9 Nov
VADM Philip M. Quast, USN	Commander, Military Sealift Command	11 Nov
Mrs. Helen Harsh and Mrs Helen Harvey	President and Chief of Staff, VFW Ladies Auxiliary	14 Nov
RADM Gordon S. Holder, USN	COMNAVBASE	14 Nov

UNCLASSIFIED

UNCLASSIFIED

USCINCPAC Commanders' Conference	Presentations, briefings, and discussions (CCBR)	14-20 Nov
Pacific Asian Affairs Council	40th Anniversary Jubilee, J00 keynote speaker, Hawaii Prince Hotel	15 Nov
AFCEA Conference	9th Annual Asia-Pacific International Conference, Sheraton Waikiki Hotel	15 Nov
USCINCPAC Commanders' Conference	CCBR	16-17 Nov
President William J. Clinton	Hickam AFB	16 Nov
Hon. Warren Christopher	Secretary of State (SECSTATE)	17 Nov
Air Commodore Bruce Wood, RAAF	Attaché Designate to Australian Embassy in Washington, DC	18 Nov
RADM John Tozzi, USCG	Director, Jt Interagency Task Force West	20-22 Nov
Brig Gen Huh, Kyoo Yull, ROKAF	Deputy Director of North Korea Bureau, KDIA	21-24 Nov
Messrs. James Gary and Daryl Gleed	President and Scout Executive, Aloha Council, Boy Scouts of America	23 Nov
Senator Stephen Loosley	Chairman of the Jt Standing Committee on Foreign Affairs, Defence, and Trade, Australia	28 Nov
LTG Robert L. Ord, III, USA	CG USARPAC	29 Nov
LTG C. Glenn Marsh, USA	CG I CORPS	29 Nov
RADM Thomas A. Mercer, USN	Superintendent, US Naval Postgraduate School	29 Nov-2 Dec
Dr. Frank Schwamb	Center for Naval Analysis (CNA) Representative	1 Dec
Hon. Ric Smith	Deputy SECDEF for Strategy and Intelligence	2 Dec

UNCLASSIFIED

UNCLASSIFIED

Gen Ronald R. Fogleman, USAF	Chief of Staff, US Air Force	2 Dec
VADM David M. Bennett, USN	US Navy Inspector General	2 Dec
Asia-Pacific Center	Briefing, CINC's booth	2 Dec
Hon. Kensaku Hogen	Consul General, Japanese Consulate	2 Dec
VADM Sir Somerford F. Teagle, RNZN	Chief of Defence Forces, New Zealand	4-6 Dec
Amb. J. Stapleton Roy	US Ambassador to China	5 Dec
Col Thomas Brown, USAF	Chief, Mutual Defense Assistance Office, Japan	5 Dec
Mr. Stanley Roth	Director for Asian Affairs, National Security Agency	6 Dec
Amb. Frances Cook	Deputy Asst. SECSTATE for Regional Security, Bureau of Political-Military Affairs	6 Dec
RADM Bruce Johnston, Canadian Forces (CF)	Commander, Canadian Maritime Forces Pacific	6 Dec
Mr. Jerry Bowen	Director Designate, National Cemetery System	6 Dec
Dr. Kenneth Flamm	Principal DASD for Economic Security	6 Dec
Mr. George Hyland	National President, Fleet Reserve Assn.	6 Dec
Pacific Command Security Assistance Conference (PACSAC)	Ilikai Hotel	7 Dec
Mr. Buzz Rizer	Director, Armed Forces Information Services	8 Dec
COL Mary L. Rupert, USA	Commander, Pacific Stars and Stripes	8 Dec
BG Vernon Conner, USA	Director of Plans, US Space Command	11-14 Dec
ADM Kim Hong Yoi, ROKN	ROK CNO	16 Dec

UNCLASSIFIED

UNCLASSIFIED

Mr. William Detweiler	National Commander, AMVET	16 Dec
VADM Romauld A. Waga	Commander of the Navy, Republic of Poland	19 Dec
Mrs. Linda Newsome	President, American Legion Auxiliary	19 Dec

UNCLASSIFIED

UNCLASSIFIED

SECTION II—INSPECTOR GENERAL ACTIVITIES(U)

Command and Control Inspections(U)

US Forces Korea(U)

(U) The USCINCPAC Deputy Inspector General (DIG) inspected command and control (C2) procedures at USFK from 4-8 April 1994. Twenty-one items and functions were inspected and the DIG team reported only two findings. Both the USKAC-D/E 2275 USFK Emergency Action (EA) Message Code Book and the USKAA-249 Non-sealed COMUSKOREA Telephone Authentication System were outdated and obsolete. USFK personnel had been using the code book four times longer than recommended by the National Security Agency (NSA). Additionally, the DIG suggested that changes in USFK mission might have eliminated the requirement for maintenance of a command-specific code system. In the case of the USKAA-249, the DIG recommended updating the system or replacing it with the USKAA-32.⁷

(U) In addition to communications, the DIG inspected training, operations, administration, watchstander proficiency, and security. The team made nineteen observations in areas such as: Communications Security, Command Center Training Programs, Alpha Team performance, EA Changeover Briefing, AUTODIN Message Receipt, EA Message (EAM) Processing, EA Message Handling, EA Message Voice Procedures, EA Checklists and Quick Reaction Checklists (QRC), and Uninterruptible Power Supply (UPS) and Emergency Power Plant (EPP).

US Forces Japan(U)

(U) The DIG reported great satisfaction with the C2 procedures at USFJ's Command Center. The DIG inspected 16 functions between 11-15 April. Performance was so impressive

UNCLASSIFIED

UNCLASSIFIED

that only four relatively minor changes were recommended. The DIG lauded several areas, particularly the Command Center Training Program. They felt USFJ should continue this excellent training program and assist subordinate units in achieving the same level of training.⁸

Commander Alaskan Command (U)

(U) This inspection of C2 procedures was conducted from 12 through 16 September at the Alaskan Command (ALCOM), Elmendorf AFB. In their review of 16 areas, the DIG found overall performance satisfactory. However, they found two repeat inadequacies at ALCOM. First, they cited the inadequacy of the AUTODIN Message receipt system, stating the communications systems could not process EA messages efficiently. They recommended coordinating with all agencies involved to obtain the necessary funding to install a direct AUTODIN inject-and-receive capability in the command center.⁹

(U) Secondly, they cited the absence of an UPS for the command center. When the command post was located in building 5-800, it had UPS. When it moved to building 11-530, the UPS remained behind. In August 1993, ALCOM submitted a work order requesting the UPS be moved from building 5-800 to 11-530. Despite its low cost (\$3,500.00), the project received low priority and the UPS was not moved. The DIG urged the installation of the UPS as soon as possible since the command center was responsible for USCINCPAC, ALCOM, North American Aerospace Defense Command (NORAD), PACAF, Eleventh Air Force, and 3 Wing (WG) actions.

Commander in Chief, US Pacific Fleet (U)

(U) The DIG reviewed CINCPACFLT's Command Center Emergency Action Procedures (CCEAP) from 26 through 30 September. Although

UNCLASSIFIED

UNCLASSIFIED

CINCPACFLT received only one finding out of the 16 functions reviewed, this was a repeat finding from the prior year. The DIG again observed that EA Checklists (EAC) were poorly constructed, not always followed, and the EA teams were not always familiar with the EAC.¹⁰

(U) Although other functions such as EAM Handling, EAM Processing, EA Voice Procedures, C2 Documents, and Emergency Evacuation Plan did not receive the label "finding," the DIG did not deem them faultless. Only Operational Reporting (OPREP-3) and Operations Security/Communications Security (OPSEC/COMSEC) were considered top-notch.

Commanding General, US Army Pacific(U)

(U) The DIG reviewed nine USARPAC C2 procedures between 14-17 November. Four were rated outstanding: EA Team Performance, EACs, EAM Processing, and the Command Center Training Program. Additionally, the DIG rated OPREP-3 reporting as "impressive" and the servicing COMSEC account was commended for its outstanding support. No findings were reported.¹¹

Commander, Pacific Air Forces(U)

(U) The DIG reviewed nine areas in PACAF's CCEAP from 28 November through 1 December. There were no official findings but the team did note a Periodic Investigation for one individual assigned to the C2 Center had not been accomplished. The problem was addressed immediately and an internal tracking system instituted to preclude future oversights. EA Controller Training and Standardization and Evaluation Programs, EA Team Performance, EAM Processing, C2 Documents, PACAF C2 Center COMSEC Account, and 15 CS COMSEC Account all received very high marks. The Staff Assistance Visit Program was also given high marks but the DIG

UNCLASSIFIED

UNCLASSIFIED

recommended increasing the frequency of visits. UPS was rated satisfactory.¹²

Performance Evaluation Group Reports(U)

(U) The DIG, in coordination with the Director of Logistics and Security Assistance (J4), had HQ USCINCPAC staff responsibility for the evaluation of Security Assistance Organizations. The Performance Evaluation Groups (PEGs) assisted the DIG in this effort. The PEGs were comprised of personnel from the Security Assistance Division (J45) with augmentation from other directorates and agencies as required.

India(U)

(U) In India, the Defense Supply Advisor (DSA) managed of security assistance sales and training programs. The PEG reviewed the efficiency and effectiveness of the programs between 24-26 January 1994. The PEG noted that while there was relatively little traditional security assistance (SA) activity in India, the DSA enhanced opportunities for establishing contacts with host nation military. This important service occurred through support of a number of non-SA functions in the area of military-to-military cooperation, such as Title 10 conferences and exercises sponsored under USARPAC's Expanded Relations Program.

(U) The DSA also spent much time working with US defense contractors marketing military equipment in India. The Embassy Chargé D'Affaires and the Foreign Commercial Attaché both fully supported the DSA in this effort.

(U) Management of the Resources, Training, and Automation programs were rated outstanding. In the area of Program Management, the PEG noted that DSA personnel did not maintain

UNCLASSIFIED

UNCLASSIFIED

continuity files. Although this omission was not a discrepancy, the PEG recommended the DSA establish such files to capture important information for successor DSAs.¹³

Thailand(U)

(U) From 25-29 April, the PEG evaluated the management of security assistance sales and training programs administered by the Joint US Military Advisory Group Thailand (JUSMAGTHAI). They reviewed ten functions and rated JUSMAGTHAI's efforts as excellent. One of the most daunting challenges JUSMAGTHAI faced occurred in Training Management. Since Congress had reduced International Military Education and Training (IMET) by 48 percent for FY 94, JUSMAGTHAI, as well as all other IMET program administrators, was faced with a severe shortfall. Fortunately, the Royal Thai Army (RTA) and Air Force (RTAF) requested three training-only Foreign Military Sales (FMS) cases to cover courses originally scheduled for purchase via IMET. This maneuver recovered training impacted by the \$925,000 Program Year (PY) IMET shortfall.

(U) The other nine functions (Mission and Organization, Security Assistance Program Management, Financial Management, Supply, Procurement, and Administrative Property Management, C-12 Management, Vehicle Management, Administration Management, Automation, and Medical Aid Station) were all rated at least satisfactory. Administration Management and Automation were rated as well managed. The team commented that the automated FMS suspense tracking system had application throughout the theater.¹⁴

UNCLASSIFIED

UNCLASSIFIED

Singapore(U)

(U) In Singapore, the SA function was administered by the SA Office (SAO). In 1993, the SAO had been formally separated from the Defense Attaché. The SAO Chief was made a member of the Embassy country team with full diplomatic status. This status granted him access to the senior levels of the Singapore military. This office also managed the SA program for Brunei.¹⁵

(U) The office handled 286 FMS cases with a value of approximately \$1,500,000,000. Although all supply deliveries had been completed in a number of these FMS cases, they had not been closed. This situation had been noted during the 1992 PEG review. The SAO was reminded to correct the situation. The PEG also found the SAO had violated US laws and USCINCPAC instruction 5510.10J by installing single copies of copyrighted software in all the office computers. The SAO was directed to work with USCINCPAC J45 to legally acquire and install Microsoft Office. Additionally, the PEG recommended pursuing the use of the Embassy local area network (LAN) to solve their data transfer and intra-office communication problems.

Nepal(U)

(U) The USDAO Kathmandu was responsible for both Defense Attaché Office (DAO) and SAO functions. The USDAO also conducted USCINCPAC-related responsibilities such as coordinating visits and exercises under Title 10 and USARPAC's Expanded Relations Program, serving as the point of contact (POC) for delivery of excess property under the Humanitarian Assistance Program, and disaster relief.¹⁶

(U) The PEG noted that since the USDAO was actually an asset of the Defense Intelligence Agency (DIA), both USCINCPAC and the Defense Security Assistance Agency (DSAA) had received

UNCLASSIFIED

UNCLASSIFIED

considerable benefit from the relationship. Since the DIA planned to close the USDAO by the end of FY 94, the PEG recommended that USCINCPAC and DSAA be willing to dedicate more attention and resources to Nepal if they wanted to maintain the current level of involvement. To this end, the country team and PEG agreed that the best office for handling SA responsibilities was the Political-Military (Pol-Mil) section in the Embassy. The PEG recommended the incoming Pol-Mil Officer receive appropriate SA training and orientations.

(U) The PEG also noted that USDAO had often conducted SA business in conjunction with DIA or other business. Expenses were then divided among relevant accounts. The PEG emphasized closure of the USDAO would shift all expenses to the SA account.

(U) The PEG praised Mr. Prem Singh's management of IMET and felt he was fully capable of shouldering responsibility for the program when USDAO closed.

UNCLASSIFIED

UNCLASSIFIED

THIS PAGE INTENTIONALLY LEFT BLANK

UNCLASSIFIED

UNCLASSIFIED

SECTION III—COMPTROLLER ACTIVITIES (U)

USCINCPAC FY 94 Operating Budget (U)

(U) Funds for USCINCPAC activities were provided through US Navy channels. FY 94 obligations for each category of funds are noted below in thousands of dollars:¹⁷

Table VII-1(U)

FY 94 OBLIGATIONS (U)

	General	WWMCCS	External	Support of	Special	General
	Purpose	GCCS	Public	Other	Operations	Defense
ORGANIZATION	Forces	C2	Affairs	Nations	Forces	Intelligence
HQ	23,274,773	2,844,000	72,000	3,373,000		8,254,000
ALCOM	1,200,000					620,000
CHMDO	349,000					
USF JAPAN	3,528,000	419,000				397,000
JTF--FA	13,900,000					
JIATF WEST	1,697,000					2,056,000
JUSMAGKOR	66,000					
JUSMAGTHAI	214,000					
JUSMAGPHIL	254,000					
CINCPACREPS	139,055					
JICPAC						25,168,000
COMSOCPAC					3,075,000	
TOTAL	44,621,828	3,263,000	72,000	3,373,000	3,075,000	36,495,000

Military Assistance Executive/Foreign Military Sales Trust Funds (U)

TABLE VII-2 (U)

T10 ADMINISTRATIVE EXPENSES (U)

Organization	FY-94 Obligations
HQ USCINCPAC	\$560,900

UNCLASSIFIED

UNCLASSIFIED

TABLE VII-3(U)

T20 SECURITY ASSISTANCE ORGANIZATION EXPENSES (IN DOLLARS) (U) :

ORGANIZATION	Flying Hours	For. Affairs Admin Support	Direct Obligations	FY-94 Total
JUSMAGKOR		\$169,000	\$2,585,800	\$2,754,800
JUSMAGPHIL	\$185,600	170,000	1,438,000	1,793,600
JUSMAGTHAI	167,300	49,200	1,583,600	1,800,100
OMADP Indonesia		164,200	627,500	791,700
MDO Japan		97,500	605,600	703,100
Malaysia		22,200	199,100	221,300
India		38,200	185,300	223,500
Australia		6,000	104,700	110,700
Singapore		14,300	135,000	149,300
Madagascar			45,900	45,900
Burma			3,500	3,500
Bangladesh		1,500	27,600	29,100
China			32,600	32,600
Sri Lanka		11,500	30,900	42,400
Nepal			21,100	21,100
Papua NG			10,700	10,700
New Zealand			9,900	9,900
Fiji		2,000	6,000	8,000
Total	\$352,900	\$745,600	\$7,652,800	\$8,751,300

TABLE VII-4(U)

OFFICIAL REPRESENTATION FUNDS(U)

Organization	FY 94 Obligations
HQ USCINCPAC	\$35,776
JTF-FA	2,250
COMUSJAPAN	35,000
USCINCPACREP Australia	362
USCINCPACREP Guam	1,096
USCINCPACREP Philippines	2,777
USCINCPACREP RMI	748
JUSMAG Thailand	1,295
COMSOCPAC	0
COMALCOM	2,196
TOTAL	\$81,500

UNCLASSIFIED

UNCLASSIFIED

TABLE VII-5(U)

MAP REPRESENTATION ALLOWANCE(U)

Organization	FY 94 Obligations
JUSMAG Korea	\$7,500
JUSMAG Philippines	4,300
MDO Japan	3,900
JUSMAG Thailand	5,600
OMADP Indonesia	3,200
India	800
Australia	700
Malaysia	400
Singapore	600
Sri Lanka	200
Madagascar	300
Bangladesh	200
China	0
Nepal	200
TOTAL	\$27,600

TABLE VII-6(U)

EMERGENCY AND EXTRAORDINARY EXPENSES FUNDS(U)

Organization	FY 94 Obligations
HQ USCINCPAC	\$ 5,471
JICPAC	655
COMUSJAPAN	11,681
TOTAL	\$17,807

FY 94 Funding Adjustments(U)

(U) There were no significant O&M,N reductions for FY 94. An additional \$776,000 was received from the CNO (09BF) in September 1994 to fund deferred real property maintenance projects, fully fund Joint Task Force—Full Accounting requirements and provide additional

UNCLASSIFIED

UNCLASSIFIED

funding for Headquarters C2S2 support. Security Assistance T-20 funding was initially reduced by \$1,057,000 (12.6%) due to downsizing initiatives directed by the Defense Security Assistance Agency (DSAA); however, an additional \$380,000 was restored to partially fund PCB clean-up requirements at JUSMAG Thailand.

Impact of Budget Adjustments(U)

(U) The reduction of Security Assistance funding placed a burden on existing O&M,N funding due to USCINCPAC's efforts to remain engaged in the AOR. There were increasing demands to expand the number of USCINCPAC Representatives in the theater due to the decrease of the Security Assistance presence.

UNCLASSIFIED

UNCLASSIFIED

SECTION IV—PUBLIC AFFAIRS(U)

(U) Because of space limitations, only selected activities of the Public Affairs staff agency are included in this section. The full range of reported affairs activities for this year and previous years is maintained in the USCINCPAC historical archives.¹⁸

Media Operations(U)

(U) Selected news releases produced by media operations during 1994 are described below in chronological order. Announcements concerning POW/MIA matters are covered in Operations, Chapter III. USCINCPAC visits and prominent visitors to the headquarters are listed in "Official Activities of the Commander in Chief," Section I of this Chapter.

- (U) On 4 January, EXERCISE PITCH BLACK was announced to the media. This aerial exercise was conducted between 26 July and 13 August near Darwin, Australia. The air forces of Australia, the Republic of Singapore, and the US participated.

- (U) On 11 January, EXERCISE KEEN EDGE was announced. KEEN EDGE was the eighth joint/bilateral command post exercise involving Japanese Self-Defense Force and US Forces. It was conducted 26 January—4 February 1994 and was headed by GEN Tetsuya Nishimoto, Chairman of the Japanese Joint Staff Council, and Lt Gen Richard B. Myers, USAF, COMUSJAPAN.

- (U) On 2 February, the 12 February Joint Intelligence Center Pacific (JICPAC) change of command ceremony was announced. During the change of command, Col John T. Wington III, USAF relieved CAPT Lowell E. Jacoby, USN. CAPT Jacoby had been tapped for promotion to Rear Admiral and was

UNCLASSIFIED

UNCLASSIFIED

slated to assume charge of the Intelligence Directorate at USCINCPAC.

- (U) On behalf of the US, ADM Larson signed the Acquisition and Cross Servicing Agreement (ACSA) between the US and Malaysia on 18 March. The agreement facilitated reciprocal logistics support between the two countries and was to be used primarily during combined exercises, training, deployments, operations, or other cooperative efforts, and for unforeseen circumstances or exigencies. The signing was conducted at USCINCPAC Headquarters and was open to the media.

- (U) On 12 April the USCINCPAC change of command was announced as being scheduled for 2 May. Also released that day was the announcement of a briefing on the PACOM plans for End of World War II Commemorative Events. The briefing was held at 1030 on 15 April at USCINCPAC Headquarters and was open to the media.

- (U) On 21 April a CINCPAC news release stated SECDEF Perry made three announcements concerning the position of USCINCPAC. First, the President had nominated ADM Larson for retirement at his current grade. Second, that the President had nominated ADM Larson for immediate recall to active duty and reappointment to the grade of Admiral and assignment as Superintendent of the US Naval Academy. Third, he announced the nomination of ADM Stanley R. Arthur, USN, for assignment as USCINCPAC.

- (U) On 26 April, it was announced that the USCINCPAC change of command ceremony was postponed indefinitely. The postponement was attributed to delays in the confirmation processes of ADM Larson and ADM Arthur, including an unexpected Congressional recess held in conjunction with the federal observance of the death of former President Richard M. Nixon.

UNCLASSIFIED

UNCLASSIFIED

- (U) Japanese Emperor Akihito and Empress Michiko visited Hawaii between 23–25 June and the media was allowed to photograph their arrival, participation in a ceremony at the National Memorial Cemetery of the Pacific, and departure. The Public Affairs offices at the 15th Air Base Wing and USCINCPAC coordinated media involvement in these events.

- (U) On 6 July, ADM Larson met with senior Chinese military in the People's Republic of China to discuss military and regional security issues. His visit was announced to the media on 2 July.

- (U) The USCINCPAC change of command in which LTG Harold T. Fields, USCINCPAC DCINC, relieved ADM Larson was held on 11 July in a military-only ceremony at USCINCPAC Headquarters. The announcement was made on 5 July and stated that LTG Fields would serve as USCINCPAC until a nominee for USCINCPAC was confirmed.

- (U) On 27 July, it was announced that the formal assumption of command ceremony for USCINCPAC would occur on 1 August. During the ceremony, ADM Richard C. Macke, USN, took command of USCINCPAC from LTG Fields.

- (U) On 16 August, JO1PA3 announced that JICPAC had received the Joint Meritorious Unit Award on 20 June. The release explained that the award was rarely given in peace time and had been earned for exceptionally meritorious achievement between 1 July 1991 and 1 April 1994. RADM Lowell E. Jacoby, USN, USCINCPAC J2, presented the award to COL Wigington, USAF, Commander, JICPAC, in a ceremony in the JICPAC auditorium on 1 August. The release explained the award had been earned for coupling "forward thinking management with new, dynamic methodologies to meet increasing intelligence demands." Military

UNCLASSIFIED

UNCLASSIFIED

could wear the Joint Meritorious Unit Award Ribbon and civilians, the Joint Meritorious Unit lapel pin.

- (U) On 1 September, it was announced that a combined training exercise between Army engineers and Lao technicians would be held in Savannakhet and Khammouan, Laos, beginning 3 September. About 15 soldiers from Hawaii and Korea assisted Lao engineers and technicians with the installation of water pumps.

Community Relations(U)

(U) Selected community relations activities during 1994 are mentioned below chronologically.¹⁹

(U) The Honolulu March of Dimes' Walk—America recruitment breakfast took place on 11 January at the Hibiscus Ballroom, Ala Moana Hotel. Two Marine Force Pacific (MARFORPAC) color bearers, two CINCPAC rifle bearers and the MARFORPAC Brass Quintet participated. On 17 January, a Joint Service Color Guard (JSCG) and the Commander in Chief, US Pacific Fleet (CINCPACFLT) band were part of the Martin Luther King parade in Waikiki. On 18 January, military personnel played in the Chamber of Commerce of HI—sponsored "Legislator's Golf Tournament" at the Navy—Marine Golf Course. On 27 January the 25th ID (L) Marching Band played in a Koko Head Elementary School parade promoting a Drug—Free Hawaii.

(U) On 3 February an 0—6 from each of the component commands played in the National Football League (NFL) Charities Golf Tournament at Ko'olina Golf Course. On 6 February a JSCG rendered honors at the Pro Bowl All—Star football game at Aloha Stadium. JSCG and single service color guards performed nightly during the 23—26 February run of the Navy Wives' Club fund—raising musical, Mardi Gras. On 26 February the military

UNCLASSIFIED

UNCLASSIFIED

supplied a dual-service color guard, military police dog demonstration, and an explosive ordnance demolition robot to the Honolulu Police Department (HPD) and Department of Education's "No Hope in Dope" events at Moanalua High School.

(U) On 2 March, two civilians from Hawaii were selected to participate in the Joint Civilian Orientation Conference. On 17 March the JSCG marched in the St. Patrick's Day parade organized by the Friendly Sons of St. Patrick.

(U) Approximately 160 high school students from the mainland, Alaska, and the Pacific Islands listened to Public Affairs Update (PAU) briefings on 4 and 11 April at the staff NCO Club, Camp Smith. A JSCG, the 25th ID (L) band, and a firing detail supported a 9 April ceremony at the National Memorial Cemetery of the Pacific (NMCP) honoring MIAs and former POWs. The next day, the JSCG, a firing detail, and a bugler participated in the 50th Anniversary Memorial Service of the 1399th Veterans Club at the cemetery. On 23 April, volunteers from all services, including 25 USARPAC rappellers, assisted in the annual Diamond Head clean-up.

(U) Volunteers from all services helped in the combined city and state anti-litter campaign between 2-13 May. Additionally, USARPAC supplied a CH-47 to assist with removal of abandoned vehicles from state lands at Kaena Point, Oahu. On 4 May a JSCG, firing detail, bugler, and Chaplain assisted the Lost Battalion Association in their conduct of a memorial dedication at the NMCP. A JSCG, the CINCPACFLT band, a firing detail, and a bugler supported the dedication of a plaque by the Veterans of Foreign Wars at the NMCP on 13 May. On 18 May MajGen M. T. Hopgood, USMC, CINCPAC J30, represented the command at the Hawaii Executives Council dinner meeting at the Kahala Hilton Hotel. He attended this meeting of key local business leaders to impress upon them the need for continued support of the military

UNCLASSIFIED

UNCLASSIFIED

in Hawaii. On 21 May, the HPD sponsored another "No Hope in Dope" event on Oahu. USARPAC supplied a marching unit and static display for the parade in Waianae. A combined military band concert was held on 21 May at the Waikiki Shell and the DCINC attended. On 22 May CINCPAC was represented by RADM Michael A. McDevitt, USN, J5, at the Chosin Few Memorial Dedication ceremony at the NMCP. A JSCG and the CINCPACFLT band supported a forum sponsored by the Aloha Chapter of the National Defense Transportation Association at the Hale Koa Hotel. On 29 and 30 May, a number of ceremonies were conducted in observance of Memorial Day. The ceremonies organized by the Friends of the Natatorium, Vietnam Veterans VFW Post 10583, the National Park Service, the State Office of Veterans' Services, and the Office of the Mayor received support from the armed services. Each event was supported by a JSCG and at least two of the following: buglers, saluting batteries, firing details, the PACFLT or MARFORPAC band, a choir, Chaplains, and escorts.

(U) For the King Kamehameha day floral parade on 11 June, the military supplied a JSCG, marching units, the MARFORPAC band, and a portable reviewing stand and chairs. On 24 June a JSCG, four-gun artillery salute battery, a 36-member honor guard company, 12 military police, a seven person firing detail, one wreath orderly, and the MARFORPAC band took part in the wreath-laying ceremony performed by the Emperor and Empress of Japan at the NMCP. The next day a JSCG and the MARFORPAC band performed in a Korean War Veterans' ceremony at the NMCP.

(U) On 15 July, approximately 30 Michigan State University students received a PAU hosted by J01PA in the CCB. Between 17-22 July, Maj Leonard M. Ryan, USMC, from J01PA assisted the Chamber of Commerce of HI Military Affairs Council members during their annual visit to the Pentagon and Capitol Hill. On 23 July, a JSCG, the MARFORPAC band, a salute battery and firing detail, and a Navy Chaplain participated in the commemoration ceremonies

UNCLASSIFIED

UNCLASSIFIED

for the 50th Anniversary of the Liberation of Guam. The Third Marine Division Association sponsored the ceremonies at the NMCP. On 24 July, a JSCG, a seven-person firing detail, and a flyover by two helicopters, UH-1 and AH-1, marked the dedication of Hawaii's memorials to the Korean and Vietnam Wars.

(U) A JSCG, the PACFLT band, and two wreath orderlies supported the annual Kyoto Kimono Memorial ceremony at the NMCP on 1 August. On 13 August a JSCG and the 25th ID (L) band took part in the Council of Samoan Chiefs and Orators' Flag Day ceremony at Keehi Lagoon beach park. On 27 August the USAF Thunderbirds conducted an air show off Waikiki.

(U) USCINCPAC designated USARPAC as the executive agent for coordinating military participation in Aloha Festivals week, 16-24 September. Events culminated with a parade on 24 September; a JSCG and marching bands participated.

(U) The Combined Federal Campaign kick-off rally was held at the Aloha Stadium on 4 October and was supported by a JSCG. On 15 October the HPD sponsored a "No Hope in Dope" parade in Honolulu and the 25th ID (L) band participated. On 22 October the Navy marked its 219th birthday with a Ball at the Hilton Hawaiian Village Hotel. The PACFLT band played the music.

(U) The Hilton Hawaiian Village Hotel was also the site of the USMC Birthday Ball. The Marines celebrated on 5 November and the MARFORPAC band provided the music. Earlier in the day, a JSCG and a 25th ID (L) band participated in the ribbon-cutting ceremony marking the opening of the Defense Finance and Accounting Service (DFAS) office in Bldg. 77 on Ford Island. Prior to the move, DFAS had been located in Bldg. 499 near Naval Station, Pearl Harbor. On 11 November, the Disabled American Veterans held a Massing of the Colors ceremony at NMCP and the military provided a JSCG, the PACFLT band, and a 21-gun salute by

UNCLASSIFIED

UNCLASSIFIED

the 25th ID (L). At the Hawaii State Veterans Cemetery in Kaneohe, the Hawaii Office of Veterans Services Veterans' Day ceremony was supported by a JSCG and a 21-gun salute. On 19 November, MARFORPAC supported HPD's "No Hope in Dope" parade in Waimanalo by sending its band and a static display.

(U) Ben Cayetano, winner of the November 1993 gubernatorial elections, was inaugurated on 5 December. The Iolani Place ceremony was supported by a 100-member Joint Service Honor Cordon and five-member color guard carrying national and state colors and the governor's flag. The Hawaii National Guard's 105mm Howitzers fired a 19-gun salute and four of their F-15's did a flyover. On 7 December, the DCINC presented a floral wreath at the Commander, Naval Base (COMNAVBASE) Pearl Harbor, ceremony on the ARIZONA. A JSCG and a 21-gun salute by the 25th ID (L) rounded out the ceremony. The American Veterans wreath-laying ceremony at NMCP was supported by a JSCG, bugler, and rifle firing detail. On 8 December, a JSCG and the PACFLT ensemble participated in the Boy Scouts Aloha Council banquet at the Sheraton Waikiki Hotel.

UNCLASSIFIED

UNCLASSIFIED

SECTION V—LEGAL AFFAIRS(U)

Homosexual Policy(U)

(U) On 22 December 1993, the SECDEF issued final approval of the new Department of Defense (DOD) Homosexual Policy. The policy was to have taken effect on 5 February 1994. However, implementation had to be delayed due to statutory requirements. Eventually, the policy became effective on 28 February 1994. The new policy made it clear that accessions were conduct-based, i.e., applicants would not be asked about their sexual orientation but would be informed about conduct proscribed for military members, including homosexual conduct. Homosexual conduct was defined as "...bodily contact, actively undertaken or passively permitted, between members of the same sex for the purpose of satisfying sexual desires or any bodily contact that a reasonable person would understand to demonstrate a propensity or intent to engage in homosexual acts." In addition to bodily contact, a "statement by a member that demonstrates a propensity (a likelihood) or intent to engage in homosexual acts, such as declaring oneself to be homosexual or bisexual; or homosexual marriage or attempted homosexual marriage" was considered homosexual conduct.²⁰

(U) Despite efforts to make the new policy as clear as possible, questions continued to crop up. By 3 November, the Air Force had encountered a number of situations in which military personnel stated they were homosexual to avoid specific assignments or deployments or get out of military service. The Judge Advocate General (JAG) for the Air Force clarified that the policy did not prohibit a commander from initiating inquiries on a member who stated he or she was a homosexual, especially when the service member had received substantial benefits from the government. The Air Force had recorded five cases since the

UNCLASSIFIED

UNCLASSIFIED

implementation of the new policy; three involved medical school, another, law school, and the fifth, graduate school. In such cases, inquiries proved whether separation action was warranted or if the statements were false and had been made to avoid service.

(U) The highly charged issue of homosexuals' fitness for service coupled with concern for preservation of homosexuals' civil rights was expected to be contentious for months to come.

Terms of Reference for US-Philippine Legal Affairs Committee(U)

(U) Up until January 1994, the US-Philippine Legal Affairs Committee was chaired by the Staff Judge Advocate, Thirteenth Air Force and the Judge Advocate General, Armed Forces of the Philippines. This committee provided legal advice on the application, interpretation, and implementation of the US-Philippine Mutual Defense Treaty to the MDB. During the January MDB meeting, the board decided to change the US co-chairman to the Staff Judge Advocate, USCINCPAC. The Staff Judge Advocate, Thirteenth Air Force became the alternate US co-chair.²¹

Russian-American Seminar on the Law of the Sea(U)

(U) The USCINCPAC Staff Judge Advocate, CAPT Dennis L. Mandsager, JAGC, USN, participated in the 1994 Russian-American Seminar on the Law of the Sea in Moscow. Held from 23-26 August, considerable attention was paid to the US Freedom of Navigation (FON) Program, particularly operational assertions of navigation rights by US military ships, US military strategy, and oceans policy. Invitation to the conference was notable since it had been extended by the President of the International Maritime Law Association, Professor Anatoly Kolodkin, and Ambassador Igor Kolossovsky of the Ministry of Foreign Affairs.²²

UNCLASSIFIED

UNCLASSIFIED

SECTION VI—MEDICAL ACTIVITIES (U)

Biosafety Level 3 Laboratory (U)

(U) The US Army built the Biosafety Level 3 (BSL-3) laboratory at a cost of \$2,250,000 in 1988 to study specific disease entities on the Korean peninsula; no other building in PACOM had its capabilities. Once the Army had completed its studies, it planned to scrap the laboratory. The Naval Medical Research Unit Two (NAMRU-2), Jakarta, Indonesia expressed interest in acquiring the lab building since it would significantly expand NAMRU-2's research capabilities, provide ability to identify threat agents of military interest, and be able to provide reference lab support to other military labs and units deployed in PACOM.²³

(U) The project to transfer authority from Army to navy and relocate the unique laboratory from Korea to NAMRU-2 was first initiated in November 1993. In January 1994 USCINCPAC informed MG Richard T. Travis, USA, the Commander, US Army Medical Research and Development Command (CDRUSAMRDC) that NAMRU 2 personnel were still keenly interested in acquiring BSL-3. In February, USAMRDC stated the facility would be available for transfer on 1 March after removing the scientific research equipment from the BSL-3. USAMRDC also made it clear that they would not underwrite any of the costs associated with the transfer of the lab, site restoration, or any future costs. Despite the bilateral appeal, funding remained a barrier. CINC initiative funds (CIF) were requested to pay for the relocation.

(U) ADM Macke took command of PACOM on 19 July and by October, had reviewed the BSL-3 project request. In November USCINCPAC J07 announced that CIF funds were disapproved and any possibility of relocation lay with CINCPACFLT and Commander US Forces Korea.

UNCLASSIFIED

UNCLASSIFIED

(U) In November, USCINCPAC J07 informed CINCPACFLT and COMSEVENTHFLT that funding was available. By December, NAMRU-2 was in the process of developing a contract to disassemble the lab for shipment. This outcome was welcomed by COMUSKOREA since the site occupied by BSL-3 had been COMUSKOREA's site of choice for construction of a Special Operations Command-Korea (SOC-K) Secure Intelligence Facility. In April, NAMRU-2 advised of a funding shortfall. A new CIF request was approved to cover the shortages and all parties anticipated relocation of the building in 1995.

Naval Hospital Okinawa(U)

(U) The Naval Hospital Okinawa (NHO) was originally an Army hospital. In 1977, after 19 years of Army administration, the building was transferred to the Navy and became known by its current name. Over the years, the hospital provided essential medical services to Okinawa-based military personnel and their families as well as western-Pacific military personnel evacuated by air transport. Recently, however, the hospital had begun to deteriorate; the building was in need of constant maintenance.²⁴

(U) By September 1994, a proposal to replace the NHO with a new, 436,460-square foot, 116-bed building had been validated by the Office of the Assistant Secretary of Defense for Health Affairs (OASD HA). However, during his September tour of PACOM, ASD HA Stephen C. Joseph, M.D., M.P.H., visited the NHO. Upon his return to Washington, he scheduled a staff member to conduct a follow-up visit. The staffer and the Director of the Defense Medical Facilities Office presented their views about the need for a hospital of that size at the November USCINCPAC Host Nation Funded Construction (HNFC) Conference in Hawaii. Discussions about replacement size, funding, and local reaction were lengthy.

UNCLASSIFIED

UNCLASSIFIED

Dr. Joseph subsequently recommended eliminating the 37-bed substance abuse unit, thereby reducing the number of beds to 79 and building size to 396,405 square feet. He felt optimal coordination of health care delivery with the new Kadena Clinic would ensure no loss in quality of health care.

(U) The CINC issued a message on 3 December 1994 tasking COMUSJAPAN to conduct a review of funding options, replacement size, and both government of Japan and local reaction to the proposal by 1 February 1995. ADM Macke firmly stated his conviction to provide modern medical care to service members and their families.

Elmendorf AFB Hospital(U)

(U) The Elmendorf AFB Hospital was built in 1959 but was severely damaged just five years later by a strong earthquake. By 1992, three independent studies had been conducted investigating the hospital's ability to withstand another earthquake. The studies all concluded that the hospital would not survive another major earthquake.²⁵

(U) Congress approved FY 94 MILCON funds for a new hospital. The structure was to be built 700 feet east of the existing hospital. Approved as a combined Air Force (AF) and Veterans' Administration (VA) hospital, 92 of the 110 beds were designated as AF and 18 as VA. Plans also included five operating rooms and 44 dental treatment rooms. Phase I of the construction began in June 1993; all major utility connections and most of the site excavation work were completed by July 1994. Construction on Phase II began in October 1994 with completion anticipated in 1996.

UNCLASSIFIED

UNCLASSIFIED

Smoke-Free Workplace(U)

(U) On 9 March 1994, the DOD issued a new DOD smoking policy. This policy replaced the 1986 policy which had simply limited the areas in DOD facilities where people could smoke. The turnaround was prompted by scientific evidence which demonstrated that second-hand smoke carried a serious and substantial health risk. Both the National Institute for Occupational Safety and Health and the Environmental Protection Agency reported that second-hand smoke was a major source of harmful indoor air and a known cause of lung cancer, respiratory illness, and heart disease.²⁶

(U) The new policy banned smoking of tobacco products in all DOD work places, both domestic and international. It also stipulated designation of outdoor smoking areas when possible and provision of smoking cessation programs for all personnel. DOD strove to protect all its workers, both military and civilian, from involuntary exposure to tobacco smoke, and to enhance workers' health.

(U) On 8 April 1994, the DCINC issued the Headquarters Smoking Policy. All smoking was to be conducted outdoors and away from common points of ingress and/or egress into the workplace, including outdoor stairways and other restricted passages. Additionally, requests to designate certain outdoor areas for smoking were to be submitted via USCINCPAC J1 to the host command, Camp H. M. Smith.

Family Advocacy(U)

Alaska(U)

(U) Mrs. Gwendolyn R. Costello, J073, reviewed Family Advocacy Programs (FAP) in Alaska between 1-13 August. At

UNCLASSIFIED

UNCLASSIFIED

Elmendorf AFB, she recommended that the FAP offices, currently located in the hospital's former morgue, move to a dry, healthy location. At Eielson, the FAP had established a wide variety of programs to meet the special needs of living in and working under severe conditions. Services and programs addressed the problems of cabin fever, long hours of darkness, Seasonal Affective Disorder (SAD), isolated living conditions, high cost of living, and marital discord.²⁷

(U) Fort Greely, another isolated post, was suffering from a staffing shortage and limited resources. J073 suggested improved family advocacy screening before assigning personnel to Fort Greely. By contrast, the Work-Life programs at the Coast Guard Center at Kodiak offered a wide variety of family support programs. Treatment services were available through civilian contracts and the US Public Health Service.

(U) The most serious problems in Alaska were found at Fort Richardson and Fort Wainwright. Statistics at both these posts depicted significant increases in reported and substantiated child and spouse abuse cases.

Japan and Korea (U)

(U) Between 20 August and 23 September, J073 conducted FAP assessments of USFJ and USFK sites. In Japan, she visited Yokota AB, Misawa AB, Camp Zama, Naval Air Facility Atsugi, Yokosuka Naval Base, and Sasebo Naval Base. In Korea, Camp Humphreys, Taegu/Camp Carroll, and Osan AB were visited. Only selected findings are included here.

(U) At Yokota, she found an increase in seriousness of family advocacy cases as well as increased use of weapons in incidents of family violence. At the Naval Air Facility, Atsugi, organizational lines were tangled. The Director of the Family

UNCLASSIFIED

UNCLASSIFIED

Service Center (FSC) also carried the title FAP Officer; FSC's mission was to provide a variety of primary prevention and family support programs. With such differences in missions and functions, allowing one individual to wear both hats caused confusion among both staff and clients. J073 wanted to see the problem resolved. Another navy command, Yokosuka Naval Base, had also established a confusing FSC/FAP organizational relationship. Here, the FAP was subordinate to the FSC. J073 urged correcting the problem.²⁸

(U) At Sasebo Naval Base, coordination of FAP and Branch Clinic areas of responsibility was good. However, at the time of J073's visit, there existed an issue which affected everyone's lives. Water was in extremely short supply. On 1 September, COMUSJAPAN issued a message to USCINCPAC requesting denial of family member entry for 20 weeks or more due to drought conditions. Water rationing had begun in mid-July at Hario and on 3 September on the main base. By 16 September, the North (main base) and South (Hario) Reservoirs were respectively 28.50 percent and 28.80 percent full. To help ease the shortage, reverse osmosis water purification units (ROWPUs) were brought in and had produced 555,300 gallons of water by 16 September. Still, this was not enough. On 20 September the rationing schedule was changed. Water was available every day, but only for five hours one day and six hours the next.²⁹

(U) The military leadership knew full well the personal and financial hardships brought about by family separation but conditions in Sasebo were so extreme that the former was the better choice. Proposals were made to delay arrival of dependents into the Sasebo area for 20 weeks or more. On 22 September, USCINCPAC issued a message to CINCPACFLT stating support of this measure. Included was a recommendation to forward the request to Under SECDEF for Personnel and Readiness for approval. Permission for family members to enter Sasebo was

UNCLASSIFIED

UNCLASSIFIED

dependent on a number of factors, including the extent to which their shipment of household goods had progressed.

(U) In Korea, the lack of a clear chain of command between 8th Army and USARPAC and USCINCPAC adversely impacted even FAP operations. It complicated communication and scheduling efforts, even to the point of affecting J073's ability to complete all site visits. Yongsan Garrison, Camp Casey, Camp Humphreys, Camp Carroll, and Osan AB were visited. The problem of non-command sponsored status at the Army bases was a recurring theme. Some Army staff were also in dire need of FAP training.

Telemedicine at Tripler Army Medical Center(U)

(U) Improvements in technology enabled Tripler Army Medical Center (TAMC) to provide a very distant site, Kwajalein Island, with better service. Although quality care was available at the 15-bed Kwajalein Hospital, isolation from a major hospital created some drawbacks. Prior to video teleconferencing (VTC) and the specialized diagnostic capabilities it afforded, numerous evacuations had been conducted. By March 1993, Kwajalein physicians were able to show a patient's problem to doctors at TAMC via VTC. Within a year, TAMC conducted over 100 video teleconferencing consults with Kwajalein. Not only did these consults provide patients with expanded care and reduce the number of evacuations, it gave the medical staff at Tripler opportunity to become involved with many unique medical cases. VTC was tremendously beneficial to both patient and physician.³⁰

(U) In May 1994, the VTC was linked with the Air Force Video Teleconference Network. VTC capability was then extended to Elmendorf AFB, Yokota AB, Andersen AFB, Osan AB, and many ships within the US Pacific Fleet. Additionally, future USCINCPAC plans called for setting up 23 other sites for linkage with VTC. As beneficial as VTC was, it was just part of a

UNCLASSIFIED

UNCLASSIFIED

complex technological network in progress at PACOM. This network will be addressed in the 1995 Command History.

Biennial Medical Conference(U)

(U) RADM David S. Frost, USN, headed the two-day USCINCPAC Biennial Medical Conference at Camp H. M. Smith on 7 March. The conference provided participants with an update on PACOM medical readiness and related medical issues. Topics included Korean Peninsula perspectives, the Role of the JTF Surgeon in the USCINCPAC Two-Tiered Command and Control System, Humanitarian Assistance/Disaster Relief in the Pacific, and US Atlantic Command (USACOM) Support Role for PACOM Major Regional Contingency (MRC). Speakers included LTG Harold T. Fields, Jr., USA, Deputy CINC, who gave the opening remarks, RADM Harold M. Koenig, Director of Health Services Operations for ASD HA, RADM Frost, and RADM James H. Black, USN, Surgeon for USACOM. Attendees also toured the Central Identification Laboratory, Hawaii, and received a JTF-FA brief.³¹

UNCLASSIFIED

UNCLASSIFIED

FOOTNOTES FOR CHAPTER VII

¹ Material for this section was taken from J00 trip files and daily calendars, Protocol itineraries, J031 Congressional visitors log, and J032 HistSums for 1993.

² Msg (C), USCINCPAC to CJCS, "Trip report to the Philippines", 18-20 Jan 94" (U), 210700Z Jan 94 (SD 7-1); msg (C), AMEMBASSY Manila to USCINCPAC, "Official-Informal (U)", 18-20 Jan 94" (U), 250928Z Jan 94 (SD 7-2); msg (C), AMEMBASSY Manila to SECDEF, "Mutual Defense Board Meeting in the Philippines (U)", 250328Z Jan 94 (SD 7-3).

(b)(1)(1.4d)

⁵ Msg (U), USCINCPAC to CJCS, "USCINCPAC Absence (U)", 011800Z Dec 94 (SD 7-8); msg (U), USCINCPAC to SECDEF, "Proposed Public Affairs Guidance (PPAG)-Philippines-US MDB Meeting 94-2", 081830Z Dec 94 (SD 7-9).

⁶ USCINCPAC's daily schedules and visitor's schedules prepared by the USCINCPAC Protocol Office.

⁷ Rpt (U) J004 5040 Ser 22, "Report of Command and Control Inspection," 22 Apr 1994 (SD 7-10).

⁸ Rpt (U) J004 5040 Ser 23, USCINCPAC J004, "Report of Command and Control Inspection," 22 Apr 1994 (SD 7-11).

⁹ Rpt (U) DIG 5040 IG Ser: 41, USCINCPAC J004, "Report of Command and Control (C2) Inspection," 3 Oct 1994 (SD 7-12).

¹⁰ Rpt (U) DIG 5040 IG Ser: 50, "Report of Command and Control Inspection," 19 Oct 1994 (SD 7-13).

¹¹ Rpt (U) DIG 5040 IG Ser: 59, "Report of Command and Control Inspection," 21 Nov 1994 (SD 7-14).

¹² Rpt (U) J004 5040 IG Ser: 60, "Report of Command and Control Inspection," 6 Dec 1994 (SD 7-15).

¹³ Rpt (U) J45 5000 Ser 0478, "FY94 Performance Evaluation Group (PEG) Report on the Defense Supply Advisor (DSA), New Delhi, India", 15 Apr 1994 (SD 7-16).

¹⁴ Rpt (U) J01 5000 Ser 119-94, USCINCPAC J004, "USCINCPAC Performance Evaluation Group (PEG) Report on the Administration of the U.S. Security Assistance Program, Bangkok, Joint Military Assistance Group, Bangkok, Thailand (JUSMAGTHAI), Apr 1994," 1 Sep 1994 (SD 7-17).

¹⁵ Rpt (U) J45 5000 Ser 111-94, "FY1994 Performance Evaluation Group (PEG) Report on the Security Assistance Office, Singapore (SAO SINGAPORE)," 11 Aug 1994 (SD 7-18).

UNCLASSIFIED

UNCLASSIFIED

- 16 Rpt (U) J45 5000 Ser: 0485, "FY94 Performance Evaluation Group (PEG) Report on the United States Defense Attaché Office (USDAO) Kathmandu, Nepal," 15 Aug 1994 (SD 7-19).
- 17 Memo (U), J050 to J044, "Comptroller Input for USCINCPAC Command History", 24 May 95 (SD 7-20).
- 18 JO1PA3 News Releases (U) nos. 01-, 03-, 04-, 09-, 12-, 13-, 17-, 21-, 28-, 29-, 30-, 32-, 38-, and 40-94, various dates, (SD 7-21).
- 19 Rpt (U) J0324S, "Command History Input for the Community relations Division, Public Affairs Office" January-December 1994, various dates, (SD 7-22).
- 20 Msg (U), SECNAV to ALNAV, "Homosexual Policy," 272103Z Feb 94 (SD 7-45); msg (U), SECNAV to ALNAV, "Homosexual Policy," 251932Z Feb 94 (SD 7-46); Point Paper (U), AF/JAG, "DOD Policy on Homosexual Conduct," Jan 94 (SD 7-47); msg (U), HQ USAF to AIG 9336, "Implementation of the New Accessions Policy Concerning Homosexual Conduct," 252200Z Feb 94 (SD 7-48); Memo (U), HQ USAF/JAG, "Commander Inquiries on Members Stating They are Homosexual," 3 Nov 94 (SD 7-49).
- 21 HistSum (U), USCINCPAC J060 "Terms of Reference for US-Philippine Legal Affairs Committee," 2 Mar 94 (SD 7-50).
- 22 HistSum (U), USCINCPAC J06, "Russian-American Seminar on the Law of the Sea," 15 Sep 94 (SD 7-51).
- 23 Msg (U) COMSEVENTHFLT to CINCPACFLT//N45, "Biological Containment Lab Seoul Korea," 140535Z Dec 93 (SD 7-23); msg (U) USCINCPAC to CDRUSAMRDC, "Biological Safety Level Three Laboratory Relocation and Disposition," 251800Z Jan 94 (SD 7-24); ltr (U), Deputy Chief of Staff For Logistics, US Army Research and Development Command, to LTG W. W. Crouch, CDR EUSA, [BSL-3], 17 Feb 94 (SD 7-25); msg (U) USCINCPAC to COMUSNAVFOR KOREA, "Biological Safety Level Three Laboratory (BSL-3) Laboratory Relocation," 131800Z Oct 94 (SD 7-26); msg (U) USCINCPAC to COMUSKOREA, "Biological Safety Level Three Laboratory (BSL-3) Laboratory Relocation," 011830Z Nov 94 (SD 7-27); msg (U) CINCPACFLT to COMSEVENTHFLT, "Opportune Lift of Modular, Biological Safety Level Three Laboratory (BSL) 100630Z Dec 94 (SD 7-28).
- 24 Talking Paper (U), USCINCPAC J072, "Proposed Replacement of Naval Hospital Okinawa," 6 Sep 94 (SD 7-29); Information Paper (U), USCINCPAC J072, "Proposed Replacement of Naval Hospital Okinawa (NHO)," 30 Nov 94 (SD 7-30); Ltr (U), Stephen C. Joseph, M.D., M.P.H., ASD HA, to ADM R.C. Macke, USCINCPAC, "Replacement of US Naval Hospital, Okinawa," 22 Nov 94 (SD 7-31); msg (U), USCINCPAC to COMUSJAPAN Yokota AB JA, "Naval Hospital Okinawa," 030145Z Dec 94 (SD 7-32).
- 25 Information Paper (U), USCINCPAC J072, "Elmendorf AFB Hospital Replacement Project," 20 Jul 94 (SD 7-33).
- 26 Msg (U), SECDEF Washington DC to AIG 8775, "Special DOD News Briefing on Smoke-Free Workplace Policy," 091336Z Mar 94 (SD 7-34); Ltr (U), DCINC USCINCPAC to Distribution (USCINCPACINST 5605.1L), "Headquarters Smoking Policy," 8 Apr 94 (SD 7-35).
- 27 Rpt (U), USCINCPAC J073, "Trip Report 5-20 June 1994", undtd (SD 7-36).
- 28 Rpt (U), USCINCPAC J073, "Trip Report 20 August-23 September 1994", undtd (SD 7-37).

UNCLASSIFIED

UNCLASSIFIED

29 Msg (U) COMUSJAPAN to USCINCPAC, "Request for Denial of Family Member Entry Approval for 20 Weeks or More for Sasebo, Japan Area," 011730Z Sep 94 (SD 7-38); msg (U)CINCPACFLT to PACADMIN, "Request for Denial of Family Member Entry Approval for 20 Weeks or More for Sasebo, Japan Area," 130746Z Sep 94 (SD 7-39); msg (U) COMFLEACT Sasebo JA to COMNAVSURFPAC, "Water Rationing SITREP NR14," 160128Z Sep 94 (SD 7-40); msg (U) BUPERS to AIG NINE NINE THREE SEVEN, "Restricted Travel of Family Mbrs to Sasebo Japan," 160026Z Sep 94 (SD 7-41); msg (U) USCINCPAC to CINCPACFLT, "Request for Denial of Family Member Entry Approval for 20 Weeks or More for Sasebo, Japan Area," 022350Z Sep 94 (SD 7-42).

30 Information Paper (U), J073, "Telemedicine at Tripler Army Medical Center," undtd (SD 7-43).

31 Schedule (U), "USCINCPAC Biennial Medical Conference," 7-8 Mar 94 (SD 7-44).

UNCLASSIFIED

UNCLASSIFIED

THIS PAGE INTENTIONALLY LEFT BLANK

UNCLASSIFIED
398

UNCLASSIFIED

CHAPTER VIII(U)

SELECTED CHRONOLOGY 1994(U)

(U) This unclassified chronology was compiled primarily from Current History, Foreign Affairs, Department of State Dispatch, wire service clips, newspapers, and messages for 1994. Although many of the events were outside USCINCPAC's assigned area of responsibility, all either directly or indirectly affected the U.S. military force posture and/or political relationships in USPACOM and are therefore included. Additionally, this chronology covers Joint Task Force-Full Accounting activities for 1993 as well as 1994.

JANUARY

- 01 The US Pacific Command was activated on this date in 1947.
- 02-18 The 21st Joint Field Activity (JFA) in the Socialist Republic of Vietnam (SRV) was conducted during this period in 1993.
- 06 JTF-FA established a new Archival Research Team (ART) in Vientiane.
- 06-28 The 27th JFA in SRV was conducted.
- 12 Jan- JFA 94-3L was conducted in Savannakhet Province, Laos,
08 Feb in 1994.
- 14 Jan- JFA 93-3L in Laos was conducted during this period in
08 Feb 1993.
- 20 ADM Larson and General Lisandro Abadia co-chair US-Philippine Mutual Defense Board in Manila, RP.
- 21 Jan- JFA 93-3C was conducted in Cambodia in 1993.
23 Feb
- 29 Jan- USS HEWITT (DD 966) conducted a port visit to
03 Feb Newcastle, Australia. While there, the crew assisted in fighting a local brush fire.
- 29 Jan- USS SAN BERNARDINO (LST 1139) conducted a highly
04 Feb successful port visit to Kagoshima, Japan. This was the longest ship visit to western Japan in the past few years.

UNCLASSIFIED

UNCLASSIFIED

FEBRUARY

- 01-03 The US/Thailand Command and Control Interoperability Board 94-1 was hosted by the Royal Thai Air Force in Pattaya, Thailand.
- 03 President Clinton lifted the trade embargo against Vietnam.
- 03 On this date in 1994, the Senate confirmed Dr. William J. Perry as Secretary of Defense (SECDEF) to replace outgoing SECDEF Les Aspin.
- 04 The USCINCPAC Director of the Pacific Command Combined Interoperability Program (J65) met with the Thai Supreme Command's Director of Communications (LTG Vinai).
- 07 The Director of the USPACOM Combined Interoperability Program (CIP) met with members of the Armed Forces of the Philippines' General Command And Services to introduce the CIP and invite them to join the program.
- 07 Feb-18 Mar The only JFA conducted in Cambodia in 1994 occurred during this period.
- 08 Remains possibly of Americans killed in the Vietnam War arrived at Hickam AFB, HI, via C-141 for delivery to CILHI this date in 1994. The remains were turned over to the US on 7 February in Hanoi.
- 12 Col John T. Wiginton III, USAF, assumed command of the Joint Intelligence Center Pacific, replacing CAPT Lowell E. Jacoby, USN.
- 14-15 A US/Japan Technology Review Group meeting was held at Griffiss AFB, New York.
- 14-16 US-Australian Logistics Review Talks were held at Melbourne and Canberra, Australia.
- 14-19 A logistics survey team consisting of seven team members and led by the USCINCPAC Deputy Director for Logistics and Security Assistance visited Cambodia in response to an October 1993 American Embassy Phnom Pehn request for humanitarian assistance for Khmer Rouge defectors.
- 24 The Army Afloat Prepositioning Ships Mermorandum of Understanding was introduced to Thai Ministry of Foreign Affairs representatives.

UNCLASSIFIED

UNCLASSIFIED

25 Feb- The 22nd JFA in SRV was conducted during this period
23 Mar in 1993.

26 Feb- The 28th JFA in SRV was conducted during this period
22 Mar in 1994.

28 Effective date of new DOD Homosexual Policy.

MARCH

04-27 JFA 93-4L was conducted in Savannakhet Province,
Laos, during this period in 1993.

05 ADM Larson made a 2 hour re-fueling stop in Western
Samoa.

09 Mar- JFA 94-4L was conducted in Houaphan and Xiang Khouang
04 Apr Provinces, Laos, in 1994.

14 Repairs to the JRD III submarine fiber optic cable
between Gesashi, Okinawa, and Sasebo, Japan, were
completed and testing began prior to putting the
cable back into service.

16-25 The 20th annual Security Assistance Training Program
Management Review was held.

18 An Acquisition and Cross-Servicing Agreement between
the US and Malaysia was signed.

23 Mar- JFA 93-4C was conducted in Stung Treng, Ratanakiri,
07 Apr and Kratie Provinces, Cambodia, in 1993.

24-28 A delegation from the League of Families of American
Prisoners and Missing in Southeast Asia visited Laos.

APRIL

01 JICPAC received the Joint Meritorious Unit Award.

06 JTF-5 was disestablished and replaced by JIATF WEST.
RADM Martin H. Daniell, USCG, relieved RADM John L.
Linnon, USCG, as Director.

07-21 Exercise TEMPO BRAVE 94-1 was held.

10-13 ADM Larson visited New Zealand; first USCINCPAC since
ADM William J. Crowe, USN, who visited in July 1984,
to visit New Zealand.

UNCLASSIFIED

UNCLASSIFIED

- 11 Electronic Collateral Support System software was installed on the Sun SPARC Workstation, and users involved in message dissemination received initial training on 19 April.
- 11-15 The USPACOM Command and Control Automatic Data Processing Plans and Requirements Conference was held with the 1854th Combat Information Systems Squadron serving as co-host.
- 12-20 A Reception, Staging, Onward Movement, and Integration Seminar and exercise was held in Seoul, Korea.
- 13 Remains possibly of Americans killed in the Vietnam War arrived at Hickam AFB, HI, via C-141 for delivery to CILHI this date in 1994. The remains were turned over to the US on 12 April in Hanoi.
- 15 CAPT(P) Lowell E. Jacoby, USN, became the new USCINCPAC Director for Intelligence (J2).
- 15 The US Pacific Fleet was stood up on this date in 1907.
- 18-20 Presidential Emissary for POW/MIA GEN John W. Vessey, Jr., (USA, Ret), visited Vietnam to discuss progress of the MIA accounting effort.
- 18-21 US/Australia Command and Control Interoperability Board 94-1 held at HMAS Watson's Bay, Sydney, Australia.
- 20-21 The Pacific Intelligence Board met.
- 20-22 The mid-term Project Development Committee of the Pacific Area Senior Officer Logistics Seminar met in Kuala Lumpur, Malaysia.
- 21 Apr- The 29th JFA in SRV was conducted during this period
24 May in 1994.
- 21 SECDEF announced that ADM Larson had been nominated for retirement and subsequent recall to active duty as Superintendent of the US Naval Academy. ADM Stanley R. Arthur, USN, was nominated to replace him. Change of command was scheduled for 2 May 1994.
- 22 Apr- The 23rd JFA in SRV was conducted during this period
24 May in 1993.
- 22 Former President Richard M. Nixon died on Friday, 22 April, in New York City.

UNCLASSIFIED

UNCLASSIFIED

- 25-29 The annual USPACOM Information Systems Security Conference was held at Fort DeRussy, Hawaii.
- 26 The remains of SGT Frank Morales, USA, lost in Korea during the Chinese Communist Offensive in November 1950, were identified at CILHI and returned to the USAF Mortuary at Travis AFB.
- The previously announced change of command for USCINCPAC scheduled for 2 May was indefinitely postponed because of delays in confirmation of Admiral Arthur. Arthur later withdrew his nomination.
- 27 LTC J. M. Kendall relieved LTC E. Spohn as Commander, Det Three, JTF-FA, located in Vientiane, Laos.
- 27 Communications for Exercise COBRA GOLD 94 were activated 27 April through 4 May.

MAY

- A "Record of Discussion" was signed with Japan which established the US/Japan Interoperability Management Board.
- 01 The War Reserve Stocks - Thailand program was finally completed.
- 02 The reorganization of HQ USCINCPAC J03 was completed. The Public and Governmental Affairs Directorate was divided into three staff agencies: Protocol (J01P), Legislative Affairs (J01LA), and Public Affairs (J01PA).
- US/Republic of Korea Command and Control Interoperability Board 94-1 was held in Seoul Korea.
- 04 May- JFA 94-5L was conducted in Houaphan and Xiang Khouang
01 Jun Provinces, Laos, in 1994.
- 05 The remains of Cpl Terry A. Hoffman, USMC, previously listed as unaccounted for, were identified by CILHI. Hoffman was lost in Vietnam on 19 August 1968. His remains were recovered by JTF-FA.
- 05 While in Pearl Harbor, USS LAKE ERIE (CG 70) accidentally discharged two 20mm rounds while conducting routine maintenance on the port MT-22 CIWS. Probable fall of shot was approximately 5 nm distant in an undeveloped mountain area north of Aiea. Considerable media interest was created.

UNCLASSIFIED

UNCLASSIFIED

- 06 The SS PRESIDENT WASHINGTON was carrying hazardous materials while berthed pierside in Pusan, Korea. A fire began aboard the ship and raged for two days before it was brought under control. Personnel from USS MOBILE BAY (CG 53), USNS ANDREW J. HIGGINS (TAO 190), the Chinhae Fire Department, Camp Hialeah Army Fire Department, and the Military Sealift Command Pusan, Korea assisted in the fire fighting.
- 06 A Memorandum of Understanding between the US Navy and the State of Hawaii regarding the cleanup of Kaho'olawe was signed and recorded with the State of Hawaii Bureau of Conveyances.
- 07 In a ceremony held at Palauea Beach, Maui, Kaho'olawe Island was conveyed to the State of Hawaii in a ceremonial signing of the documents of conveyance.
- 08-28 JFA 93-5L was conducted in Savannakhet Province, Laos, during this period in 1993.
- 09 The transfer of the title (Quitclaim Deed) for Kaho'olawe Island was recorded with the Hawaii State Bureau of Conveyances in both English and Hawaiian.
- 09-11 The 1994 Australia-US Logistics Working Party meeting was held at Camp Smith, Hawaii.
- 24 The remains of Capt William K. Cogdell, USAF, previously listed as unaccounted for, were identified by CILHI. Cogdell was lost in Laos on 7 November 1967.
- 24 Message traffic, classified up through Secret, became available for all USCINCPAC personnel connected to the C2S2 LAN.
- 25 May- JDS TAKESHIO (SS 580) visited Pearl Harbor from 25 May
02 Jun to 7 June.

JUNE

- 06-09 The seventh US/Singapore Command and Control Interoperability Board was hosted by the USCINCPAC Combined Interoperability Division at Camp Smith, Hawaii.
- 07 Jun- JDS TAKESHIO (SS 580) visited Pearl Harbor from during
13 Jul this period.

UNCLASSIFIED

UNCLASSIFIED

- 08 Remains possibly of American servicemen lost in the Vietnam War arrived at Hickam AFB, HI via C-141 for delivery to CILHI his date in 1994. They were released to the US on 07 June in Hanoi.
- 14 The US Army stood up on this date in 1775.
- 21 The GI Bill of Rights became law on 21 June 1944.
- 21 Installation of the ESI Red Switch at USCINCPAC began.
- 23 Jun- The 30th JFA in SRV was conducted during this period
19 Jul in 1994.
- 23-25 Emperor Akihito and Empress Michiko of Japan visited Hawaii. They arrived at and departed from Hickam AFB.
- 24 Jun- The 24th JFA in SRV was conducted during this period
20 Jul in 1993.
- 30 JIATF WEST Director, RADM Martin H. Daniell, USCG, retired and was replaced by RADM Richard D. Herr, USCG.
- 30 6th Infantry Division (Light) was deactivated.

JULY

- 01 CAPT(P) Lowell E. Jacoby, USN, USCINCPAC J2, was frocked RADM.
- 05-10 Western Australian ports near Perth were visited by six ships of the CARL VINSON battle group, including three nuclear-powered warships. USS CARL VINSON (CVN 70) hosted a fly-out for senior local officials and the Consulate General's Fourth of July reception.
- 06-08 ADM Larson met with GEN Xu Huizi, Deputy Chief of General Staff, PLA, in Beijing, China.
- 07 MG Thomas Needham, USA, relinquished command of JTF-FA to Brig Gen Charles Viale, USA, in ceremonies at Camp Smith. MG Needham had commanded JTF-FA since its inception in January 1992.
- 08 Kim Il-Sung, President and supreme leader of North Korea, died.
- 11 LTG Harold T. Fields, USA, relieved ADM Charles R. Larson, USN, of command of USPACOM in a brief ceremony at Camp Smith. LTG Fields had been DCINC since 4 June 1991.

UNCLASSIFIED

UNCLASSIFIED

- 15 The US Senate confirmed ADM Richard C. Macke, USN, as USCINCPAC. He assumed duties effective 19 July 1994.
- 16 Jul- JFA 93-6L (Laos) was conducted in 1993.
16 Aug
- 17-23 The 1994 Spectrum Management Conference was held at the Ilikai Hotel in Honolulu, Hawaii.
- 19-23 USS ANTIETAM (CG 54) conducted a successful port visit to Sydney, Australia.
- 21-29 Combined US-Thai Logistics Exercise 37 (LOGEX 37) was held at Utapao Naval Base, Thailand.
- 22 LtGen Charles C. Krulak, USMC, took charge of COMMARFORPAC/CG FMFPAC. He replaced LtGen Henry B. Stackpole, USMC.
- 29 The National Emergency Airborne Command Post (NEACP) changed its name to National Emergency Airborne Operations Center.

AUGUST

- The JWICS Program Management Office extended the JWICS video teleconferencing capability to Osan AB and Camp Tango, Korea.
- 01 ADM Richard C. Macke, USN, USCINCPAC, formally assumed command in ceremonies at Camp Smith.
- 01 At ceremonies held in the JICPAC Auditorium, JICPAC received the Joint Meritorious Unit Award for exceptionally meritorious achievement from 3 July 1991 to 1 April 1994.
- 01-04 The US/Thailand Command and Control Interoperability Board 94-2 met in Honolulu, Hawaii.
- 2-8, 19- The Russian research vessel YUHMOREGEOLOGIYA conducted
22 Aug port calls in Honolulu during these periods.
- 03 Remains possibly of American servicemen lost in the Vietnam War arrived at Hickam AFB, HI via C-141 for delivery to CILHI this date in 1994. They were released to the US on 02 August in Hanoi.
- 03 The Pacific Command Strategy, formally known as Cooperative Engagement, was promulgated.
- 03-30 JFA 94-6L (Laos) was conducted in 1994.

UNCLASSIFIED

UNCLASSIFIED

- 06 ADM Ronald J. Zlatoper, USN, became CINCPACFLT, replacing ADM Robert J. Kelly.
- 09 The Logistics Cooperation Committee of the ROK-US Security Consultative Meeting conducted bilateral discussions in Hawaii.
- 09-10 The US-ROK Security Cooperation Committee met.
- 10 USCINCPAC hosted the US-ROK Defense Technological and Industrial Cooperation Committee meeting.
- 19 Aug- The 25th JFA in SRV was conducted during this period
20 Sep in 1993.
- 22 The remains of three American servicemen previously listed as unaccounted for were identified. The remains were repatriated from Cambodia and Vietnam in 1993 and 1994..
- 18 Aug- The 31st JFA in SRV was conducted during this period
20 Sep in 1994.
- 27 Five USCINCPAC J6 personnel assisted Johnston Island operations after Hurricane JOHN swept through the island.

SEPTEMBER

- Worldwide consolidation of the US Navy HICOM into the USAF Global HF System was completed.
- 06 Cutover to interim service from the Hickam Red Switch occurred.
- 13 The Korean People's Army repatriated remains reported to be those of 14 UN servicemen listed as killed in action/body not recovered, from the Korean War. Repatriation took place at Panmunjom. Remains arrived at Hickam AFB via C-141 on 14 September for delivery to CILHI.
- 14-17 USS KITTY HAWK (CV 63) and her battle group conducted a port visit to Pusan, Korea.
- 16 Remains believed to be of an American serviceman shot down near the Kuril Islands 7 October 1952 during the Cold War arrived at Hickam AFB via C-141 for delivery to CILHI. The remains were exhumed on Yuri Island on 2 September.
- 18 The US Air Force was established on this day in 1947.

UNCLASSIFIED

UNCLASSIFIED

- 19-24 The Pacific Area Senior Officer Logistics Seminar XXIII was held in Kuala Lumpur, Malaysia.
- 20 The remains of Lt Col Richard D. Smith, USAF, previously listed as unaccounted for, were identified and returned to the USAF Mortuary at Travis AFB. Smith was lost in Vietnam on 11 March 1965.
- 23 The US Senate confirmed MG David A Bramlett, USA, for promotion to lieutenant general and appointment as Deputy USCINCPAC.
- 27 LTG David A. Bramlett was promoted to that rank in ceremonies at Fort Shafter. He had assumed duties as DCINC on 23 September upon Senate confirmation.
- 29 Sep- JFA-5C was conducted in Cambodia during this period in
03 Nov 1993.

OCTOBER

- Cutover to a Personal Computer Message Terminal at USCINCPAC occurred.
- 01 End of the US Trust relationship with Palau. President Clinton made this proclamation on 27 September.
- 01 US Army Space and Strategic Defense Command assumed operation of Wake Island from PACAF.
- 04 The Oahu Civil Defense Agency announced the threat of a Tsunami hitting the island of Oahu at approximately 1030 this day.
- 06 Remains possibly of US servicemen lost in the Vietnam War arrived at Hickam AFB, HI, via C-141 for delivery to CILHI this date in 1994. They were released to the US on 5 October.
- 07 Oct- JFA 95-1L (Laos) was conducted during this period in
07 Nov 1994.
- 11-14 US/Republic of Korea Command and Control Interoperability Board 94-1 was hosted USCINCPAC J6 at Camp Smith, Hawaii.
- 12 PV2 Steven E. Paulus, USA, was killed during a live fire exercise at Schofield Barracks, HI. PV1 Theodore R. McClure, USA, was shot in the left wrist. They had been in the support team line of fire.

UNCLASSIFIED

UNCLASSIFIED

- 13 On this day in 1775, the US Navy stood up.
- 19 Oct- JFA 94-1L (Laos) was conducted in 1993.
12 Nov
- 15 Oct- The 32nd JFA in SRV was conducted during this period
15 Nov in 1994.
- 17-19 US/Australia Command and Control Interoperability
Board 94-2 held in San Diego, California.
- 18-19 The first ever in-depth USCINCPAC J4 Logistics
Conference was held on Oahu.
- 20 ADM Macke participated in 50th anniversary World War
II events at Tacloban, Leyte Island, RP.
- 21 Oct- The 26th JFA in SRV was conducted during this period
16 Nov in 1993.
- 21-25 USS CROMMELIN (FFG 37) conducted a successful port
visit at Osaka, Japan. The port of Osaka was seldom
visited by US warships.
- 25 The remains of four American servicemen previously
listed as unaccounted for were returned to the USAF
Mortuary at Travis AFB. The remains of nine other
USAF servicemen identified by group remains were also
returned.
- 30 Oct- USPACOM hosted the Seventh International Military
03 Nov Operations and Law Conference at the Sheraton Princess
Kaiulani Hotel in Waikiki. Attendees came from 17
foreign countries.
- 31 On this date in 1984, Indira Gandhi was assassinated.
- 31 Thai Prime Minister Chuan Leekpai informed Admiral
Richard C. Macke that Thailand. was rejecting a US
request to conclude an Army Afloat Prepositioning
Ships Memorandum of Understanding for basing these
ships in Thai waters.

NOVEMBER

Operations/Intelligence Workstations which provided
USCINCPAC with its first Multi-Level Security
capability were installed on the Joint Deployable
Intelligence Support System.

UNCLASSIFIED

UNCLASSIFIED

- 03 On 3 November 1993, President Clinton signed Presidential Decision Directive (PDD) 14 which provided the guidelines for a US Western Hemisphere Drug Policy.
- 07 Bolshevik Revolution, 1917.
- 08 On this day in 1775, the US Marine Corps stood up.
- 09 Nov- JFA 94-2C (Cambodia) was conducted in 1993.
17 Dec
- 09-10 The fourth annual Pacific Senior Communicators Meeting was held at Hickam AFB, Hawaii.
- 10 CJCS established the Global Naval Force Presence Policy (GNFPP) on 10 November 1993.
- 10 RADM John T. Tozzi, USCG, relieved RADM Richard D. Herr, USCG, as Director, JIATF WEST.
- 12 Enthronement of Emperor Akihito, 1990.
- 15 Exercise TANDEM THRUST 95, a short-warning, limited-power-projection field training exercise, was held 15 November through 15 December.
- 21 The remains of an American serviceman previously listed as unaccounted for, were identified and returned to the USAF Mortuary at Travis AFB. The name was withheld at request of the family.
- 28 Maj Tony A. Lowe, USAF, assumed command of Det Four, JTF-FA, in Phnom Penh, Cambodia. He replaced Lt Col Charles P. Clayton, USAF.
- 30 Remains possibly of US servicemen lost in the Vietnam War arrived at Hickam AFB, HI, via C-141 for delivery to CILHI. They were released to the US on 29 November.

DECEMBER

- The USPACOM Multi-Level Security capability was first tested during Exercise TANDEM THRUST 95.
- 01 Intelink achieved initial operational capability at USPACOM.
- 02 ADM Macke approved stand-up plans for the Asia-Pacific Center for Security Studies.

UNCLASSIFIED

UNCLASSIFIED

- 03 USS VANDEGRIFT (FFG 48) conducted a long-range MEDEVAC of a critically injured Japanese merchant seaman.
- 04-20 The last JFA (JFA 94-2L) in Laos during FY 93 was conducted.
- 04-20 JFA 95-2L (Laos) was conducted in 1994.
- 07 President Clinton declared 7 December 1994 as "National Pearl Harbor Remembrance Day" and asked all Federal departments, agencies, and organizations to fly the US flag at half-staff in honor of all Americans who died as a result of the attack on Pearl Harbor.
- 07 On 7 December 1993, 31 remains were repatriated by the KPA at Panmunjom. The remains were transferred to CILHI for subsequent processing for identification.
- 07-09 The 26th Pacific Command Security Assistance Conference was held at the Ilikai Hotel in Honolulu, Hawaii.
- 08-20 During this period, a JFA which was designated Trilateral JFA in SRV and JFA 94-2L (Laos) was conducted in 1993.
- 13 The new HQ USCINCPAC ESI Red Switch was officially accepted with the signing of the Test and Acceptance Report and an interim TS-SCI accreditation was granted through 5 September 1995.
- 13 The remains of three American USAF servicemen previously listed as unaccounted for from the Korean War were identified and returned to the USAF Mortuary at Travis AFB. The servicemen were crew members of a B-29 shot down over Sinuiju, North Korea, on 12 April 1951. Remains were repatriated by the KPA in December 1993.
- 13 The remains of CDR Edward F. Gold, USN, previously listed as unaccounted for, were identified and returned to the USAF Mortuary at Travis AFB. Gold was lost in Vietnam on 22 December 1965. Remains of a second serviceman whose name was withheld in deference to family wishes were also returned to the USAF Mortuary at Travis AFB at the same time.
- 21 In the final repatriation of remains for 1993, the KPA returned 34 sets of remains at Panmunjom on 21 December. The remains were transferred to CILHI for subsequent evaluation and attempted identification.

UNCLASSIFIED

UNCLASSIFIED

22

The first Joint Monthly Readiness Review (JMRR)
(pronounced "Jammer") was held.

UNCLASSIFIED

INTERNATIONAL DEFENSE COMMITMENTS IN THE U.S. PACIFIC COMMAND

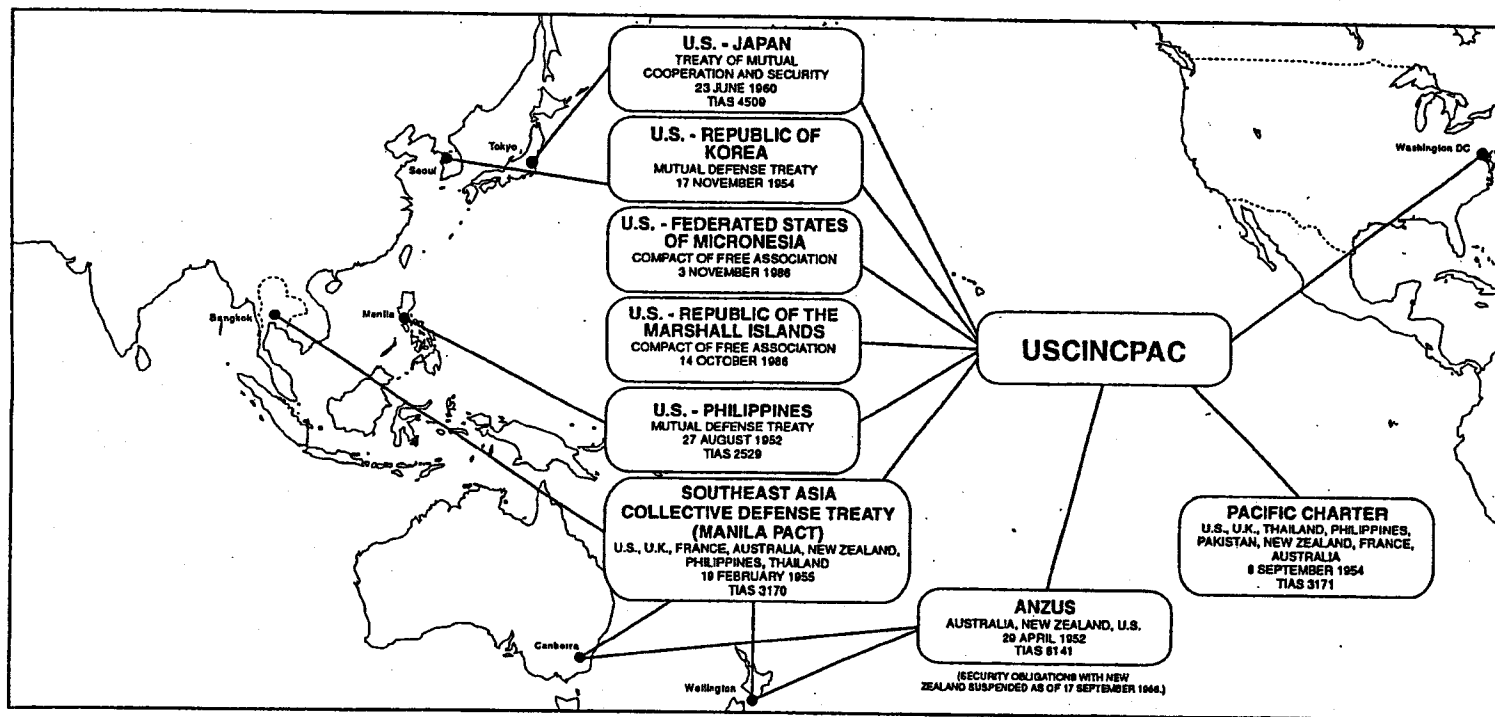

UNCLASSIFIED
413

UNCLASSIFIED
APPENDIX I
COMMAND STATUS

Classified by: US Pacific Command Digest(S/NF). Source marked OADR, dtd 15 Feb 1995.

THE U.S. PACIFIC COMMAND (U)

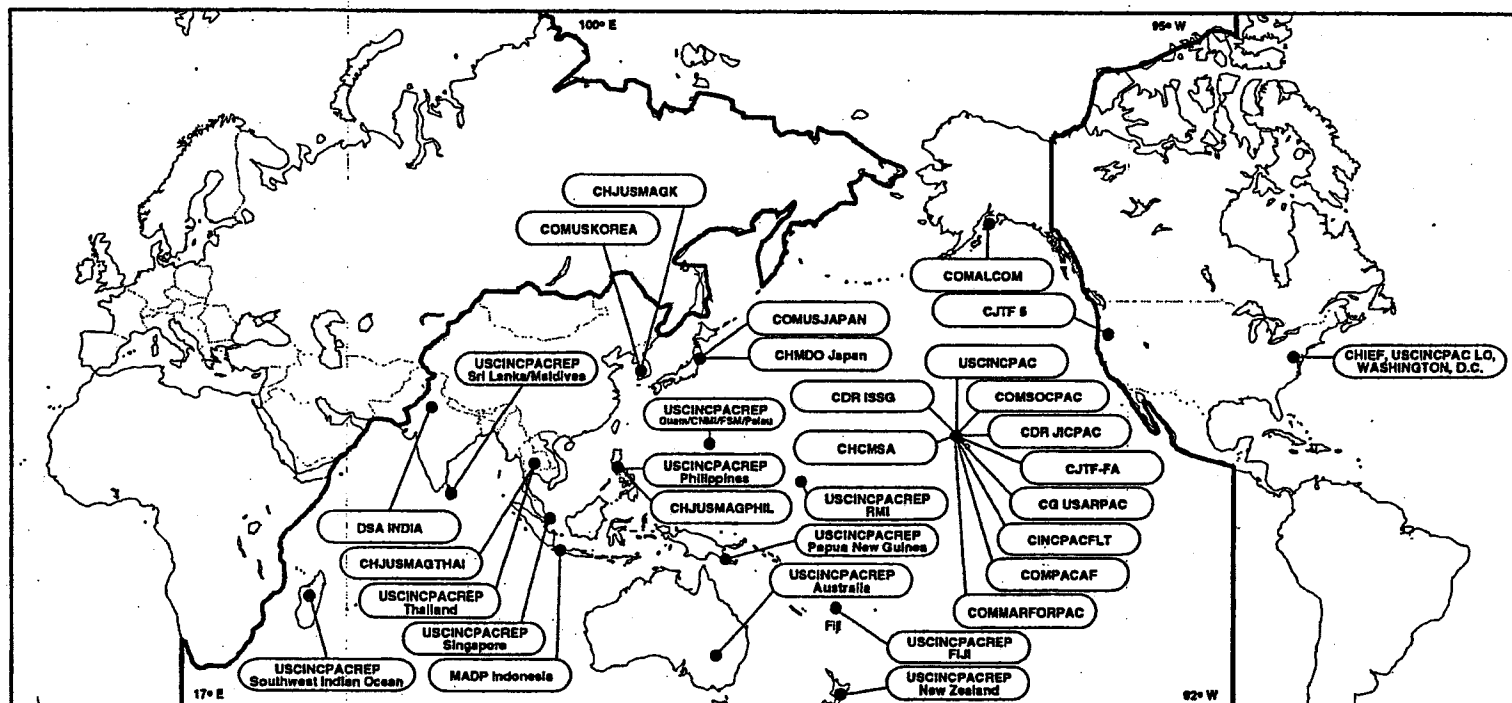

UNCLASSIFIED
414

UNCLASSIFIED

Classified by: US Pacific Command Digest(S/NF). Source marked OADR, dtd 15 Feb 1995.

COMMAND RELATIONSHIPS IN USPACOM

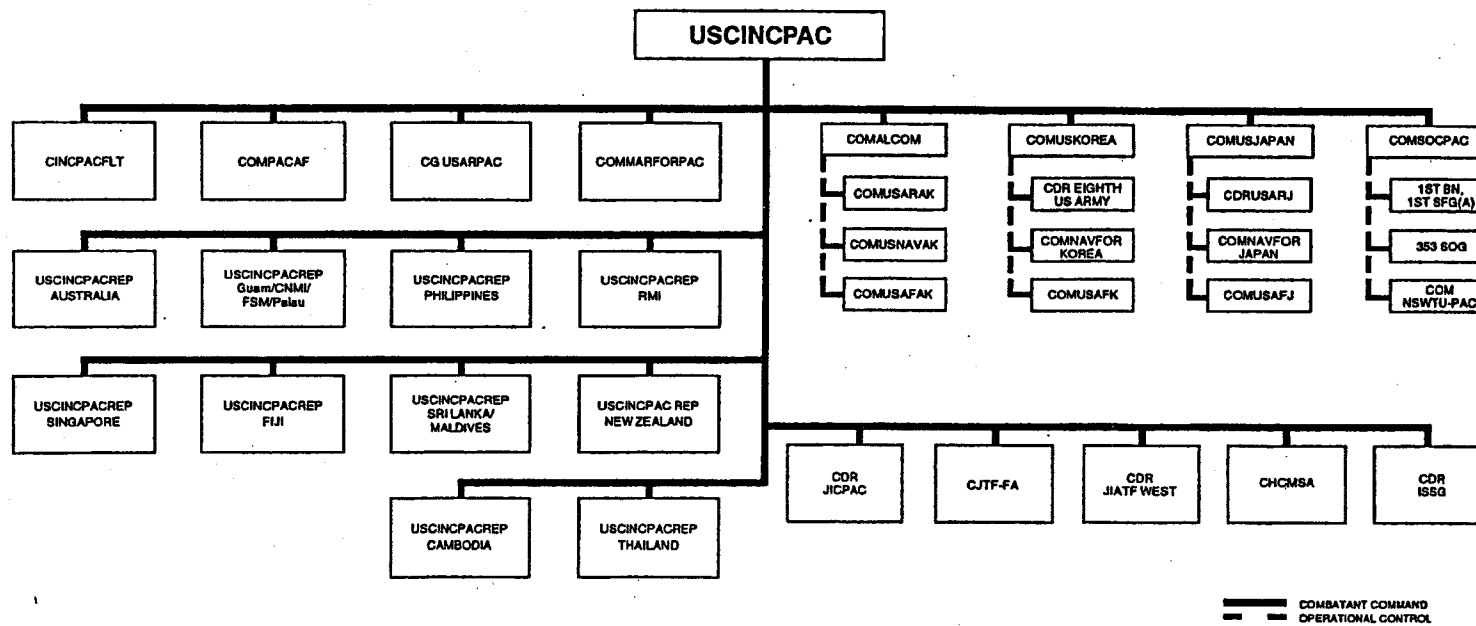

UNCLASSIFIED
415

UNCLASSIFIED

Classified by: US Pacific Command Digest(S/NF). Source marked OADR, dtd 15 Feb 1995.

COMMAND ORGANIZATION (U)

1. (U) COMMANDER IN CHIEF, U.S. PACIFIC COMMAND (USCINCPAC):

- a. (U) USCINCPAC is the commander of a unified combatant command whose mission is to:
 - Foster peace, democracy, and freedom throughout the Pacific Command
 - Protect and promote vital U.S. interests in the Pacific region by:
 - deterring conflict through forward presence and combat-ready U.S. and allied forces;
 - enhancing positive relations with all nations; and
 - strengthening political, economic, and security cooperation.
 - If deterrence fails, then achieve decisive victory at war.
- b. (U) The PACOM area of responsibility (AOR) is the Pacific Ocean west of 92 degrees west longitude, Alaska (excluding air defense), the Bering Sea, the Arctic Ocean west of 95 degrees west longitude and east of 100 degrees east longitude, the Indian Ocean east of 17 degrees east longitude (excluding the Gulfs of Aden and Oman), Japan, the Republic of Korea, the Democratic People's Republic of Korea, the People's Republic of China, Mongolia, the countries of Southeast Asia and the southern Asian landmass to the western border of India, and Madagascar and the other islands in all assigned water areas.
- c. (U) USCINCPAC exercises combatant command of Secretary of Defense-assigned or attached forces through the USFACOM Service component commanders, the commanders of subordinate unified commands, and the commanders of joint task forces.
- d. (U) USCINCPAC exercises administrative control over military agencies, offices, organizations, and commands which administer security assistance programs within the USFACOM area. COMUSKOREA, however, exercises administrative control over Chief, Joint United States Military Affairs Group, Korea (CHJUSMAGK). Additionally, USCINCPAC coordinates activities within the USFACOM area through established coordinating authorities who are designated United States Defense Representatives (USDRs) and/or USCINCPAC Representatives (USCINCPACREPs).
- e. (U) USCINCPAC is accredited as the U.S. military adviser or representative to the following organizations:
 - (1) (U) ANZUS Council: U.S. Military Representative.
 - (2) (U) Philippine-U.S. Mutual Defense Board: U.S. Military Representative and Co-Chairman.
 - (3) (U) U.S.-Japan Security Consultative Committee: Member and Principal Adviser on Military Defense Matters to the Chairman of the U.S. Representation.
 - (4) (U) ROK-U.S. Security Consultative Meeting: Delegate.
 - (5) (U) ROK-U.S. Military Committee, Plenary Session: Member.
 - (6) (U) FSM-U.S. Joint Committee Meeting: Senior U.S. Member.
 - (7) (U) RMI-U.S. Joint Committee Meeting: Senior U.S. Member.

2. (U) USFACOM SERVICE COMPONENT COMMANDERS:

- a. (U) Commander in Chief, U.S. Pacific Fleet (CINCPACFLT).
- b. (U) Commander, Pacific Air Forces (COMPAFAF).
- c. (U) Commanding General, U.S. Army Pacific (CG USARPAC).
- d. (U) Commander, Marine Forces Pacific (COMMARFORPAC).
- e. (U) The USFACOM Service component commanders are responsible for accomplishing such operational missions and tasks as may be assigned by USCINCPAC. The USFACOM Service component commands consist of the respective component commanders and all those individuals, units, detachments, organizations, and installations under their command which have been assigned to USCINCPAC's combatant command. Other individuals, units, detachments, organizations, or installations may operate directly under the USFACOM Service component commander in his Service role. However, such missions and tasks must not detract from and should contribute to the overall mission of USCINCPAC.

1. (U) The USFACOM Service component commanders' responsibilities for the Security Assistance Program are prescribed in the current version of DOD 5105.38 (Security Assistance Management Manual) and USCINCPAC Instruction 4900.8.

3. (U) COMMANDERS OF SUBORDINATE UNIFIED COMMANDS:

- a. (U) Commander, U.S. Forces, Korea (COMUSKOREA)*, Seoul, Korea, commanding U.S. Forces Korea (USFK).
- b. (U) Commander, U.S. Forces, Japan (COMUSJAPAN)*, Yokota Air Base, Japan, commanding U.S. Forces Japan (USFJ).
- c. (U) Commander, Alaskan Command (COMALCOM), Elmendorf Air Force Base, Alaska, commanding Alaskan Command (ALCOM).
- d. (U) Commander, Special Operations Command, Pacific (COMSOPAC), Camp H.M. Smith, Hawaii, commanding Special Operations Command, Pacific (SOCPAC).

4. (U) JOINT TASK FORCE COMMANDERS (ACTIVE):

- a. Commander, Joint Interagency Task Force-West (CJIATF-W), Coast Guard Island, Alameda, California, commanding Joint Interagency Task Force-West (JIATF-W).
- b. Commander, Joint Task Force - Full Accounting (CJTF-FA), Camp H.M. Smith, Hawaii, commanding Joint Task Force - Full Accounting (JTF-FA).

5. (U) SUBORDINATE USCINCPAC DIRECT REPORTING ORGANIZATION CHIEFS/COMMANDERS:

- a. (U) Commander, Joint Intelligence Center Pacific (CDRJCPAC), Pearl Harbor, Hawaii.
 - b. (U) Chief, Cruise Missile Support Activity (CHCMSA), Camp H.M. Smith, Hawaii.
 - c. (U) Commander, Information Systems Support Group (CDRISSG), Camp H.M. Smith, Hawaii.
6. (U) REPRESENTATIVES OF THE COMMANDER IN CHIEF, U.S. PACIFIC COMMAND (USCINCPACREPs): Generally, USCINCPACREPs are designated in certain areas where no subordinate unified command has been established.
- a. (U) USCINCPACREP Australia is the Defense Attaché, American Embassy, Canberra, Australia.
 - b. (U) USCINCPACREP Cambodia is the Security Assistance Officer for USCINCPAC.
 - c. (U) USCINCPACREP Fiji (includes French Polynesia, Kiribati, Nauru, New Caledonia, Tonga, Tuvalu, Wallis and Futuna) is the Defense Attaché, American Embassy, Suva, Fiji.
 - d. (U) USCINCPACREP Guam/Commonwealth of the Northern Mariana Islands/Federated States of Micronesia/Palau (USCINCPACREP Guam/CNMI/FSM/Palau) is the Commander, U.S. Naval Forces Marianas (COMNAVMIANAS), Agaña, Guam.
 - e. (U) USCINCPACREP Republic of the Marshall Islands (USCINCPACREP RMI) is the Commander, U.S. Army Kwajalein Atoll, Marshall Islands.

1. (U) USCINCPACREP New Zealand (includes Cook Islands, Niue, Tokelau, and Western Samoa) is the Defense Attaché, American Embassy, Wellington, New Zealand.

g. (U) USCINCPACREP Philippines (USCINCPACREP PHIL) is the Chief, Joint United States Military Advisory Group Philippines (CHJUSMAGPHIL), Manila, Philippines.

h. (U) USCINCPACREP Singapore is the commander, 497th Fighter Training Squadron, 13th Air Force, Singapore.

1. (U) USCINCPACREP Sri Lanka/Maldives is the Defense Attaché, Colombo, Sri Lanka.

j. (U) USCINCPACREP Thailand (USCINCPACREP THAI) is the Chief, Joint United States Military Advisory Group, Thailand (CHJUSMAGTHAI), Bangkok, Thailand.

7. (U) USCINCPAC LIAISON ACTIVITIES: USCINCPAC Liaison Office, Washington, D.C.

8. (U) SECURITY ASSISTANCE ORGANIZATIONS AND COMMANDERS: Command relationships and terms of reference are identified in USCINCPAC Instruction 3020.2K.

CONFIDENTIAL

416

CONFIDENTIAL

Classified by: US Pacific Command Digest(S/NF). Source marked OADR, dtd 15 Feb 1995.

U.S. SECURITY ASSISTANCE ORGANIZATIONS

DEFENSE SUPPLY ADVISOR, INDIA				JOINT U.S. MILITARY ADVISORY GROUP, THAILAND			
DSA	Col	Walter T. EASTHAM	USAF	Chief	COL	Thomas A. SWINDELL	USA
Assistant DSA	MAJ	T. James REZEKI	USA	Chief Joint Exercise Branch	Col	Eric P. VISSER	USMC
OFFICE OF THE MILITARY ATTACHE FOR DEFENSE PROGRAMS, INDONESIA				Chief Army SA Div	COL	Richard P. CASSIDY	USA
Chief	COL	Karl F. EICKEMEYER	USA	Chief Joint Navy Div	CAPT	Gregory R. OSTROWSKI	USN
Chief Army/MAP Div	LTC	Lloyd T. GREEN	USA	Chief Joint Air Force Div	Col	Anthony J. SOBOL	USAF
Chief Navy/Plans Div	CDR	David A. HAMEL	USN	Marine Corps Rep	LtCol	Robert STRAHAN	USMC
Chief Air Force Div	Lt Col	John C. STEVENS	USAF	Chief Joint Training Div	MAJ	Dale FAULK	USA
Chief, Training and Admin Support Div	MAJ	Michael D. HAUSER	USA	*****			
MUTUAL DEFENSE ASSISTANCE OFFICE, JAPAN				OTHER OFFICIALS RESPONSIBLE FOR SECURITY ASSISTANCE			
Chief	COL	Thomas L. BROWN	USA	AUSTRALIA (Defense Attache)	Col	Stephen E. BARNEYBACK	USAF
Deputy Chief	Mr.	Rodney S. TANAKA	CIV	Office of Defense Cooperation	Col	Mike E. SCOTT	USAF
Director Air Defense/Ground Forces Div	LTC	Patrick W. OYABE	USA	BANGLADESH (Defense Attache)	LTC	James A. DUNN, Jr.	USA
Director Naval Aviation Programs	CDR	William A. SCHLEITER	USN	BRUNEI (Army Attache Singapore)	COL	Richard D. WELKER	USA
Naval Sea Systems Programs Officer	CDR	Dean K. VAUGHN	USN	BURMA (Defense Attache)	COL	Dan W. LEE	USA
Director Air Force Programs	Maj	Stephen WATKINS	USAF	CHINA (Defense Attache)	SG	Michael T. BYRNES	USA
Director Defense Technology Office	Mr.	Noboru FLORES	CIV	COMOROS (Defense Attache Madagascar)	LCDR	John W. LOGAN	USN
JOINT U.S. MILITARY AFFAIRS GROUP, KOREA				FJI (Defense Attache)	LtCol	Kip J. NAUGLE	USMC
Chief	COL	Keith L. YOUNG	USA	MALAYSIA (Defense Attache)	COL	Michael A. McDERMOTT	USA
Director Technology, Training and Operations	COL	Sammy J. COWDEN	USA	Chief Security Assistance Office	LTC	Russel P. THURBER II	USA
Director Army Programs	COL	George INGERSOLL	USA	MALDIVES (Defense Attache Sri Lanka)	LTC	Carl COCKRUM	USA
Director Air Force Programs	Col	L. K. CORMNEY	USAF	MONGOLIA (Air Attache China)	Col	Donald RONALD	USAF
Director Navy/Marine Corps Programs	CAPT	R. Y. FELT	USN	NEPAL (SAC)	Mr.	Prem BINGH	FSN
Director Support	Lt Col	David E. EDWARDS	USAF	NEW ZEALAND (Defense Attache)	CAPT	Richard L. NORWOOD	USN
JOINT U.S. MILITARY ASSISTANCE GROUP, PHILIPPINES				SINGAPORE (Defense Attache)	CAPT	Jeremy C. ROSENBERG	USN
Chief	COL	Wayne M. BARTH	USA	Chief Security Assistance Office	Lt Col	Dennis B. FOWLER	USAF
USCINCPACREP	COL	Wayne M. BARTH	USA	SOLOMON ISLANDS (Army Defense Attache Australia)	COL	Shelby STEVENS	USA
Chief Security Assistance Div	Col	Richard D. WHITE	USAF	SRI LANKA (Defense Attache)	LTC	Carl COCKRUM	USA
Chief Army Branch	LTC	Albert O. COSIO	USA	TONGA (Defense Attache FJI)	LtCol	Kip J. NAUGLE	USMC
Chief Naval Forces Branch	Vacant			VANUATU (Army Defense Attache Australia)	COL	Shelby STEVENS	USA
Comptroller	MAJ	Sherwin MAYNOR	USA	TAIWAN (Chief, Tech Affairs Sect)	Mr.	Gus SORENSON	CIV

Classified by: US Pacific Command Digest(S/NF). Source marked OADR, dtd 15 Feb 1995.

UNCLASSIFIED
418

UNCLASSIFIED

AVAILABLE FORCES (U)

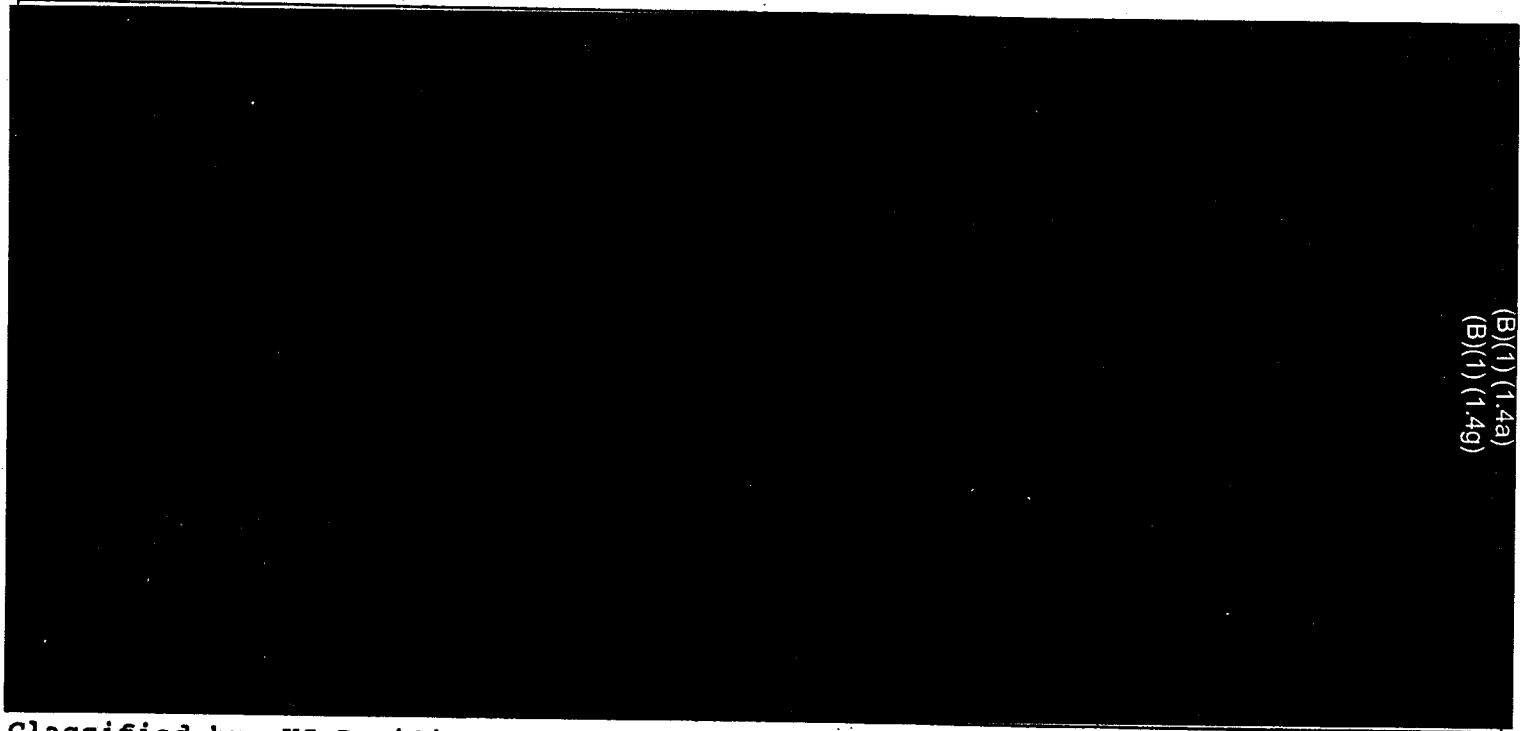

(B)(1) (1.4a)
(B)(1) (1.4g)

SECRET

SECRET
419

Classified by: US Pacific Command Digest(S/NF). Source marked OADR, dtd 15 Feb 1995.



1.5(a)(g)

1-5 (6) (6)

AVAILABLE FORCES (U)
(continued)



(B)(1) (1.4a)
(B)(1) (1.4g)

SECRET

SECRET
420

Classified by: US Pacific Command Digest(S/NF). Source marked OADR, dtd 15 Feb 1995.

└



MAJOR USPACOM BASES AND COMPLEXES

ARMY	NAVY	AIR FORCE	MARINE CORPS*	COAST GUARD*
Schofield Barracks, Hawaii Fort Shafter, Hawaii Fort Richardson, Alaska Fort Wainwright, Alaska Camp Zama, Japan Sagami Depot, Japan Torii Station, Okinawa, Japan Camp Henry, Taegu, Korea Camp Hovey, Tongduchon-ni, Korea Camp Howze, Kumchon, Korea Camp Humphreys, Pyong-taek, Korea Camp Red Cloud, Uijong-bu, Korea Camp Casey, Tongduchon-ni, Korea Camp Carroll, Waegwan, Korea U.S. Army Garrison, Yongson, Seoul, Korea Camp Walker, Taegu, Korea	Naval Complex Pearl Harbor, Hawaii Naval Air Station Barbers Point, Hawaii Naval Air Station Adak, Aleutian Islands, Alaska Naval Complex Apra Harbor, Guam Naval Air Station Agaña, Guam Naval Complex Yokosuka, Japan Naval Complex Sasebo, Japan Naval Fleet Activities Okinawa/Naval Air Facility Kadena, Japan Naval Air Facility Atsugi, Japan Naval Air Facility Misawa, Japan Naval Complex Chinhae, Korea Naval Complex Diego Garcia, British Indian Ocean Territory	Hickam Air Force Base, Hawaii Elmendorf Air Force Base, Alaska Eielson Air Force Base, Alaska Eareckson Air Force Base, Alaska Andersen Air Force Base, Guam Yokota Air Base, Japan Misawa Air Base, Japan Kadena Air Base, Okinawa, Japan Osan Air Base, Korea Kunsan Air Base, Korea	Camp Fuji, Japan Marine Corps Base, Hawaii Marine Corps Base Camp Butler, Okinawa, Japan Marine Corps Air Station Iwakuni, Japan Marine Corps Air Station Futenma, Japan * Excludes U.S. West Coast bases.	Air Station/Support Center/Base, Kodiak, Alaska Air Station, Barbers Point, Hawaii Group/Base, Honolulu, Hawaii Marianas Section, Guam * Excludes U.S. West Coast bases.

Classified by: US Pacific Command Digest(S/NF). Source marked OADR, dtd 15 Feb 1995.

UNCLASSIFIED
421

UNCLASSIFIED

U.S. ARMY PACIFIC

PRINCIPAL MISSIONS AND TASKS

- Functions as Army component for USPACOM, less geographical area of Korea, and for matters of USCINCPAC concern beyond exclusive authority or transcending geographic areas of Commanding General, Eighth U.S. Army (CG EUSA).
- Commands and supports assigned and attached active and U.S. Army Reserve units, installations, and activities in Japan, Hawaii, Alaska, and in possessions and trust territories administered by the United States in the USPACOM.
- Organizes, equips, stations, and maintains the combat readiness of assigned units.
- Develops plans for ground offensive and defensive operations for USPACOM less those exclusively for Korea, Japan, or Alaska.
- Performs theater-wide functions for the Army in USPACOM less Korea as directed by Department of the Army.
- Exercises resource management functions and responsibilities of a Major Army Command (MACOM).
- Supervises the training and readiness of the Hawaii, Alaska, and Guam Army National Guard.
- Is USCINCPAC Executive Agent in the operations of the Pacific Topographic Center.
- Arranges and coordinates U.S. Army Security Assistance support to meet USCINCPAC requirements except in Korea.
- Exercises command responsibility for the U.S. Army Chemical Activity Pacific (USACAP) for the custody and security of the toxic chemical munitions and agents stored on Johnston Island, and provides safety oversight of the operations of the Johnston Atoll Chemical Agent Disposal System (JACADS).



DIRECTORY OF KEY STAFF PERSONNEL

Commanding General	LTG	Robert L. ORD, III
Deputy Commander/Chief of Staff	MG	David R. E. HALE
Deputy Commander for Reserve Components	BG	Calvin LAU
Secretary General Staff	LTC	Kim T. CHAPMAN
DCoFS for Personnel	COL	Archibald V. ARNOLD, III
DCoFS for Intelligence	COL	Mark S. PERNELL
DCoFS for Operations and Plans	COL	Thomas D. SCOTT
DCoFS for Logistics	COL	David M. EMLING
DCoFS for Resource Management	COL	Curtis HOLLAND
DCoFS for Engineering	COL	Jesse C. GATLIN, III
DCoFS for Information Management	COL	John B. McDOUGLE
DCoFS for Acquisition Management	Mr.	Richard O. YOUNG
Chief Surgeon*	BG	James HASTINGS
Chief Dental Surgeon	COL	Jeryl D. ENGLISH
Public Affairs Officer	COL	H. T. LINKE
Inspector General	COL	Terry J. YOUNG
Staff Judge Advocate	COL	Terry E. THOMASON
Chaplain	COL (Ch)	John A. FLASKA, Jr.
Provost Marshal	COL	James L. SAUNDERS
Protocol Officer	MAJ	Deborah L. NYKFORCHYN

Commanding General, 25th Infantry Division (Light)	MG	George A. FISHER
Commanding General, U.S. Army Alaska	MG	Thomas H. NEEDHAM
Commander, Tripler Army Medical Center*	BG	James E. HASTINGS
* U.S. Army Health Services Command		

UNCLASSIFIED

422

UNCLASSIFIED

Classified by: US Pacific Command Digest(S/NF). Source marked OADR, dtd 15 Feb 1995.

**U.S. ARMY
PACIFIC ORGANIZATION**

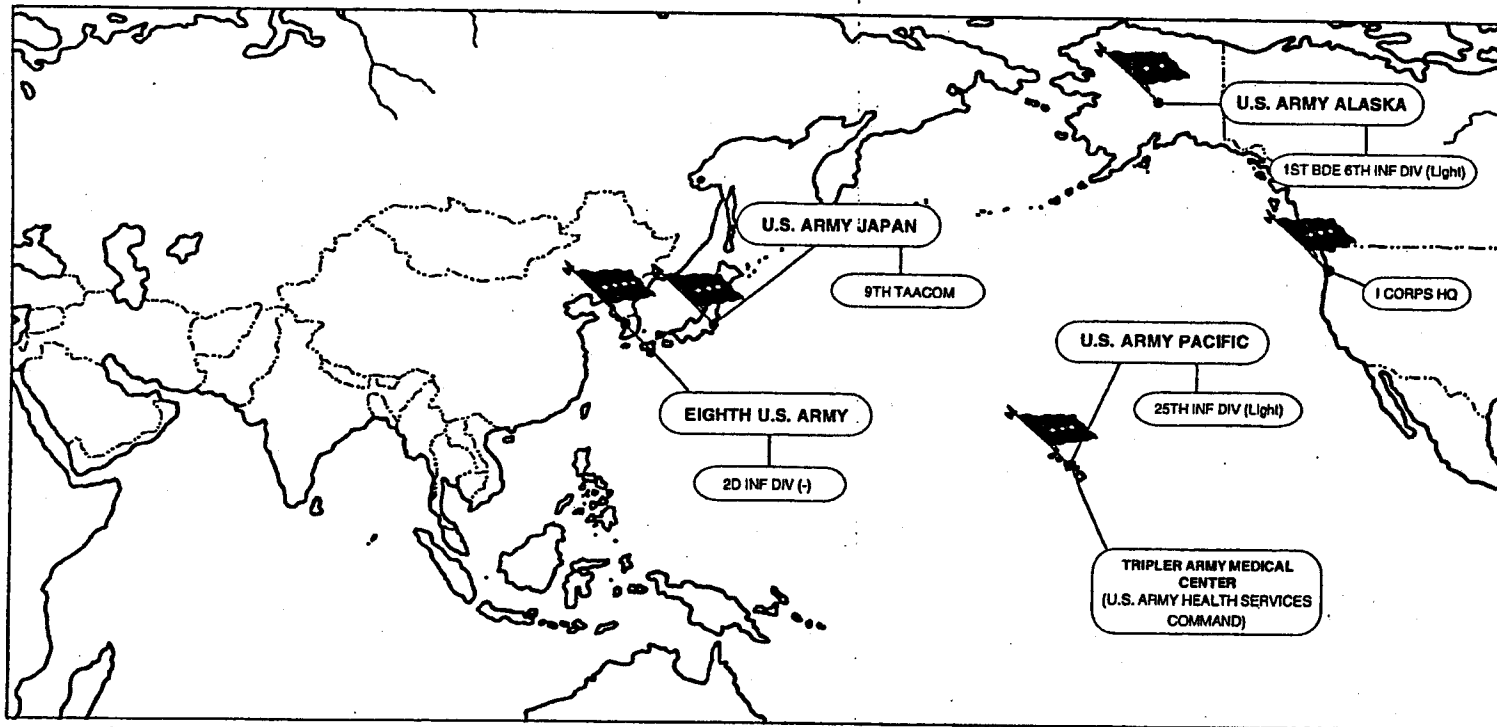

Classified by: US Pacific Command Digest(S/NF). Source marked OADR, dtd 15 Feb 1995.

UNCLASSIFIED
423

UNCLASSIFIED

1609
Whole page

DEPLOYMENT OF MAJOR ARMY UNITS (U)

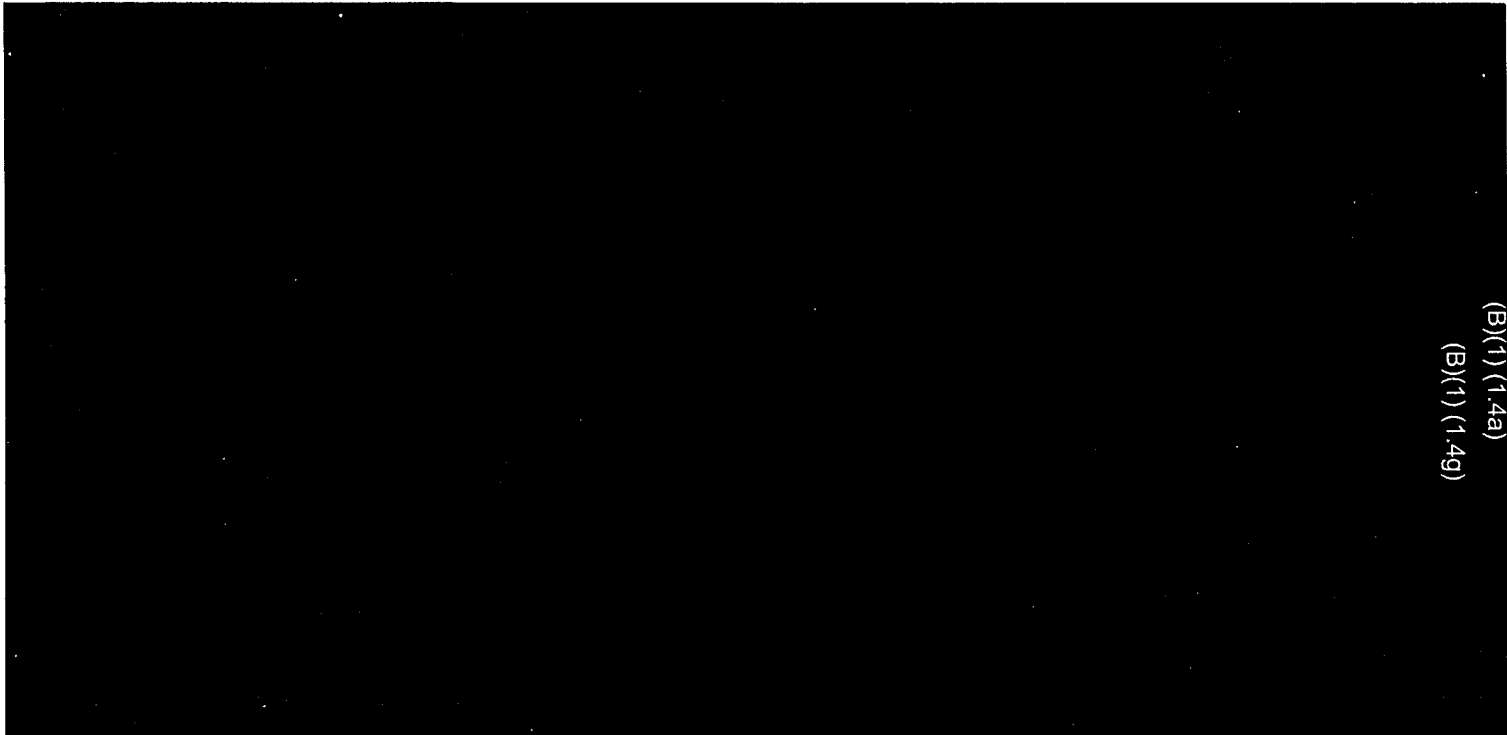

(B)(1) (1.4a)
(B)(1) (1.4g)

~~SECRET~~

SECRET
424

Classified by: US Pacific Command Digest(S/NF). Source marked OADR, dtd 15 Feb 1995.

U.S. PACIFIC FLEET

PRINCIPAL MISSIONS AND TASKS

Prepare to:

- Assist in defense of the United States against attack through the Pacific.
- Deny enemy control of island areas.
- Assist in the defense of friendly nations.
- Protect and control shipping and maintain sea lines of communications in the USPACOM and contiguous waters; integrate plans for antisubmarine warfare and mining operations.
- Coordinate the shipping surveillance program; operate shipping surveillance center.
- Provide defense of naval forces at sea against air attack.
- Assist in air defense of land areas.
- Provide for conduct of planning with friendly nations, as directed.
- Determine requirements for a strategic logistic sealift capability to support USCINCPAC plans.

ORGANIZATION

The United States Pacific Fleet is organized into a number of Type and Area Commands for purposes of administration, training, and logistic support and into Operational Commands for the pursuit of its assigned missions, as follows...

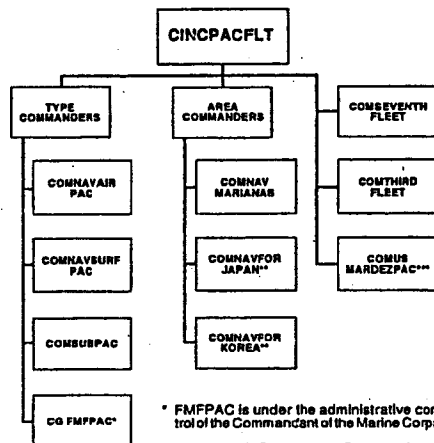

DIRECTORY OF KEY STAFF PERSONNEL

HEADQUARTERS U.S. PACIFIC FLEET

Commander in Chief	ADM	Ronald J. ZLATOPER
Dep CINC/Chief of Staff	RADM	James R. FITZGERALD
Dep CoS Operations/Plans	RADM	Richard A. WILSON
Dep CoS Resources/Logistics	RADM(S)	Edward GIAMBASTIANI
ACoS Intelligence	CAPT	Nelson H. LITSINGER
ACoS Operations	CAPT	Robert B. DANBERG
ACoS Logistics Planning	CDR	Alan R. HAGER
ACoS Communications	CAPT	William S. BERTHIAUME
ACoS Plans and Policy	CAPT	David W. PRATHER
ACoS Cryptology	CAPT	John P. O'NEILL
ACoS Manpower and Personnel	CAPT	William W. SPOTTS
ACoS Shore Activities	RADM	Ronald D. TUCKER
Fleet Comptroller Officer	CAPT	Edward C. McDONOUGH
Fleet Public Affairs Officer	CAPT	Stephen H. CLAWSON
Fleet Inspector General	MR	Ronald Q. TAM
Fleet Surgeon	CAPT	Kenneth L. ANDRUS
COMPACNAVFACENGCOM		
Fleet Civil Engineer	RADM	David J. NASH
ACoS Fleet Supply Officer	RADM	Peter A. BONDI
ACoS Fleet Maintenance	RADM	Michael T. COYLE
Fleet Dental Officer	CAPT	Jim P. BACK
Fleet Chaplain	CAPT	Edwin A. CONDON
Fleet Judge Advocate	CAPT	Albert A. REYNOLDS

Commander THIRD Fleet	VADM	Conrad C. LAUTENBACHER, Jr.
Commander SEVENTH Fleet	VADM	Archie R. CLEMINS
Commander U.S. Maritime Defense Zone Pacific (USN-USCG)	VADM	Richard D. HERR

Classified by: US Pacific Command Digest(S/NF). Source marked OADR, dtd 15 Feb 1995.

UNCLASSIFIED
425

UNCLASSIFIED

U.S. PACIFIC FLEET COMMAND ORGANIZATION

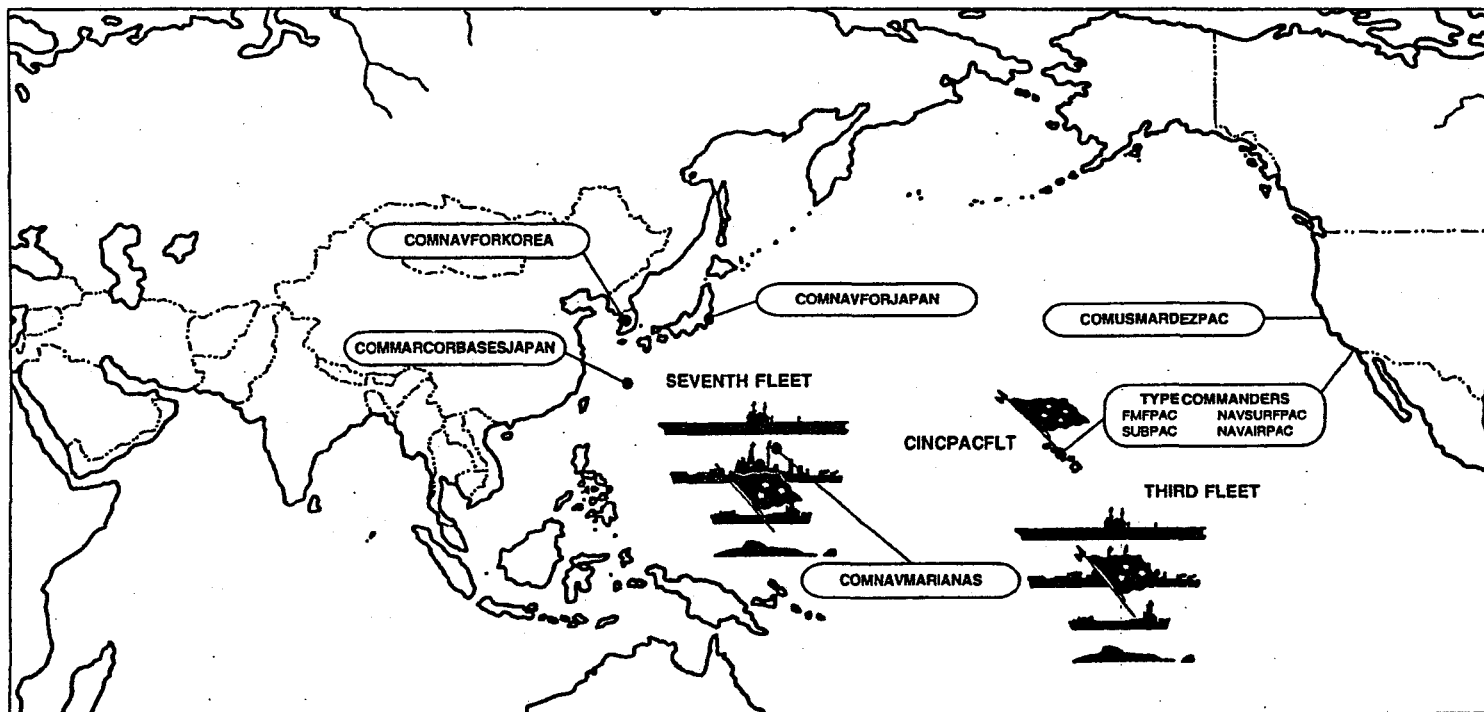

Classified by: US Pacific Command Digest(S/NF). Source marked OADR, dtd 15 Feb 1995.

UNCLASSIFIED
426

UNCLASSIFIED

DEPLOYMENT OF MAJOR NAVY AIR AND SHIP UNITS (U)



(B)(1) (1.4a)
(B)(1) (1.4g)

~~SECRET~~
427

SECRET

Classified by: US Pacific Command Digest(S/NF). Source marked OADR, dtd 15 Feb 1995.

*Whole lot
1.5 (a)(A)*

MARINE FORCES PACIFIC

PRINCIPAL MISSIONS AND TASKS

- Provides the Marine Component Headquarters for the Commander in Chief, Pacific.
- COMMARFORPAC will serve as the U.S. Marine Component Commander (Designate) (COMMARFORK) for the Commander, U.S. Forces Korea.
- In addition, COMMARFORK will also serve as the Commander, Combined Marine Forces Command (COMCMFC) for Commander in Chief, United Nations Command/Combine Forces Command (CINCUNC/CFC) in Korea.
- Responsible for providing and sustaining forces, and advising the CINC(s) on the proper employment and deployment of those forces.
- COMMARFORPAC will serve as the U.S. Marine Component Commander (Designate) (COMMARCEN) for the Commander, U.S. Central Command.
- Commander, Marine Forces Pacific will also function as CG, FMFPac, a fleet type commander under the operational control (OPCON) of the Commander in Chief, U.S. Pacific Fleet (CINCPACFLT).
- Advises the supported CINCs on the deployment and employment of Marine Forces.
- Provides sustainment for all Marine forces assigned.
- Develop supporting operational and exercise plans and necessary force data.
- Commander, Marine Forces Pacific as the Commander, Marine Corps Base, Pacific, provides essential facilities and services necessary to preserve operational readiness and promote well-being to tenant units, individual Marines, other Department of Defense personnel and their families.

COMMANDER MARINE FORCES PACIFIC COMMAND RELATIONSHIPS

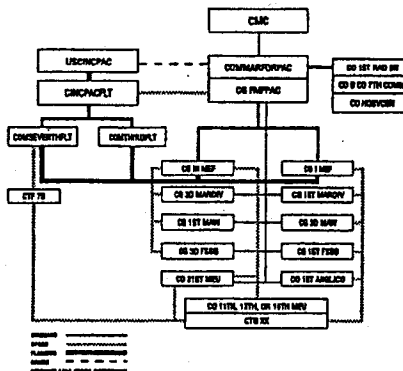

DIRECTORY OF KEY STAFF PERSONNEL

MARINE FORCES PACIFIC/FLEET MARINE FORCE PACIFIC

Commander/Commanding General/ COMMARCORBASESPAC	LGen	Charles C. KRULAK
Dep Commander/Dep CG/ COMMARCORBASESPAC	MGen	Jefferson D. HOWELL, Jr.
Chief of Staff	Col	Garry L. PARKS
ACofS, G-1	Col	Michele MANNING
ACofS, G-2	Col	Keith L. MAXFIELD
ACofS, G-3	Col	John S. SNOWDEN
ACofS, G-4	Col	Gary H. HUGHEY
ACofS, G-5	Col	William M. GIVEN, III
ACofS, G-6	Col	Paul F. ROQUES, Jr.
ACofS, G-7	Col	Randolph A. GANGLE
ACofS, Comptroller	Col	Gale E. HEAVILIN
ACofS, Aviation Logistics	Col	Patrick E. GARRETT
Force Engineer Officer	LiCol	Paul R. FIELDS
Staff Judge Advocate	Col	William J. LUCAS
Force Medical Officer	Capt	Robert S. CARNES, USN
Force Dental Officer	Capt	James T. JUDKINS, USN

.....

Commander General I Marine Expeditionary Force	LGen	Anthony C. ZINNI
Commanding General III Marine Expeditionary Force	MajGen	Carlton W. FULFORD, Jr.

UNCLASSIFIED

428

UNCLASSIFIED

Classified by: US Pacific Command Digest(S/NF). Source marked OADR, dtd 15 Feb 1995.

**MARINE FORCES PACIFIC
COMMAND ORGANIZATION**

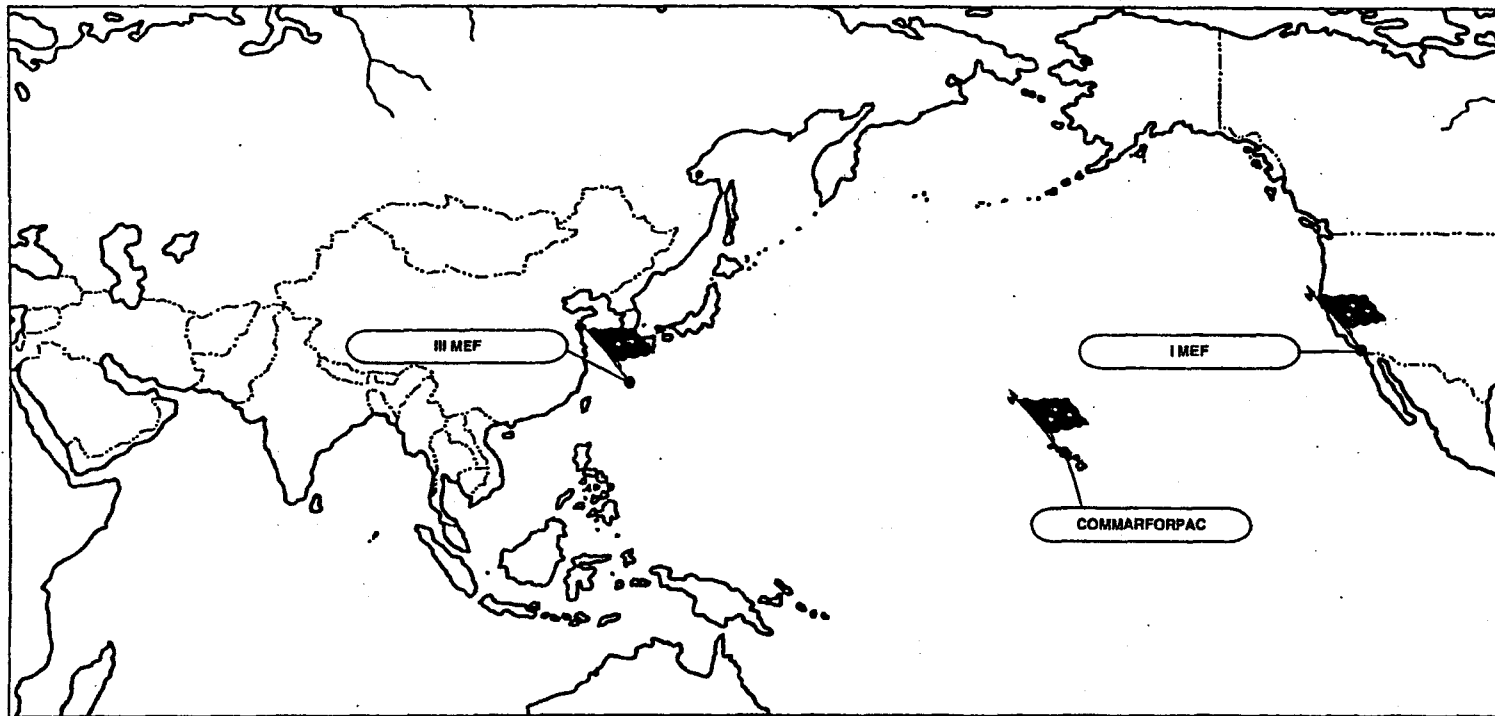

Classified by: US Pacific Command Digest(S/NF). Source marked OADR, dtd 15 Feb 1995.

UNCLASSIFIED
429

UNCLASSIFIED

*Whole Page
1.5
(B)(1)(C)*

DEPLOYMENT OF MAJOR MARINE CORPS UNITS (U)



(B)(1)(1.4a)
(B)(1)(1.4g)

SECRET

UNCLASSIFIED
430

Classified by: US Pacific Command Digest(S/NF). Source marked OADR, dtd 15 Feb 1995.

PACIFIC AIR FORCES

PRINCIPAL MISSIONS AND TASKS

Prepare to:

- Conduct offensive and defensive air operations in accordance with USCINCPAC Operation Plans.
- Assist in the defense of the United States against attack through the Pacific.
- Assist in the defense of friendly nations in the Pacific.
- Conduct aerial reconnaissance and reconnaissance technical support.
- Conduct air search and rescue operations in the USPACOM area.
- Provide air support, both offensive and defensive, for other component commanders and subordinate unified commanders.

Provide tactical airlift for USPACOM forces.

Support other USAF forces operations in the USPACOM area.

Exercise general directive authority over other USAF forces operating in support of USCINCPAC.

Assist Air Force sections in all aspects of the Security Assistance Program for friendly air forces in the USPACOM.

Develop plans for USPACOM air offense and defense operations and act as the USCINCPAC principal adviser on employment of aerospace power.

Function as USPACOM coordinating authority for Survival, Evasion, Resistance, Escape, and Recovery (SERER) matters.

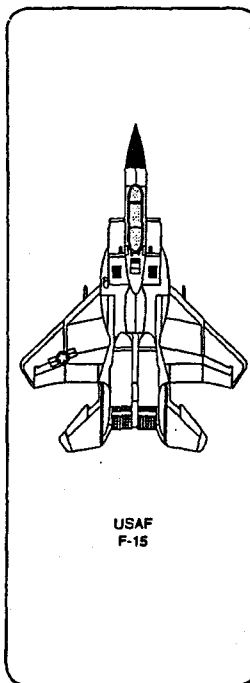

DIRECTORY OF KEY STAFF PERSONNEL

Commander Pacific Air Forces	Gen	John G. LORBER
Vice Commander	Lt Gen	John S. FAIRFIELD
Director of Staff	Lt Col	Eugene H. QUINTANILLA
Director for Personnel	Col	Steven L. TINDELL
Director for Operations	Maj Gen	Robert P. KELLY
Director for Intelligence	Col	Paul L. LEBRAS
Director for Plans	Maj Gen	John M. McBROOM
Director for Logistics	Col	Richard M. MAY, Jr.
Director for Financial Management		
Comptroller	Col	Charles W. MARTIN
Director for Civil Engineering	Col	Philip G. STOWELL
Director for Communications-		
Computer Systems	Col	Henry J. DARIES
Director for Security Police	Col	Lawrence R. MAYES
Director for Services	Col	Charles B. LONG
Director for Quality Improvement	Col	Michael E. SOLOMON
Command Surgeon	Col	John G. JERNIGAN
Staff Judge Advocate	Col	Gilbert T. REGAN
Command Chaplain	Col (CH)	Karl W. BARMANN
Director of Public Affairs	Col	Ronald T. RAND
Director of Information Management	Col	Brian D. MILLER
Director of Safety	Col	Roger C. LOCHER
Inspector General	Col	Steph E. TRENT
Command Historian	Dr.	Timothy R. KECK
.....		
Commander Fifth Air Force	Lt Gen	Richard B. MYERS
Commander Seventh Air Force	Lt Gen	Ronald W. IVERSON
Commander Eleventh Air Force	Lt Gen	Lawrence E. BOESE
Commander Thirteenth Air Force	Maj Gen	Richard T. SWOPE

UNCLASSIFIED
431

UNCLASSIFIED

Classified by: US Pacific Command Digest(S/NF). Source marked OADR, dtd 15 Feb 1995.

PACIFIC AIR FORCES COMMAND ORGANIZATION

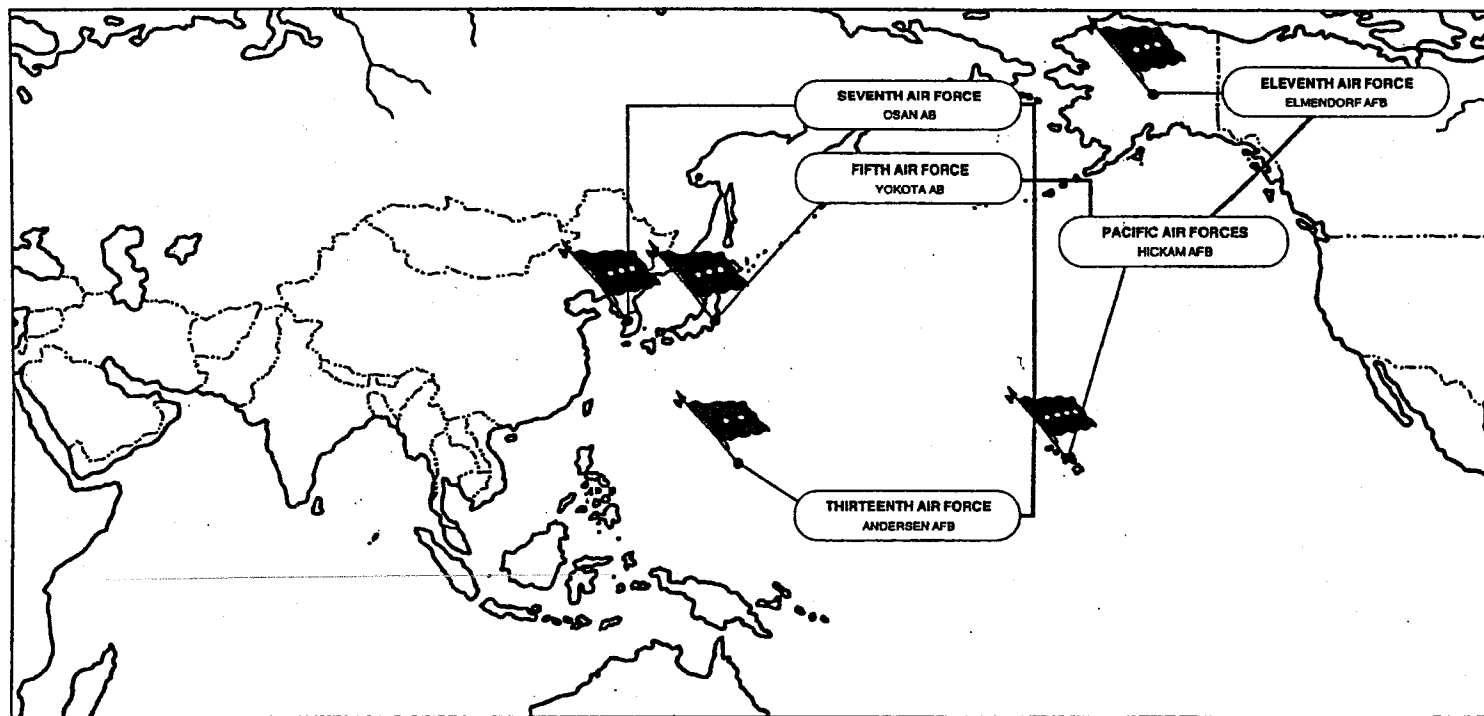

UNCLASSIFIED
432

UNCLASSIFIED

Classified by: US Pacific Command Digest(S/NF). Source marked OADR, dtd 15 Feb 1995.

DEPLOYMENT OF MAJOR AIR FORCE UNITS (U)

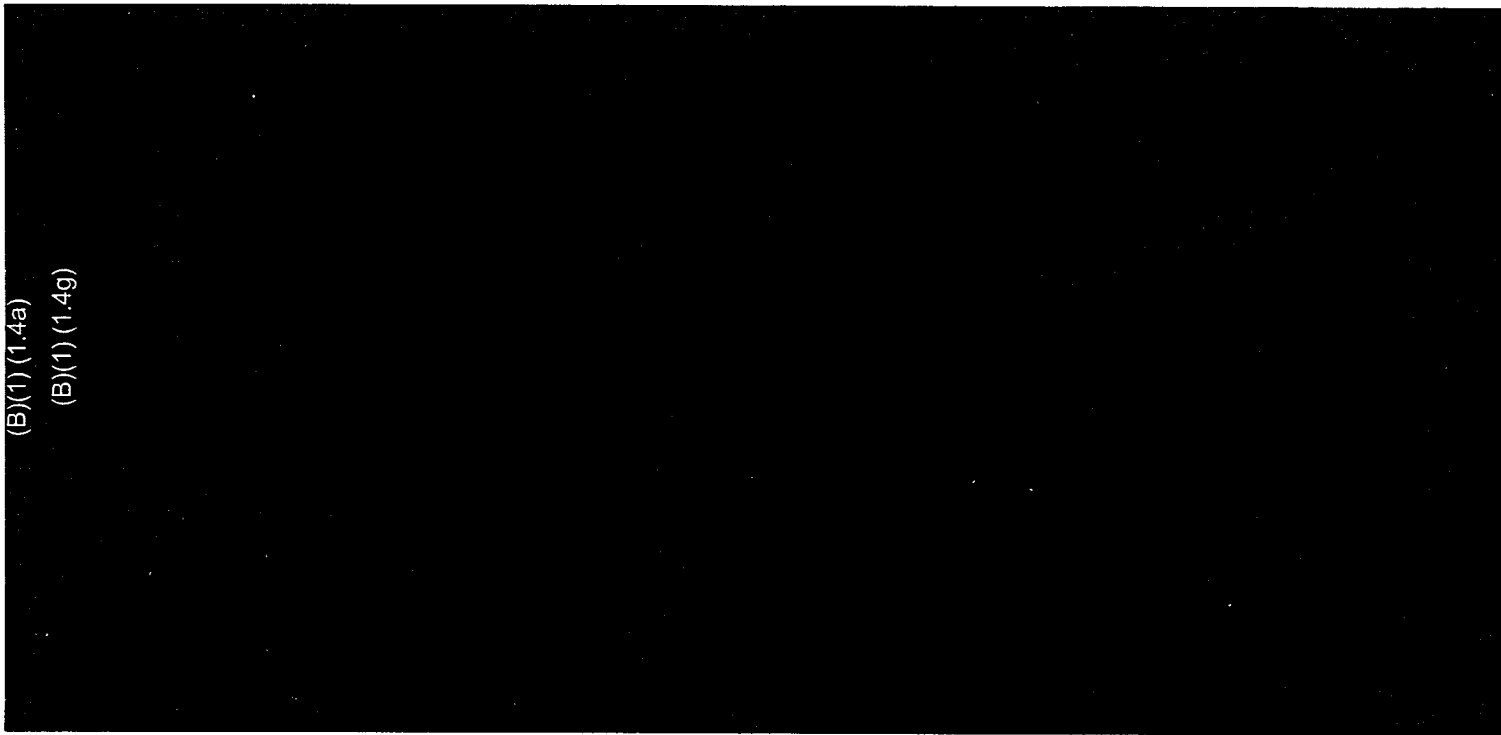

(B)(1) (1.4a)
(B)(1) (1.4g)

UNCLASSIFIED
433

~~SECRET~~

Classified by: US Pacific Command Digest(S/NF). Source marked OADR, dtd 15 Feb 1995.

*Whole page
1.5 (0769)*

U.S. COAST GUARD PACIFIC AREA

PRINCIPAL MISSIONS AND TASKS

- The Coast Guard is one of the nation's five Armed Forces and has four primary roles:
 - Maritime Safety
 - Maritime Law Enforcement
 - Marine Environmental Protection
 - National Defense
- Coast Guard forces are constituted to be fully interoperable with the Navy and other DoD forces. With the reduction in the number of Navy ships in the PACOM AOR, the existence of a highly-trained Coast Guard, in a high state of readiness, offers the CINC the potential for a significant augment to the Base Force naval structure in times of crisis response.
- Drawing on its peacetime roles, the Coast Guard provides USCINCPAC unique capabilities for national defense that do not duplicate those of the other armed services. The peacetime missions of the Coast Guard -- maritime law enforcement, marine safety, environmental protection, and search and rescue -- coupled with the maritime focus of the many island countries within the PACOM AOR, make the Coast Guard a valuable player in PACOM's cooperative engagement strategy.
- By statute, the Coast guard becomes a specialized service in the Navy when directed by the President or upon formal declaration of war by the Congress. The Coast Guard may also assist the navy without transferring forces by placing units under the operational control of a naval commander when requested by the Secretary of Defense.

ORGANIZATION

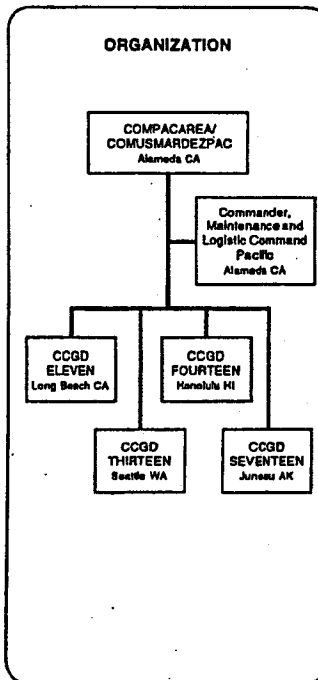

DIRECTORY OF KEY STAFF PERSONNEL

COMMANDER, U.S. COAST GUARD PACIFIC AREA/ COMMANDER, U.S. MARITIME DEFENSE ZONE PACIFIC

Commander	VADM	Richard D. HERR
Chief of Staff	CAPT	John L. Parker
Chief, Intelligence	CAPT	R. Lee CARPENTER
Chief, Operations	CAPT	Norman C. EDWARDS, Jr.
Chief, Plans	CAPT	Ray L. YEATS
Chief, CS	CAPT	Richard E. BURKE, Jr.
Legal Advisor	CAPT	William H. NORRIS

.....

Commander, Maintenance and Logistics Command Pacific	RADM	Gordon G. G. PICHE
--	------	--------------------

.....

Commander, Eleventh Coast Guard District/Commander, U.S. Maritime Defense Command 11	RADM	Richard A. APPLEBAUM
Commander, Thirteenth Coast Guard District/Commander, U.S. Maritime Defense Command 13	RADM	John W. LOCKWOOD
Commander, Fourteenth Coast Guard District/Commander, U.S. Maritime Defense Command 14	RADM	Howard B. GEHRING
Commander, Seventeenth Coast Guard District/Commander, U.S. Maritime Defense Command 17	RADM	Roger T. RUFÉ

UNCLASSIFIED

434

UNCLASSIFIED

Classified by: US Pacific Command Digest(S/NF). Source marked OADR, dtd 15 Feb 1995.

**U.S. COAST GUARD PACIFIC AREA
COMMAND ORGANIZATION**

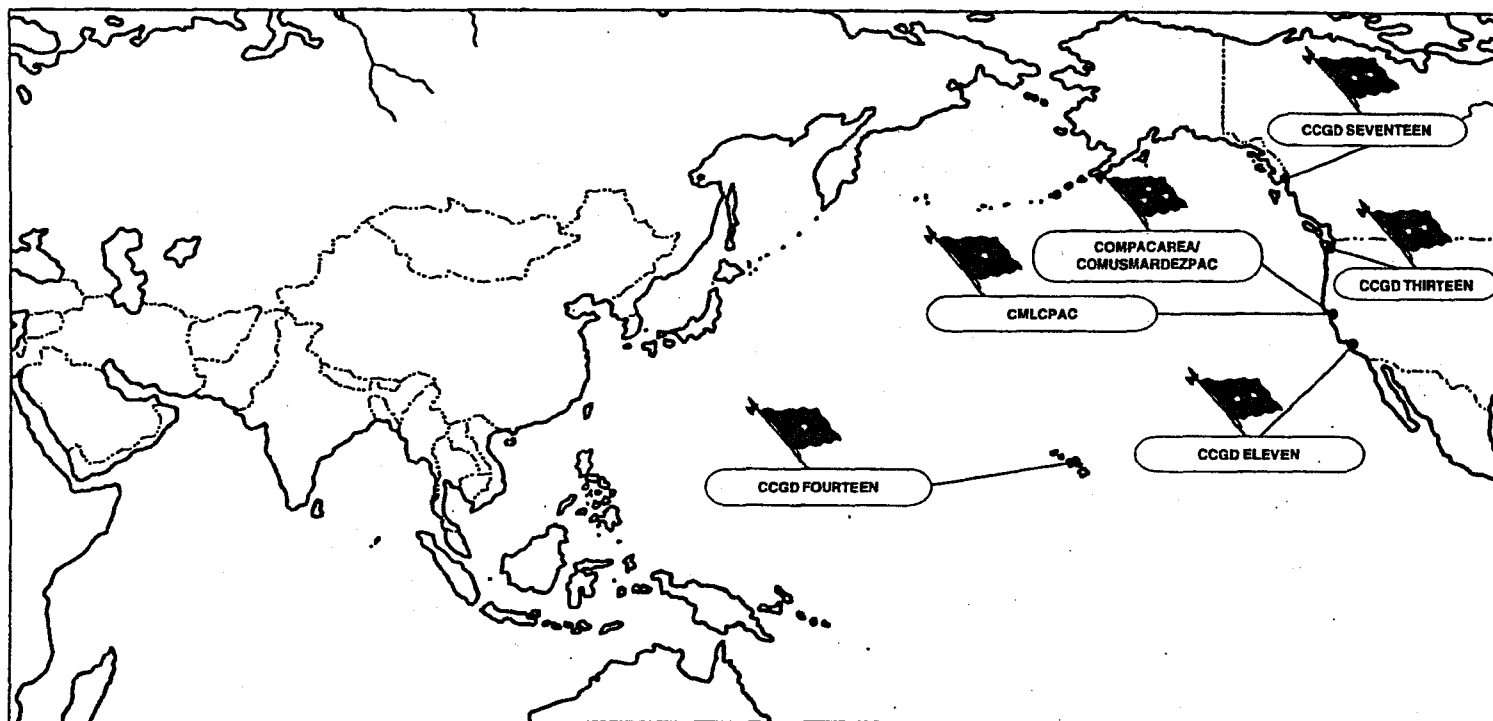

UNCLASSIFIED
435

UNCLASSIFIED

Classified by: US Pacific Command Digest(S/NF). Source marked OADR, dtd 15 Feb 1995.

*Whole Page
15 Feb 95*

DEPLOYMENT OF MAJOR COAST GUARD UNITS (U)

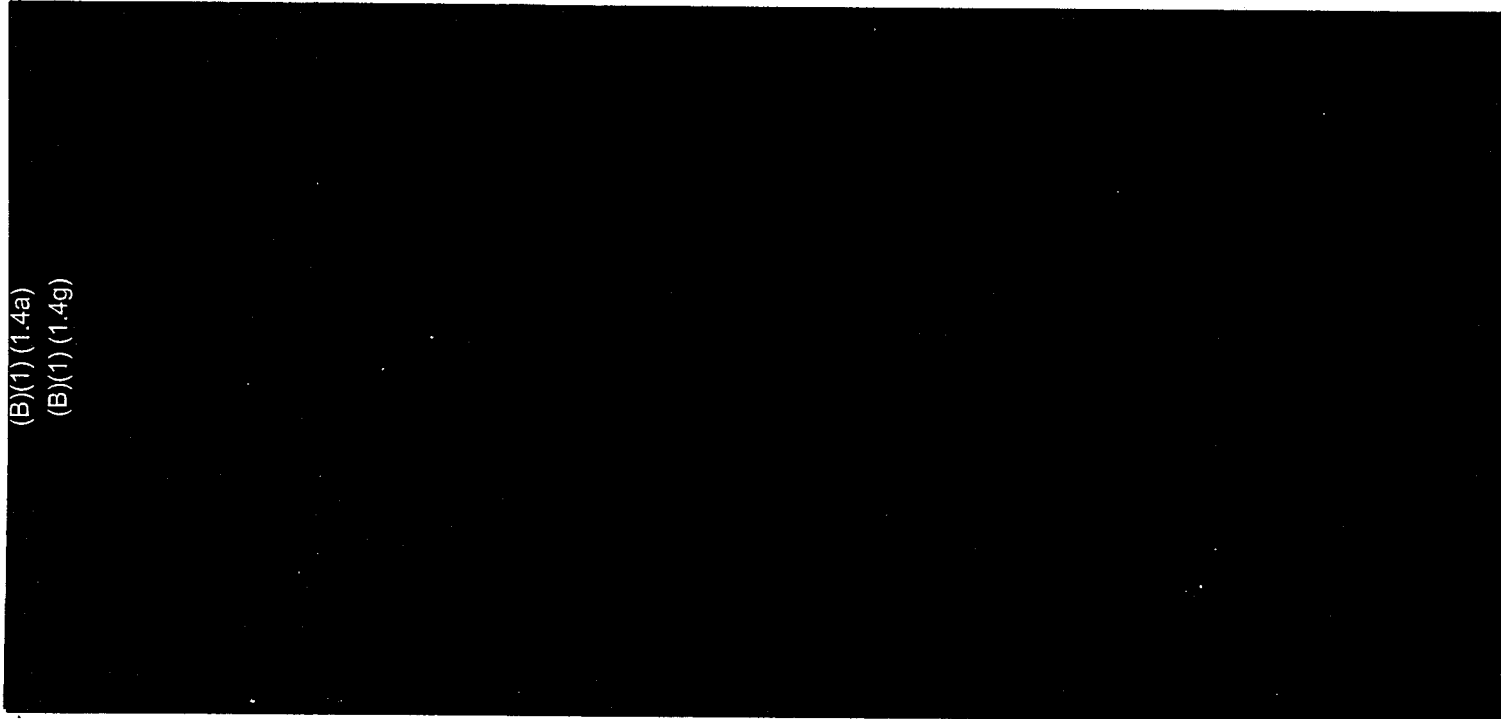

(B)(1) (1.4a)
(B)(1) (1.4g)

SECRET

SECRET
436

Classified by: US Pacific Command Digest(S/NF). Source marked OADR, dtd 15 Feb 1995.

U.S. SPECIAL OPERATIONS FORCES AND RESOURCES (U)



(B)(1) (1.4a)
(B)(1) (1.4g)

SECRET

SECRET
437

See Annex E to JSCP for Reserve Component Special Operations Forces with USPACOM area orientation and other forces capable of supporting special operations in the USPACOM.
* SEAL Platoons and Special Boat Unit Detachments under OPCON of Amphibious Squadron Commander.

Classified by: US Pacific Command Digest(S/NF). Source marked OADR, dtd 15 Feb 1995.

Whole Page
1.5 (a)(g)

USPACOM AREA DOD PERSONNEL
ASSIGNED AS OF 30 SEPTEMBER 1994

UNCLASSIFIED

438



(B)(2)High

UNCLASSIFIED

* Appropriated fund employees only.
** Excludes dependents of US civilians who are permanent residents and employed in the state or territory of their residence; i.e., Hawaii, Guam, etc.
*** Other - Fiji, Northern Mariana Islands, French Polynesia, Western Samoa & Brunei.

Sources of Data: (1) Component Commands (PACAF, USARPAC, PACFLT, and MARFORPAC) (As of 30 Sep 94) (includes stovepipes).

(2) DOD Worldwide Manpower Distribution by Geographical Area (MOS Report as of 30 Jun 94).

Note: NA = Not Available

Classified by: US Pacific Command Digest(S/NF). Source marked OADR, dtd 15 Feb 1995.

HQ USCINCPAC, COMPONENT, AND SUBORDINATE UNIFIED COMMAND
STAFF PERSONNEL

(AUTHORIZED AS OF 1 OCTOBER 1994)

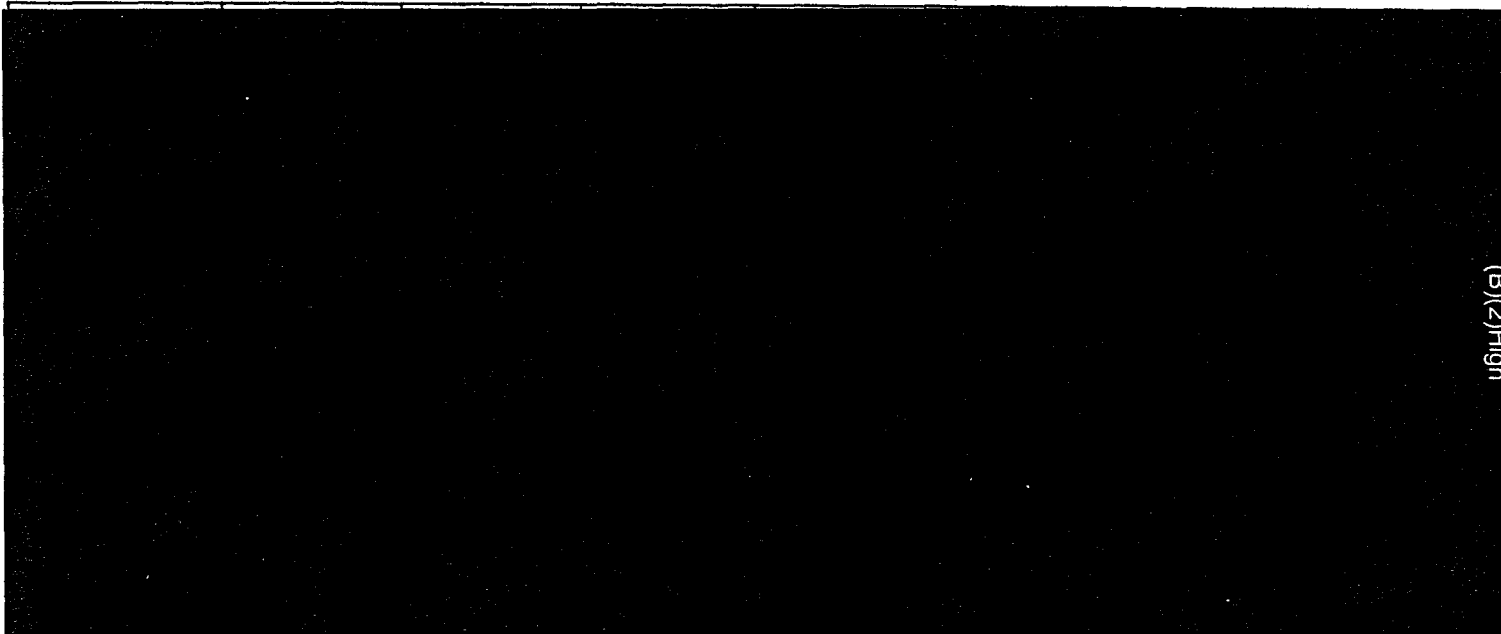

(B)(2)High

UNCLASSIFIED

UNCLASSIFIED

439

1. USCINCPAC - Cruise Missile Support Activity, Information Systems Support Activity, Joint Intelligence Center, Pacific, Joint Task Force - Full Accounting, and Pacific Stars and Stripes not included.
2. COMUSKOREA - Army figures do not include Headquarters Eighth U.S. Army.
3. Even though the organizations are not assigned to USCINCPAC, manpower documents for the United Nations Command/Combined Forces Command (HC UNC/CFC) are submitted through USCINCPAC headquarters J1 for JCS approval.

a. CINCPACFLT figures only include UIC 000070.

Classified by: US Pacific Command Digest(S/NF). Source marked OADR, dtd 15 Feb 1995.

**SECURITY ASSISTANCE ORGANIZATION PERSONNEL
AUTHORIZED STRENGTHS BY SERVICE & CIVILIAN CATEGORY FY95**

STAFF	ARMY		NAVY		USMC		USAF		TOTAL MILITARY		U.S. CIVILIANS	FOREIGN NATIONAL CIVILIANS
	OFF	ENL	OFF	ENL	OFF	ENL	OFF	ENL	OFF	ENL		
ODC AUSTRALIA			1	1			1		2	1	1	
DAO BANGLADESH												1
DAO NEPAL												1
DSA INDIA	1						1		2		1	3
OMADP INDONESIA	3	1	1	2			2	1	6	4	1	15
MDAO JAPAN	2		2				1		5		4	5
JUSMAGKOREA	10	1	6	2	1		8	3	25	6	11	25
DAO MADAGASCAR		1								1		1
SAO MALAYSIA	1	1					1		2	1	1	2
JUSMAGPHIL	6	2	3	2	1		4		14	4	1	13
SAO SINGAPORE	1	1		1			1		2	2	1	
DAO SRI LANKA												1
JUSMAGTHAI	9	1	2	1	1		8	1	20	3	1	15
TOTAL	33	8	15	9	3	0	27	5	78	22	22	82

Classified by: US Pacific Command Digest(S/NF). Source marked OADR, dtd 15 Feb 1995.

UNCLASSIFIED
440

UNCLASSIFIED

USPACOM MATERIEL SUSTAINABILITY POSTURE
AS OF 30 SEPTEMBER 1994



APPENDIX II
LOGISTICS AND SECURITY ASSISTANCE
(B)(1) (1.4a)
(B)(1) (1.4g)

~~SECRET~~

Classified by: US Pacific Command Digest(S/NF). Source marked OADR, dtd 15 Feb 1995.

~~SECRET~~
441

Whole Page
1.5-19
(B)

USPACOM MATERIEL SUSTAINABILITY POSTURE (CONT.)
AS OF 30 SEPTEMBER 1994



(B)(1)(1.4a)
(B)(1)(1.4g)

~~SECRET~~

~~SECRET~~
442

Classified by: US Pacific Command Digest(S/NF). Source marked OADR, dtd 15 Feb 1995.



USPACOM MATERIEL SUSTAINABILITY POSTURE (CONT.)
AS OF 30 SEPTEMBER 1994

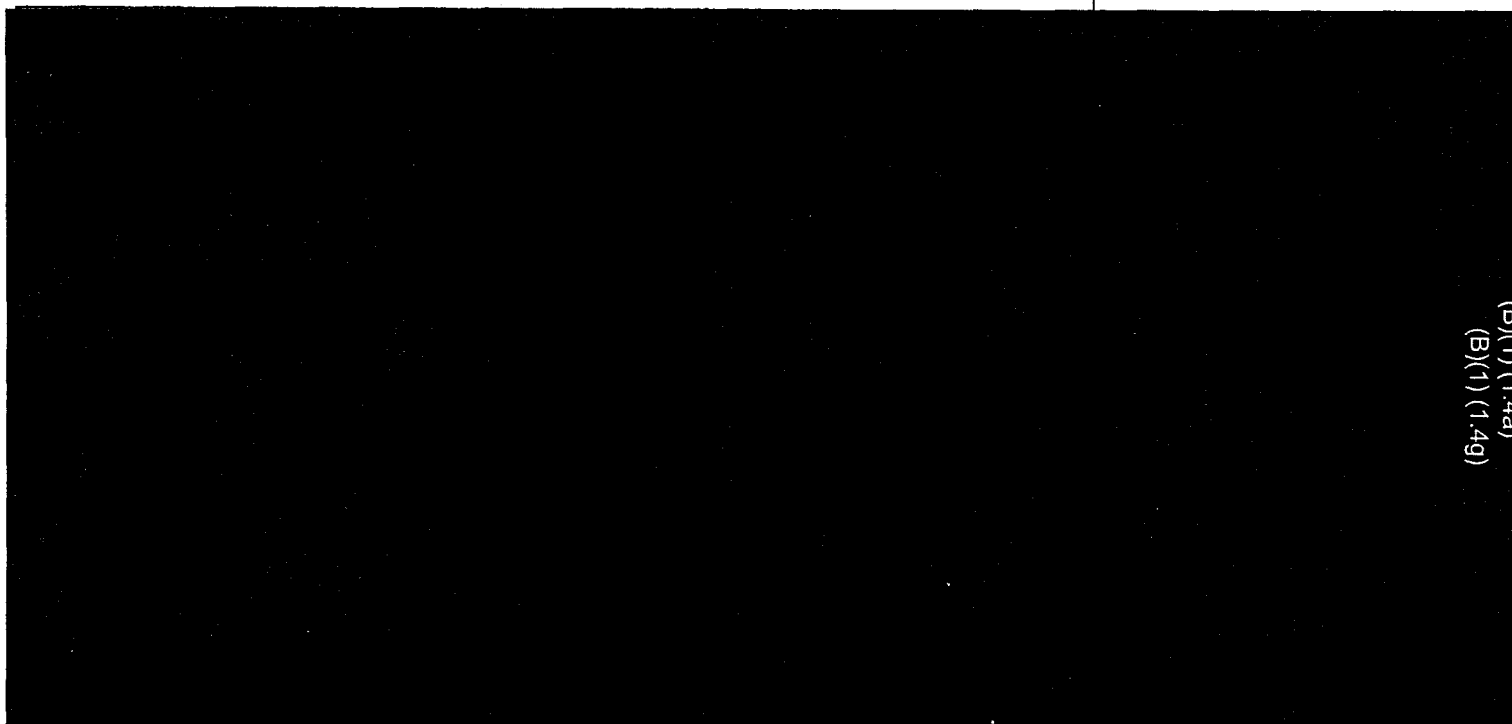

(B)(1) (1.4a)
(B)(1) (1.4g)

~~SECRET~~

Whole Page (S/NF)

Classified by: US Pacific Command Digest(S/NF). Source marked OADR, dtd 15 Feb 1995.

~~SECRET~~
443

Whole Page
1.5 (a)(9)

USPACOM MATERIEL SUSTAINABILITY POSTURE (CONT.)
AS OF 30 SEPTEMBER 1994



(B)(1) (1.4a)
(B)(1) (1.4g)

~~SECRET~~

~~SECRET~~
444

Classified by: US Pacific Command Digest(S/NF). Source marked OADR, dtd 15 Feb 1995.

L

BULK PETROLEUM DATA-USPACOM 1994 ISSUES AND RECEIPTS

USPACOM CY 1994 BULK PETROLEUM STATISTICS (IN THOUSANDS OF BARRELS)

LOCATION	RECEIPTS				TOTALS	Percent of Total Receipts
	JP4/JP8	JP5	DIESEL	MOGAS		
ALASKA/ALEUTIANS	2,067	126	0	0	2,193	11%
HAWAII	1,418	1,938	1,526	0	4,882	25%
MID-PAC ISLANDS	0	147	222	0	369	2%
GUAM	546	73	668	0	1,287	7%
JAPAN	3,628	1,346	2,405	360	7,739	40%
KOREA	1,025	0	0	30	1,055	5%
SINGAPORE	0	309	0	0	309	2%
DIEGO GARCIA	0	821	687	13	1,521	8%
TOTALS	8,684	4,760	5,508	403	19,355	
% of Total Receipts	45%	25%	28%	2%		

LOCATION	ISSUES				TOTALS	Percent of Total Issues
	JP4/JP8	JP5	DIESEL	MOGAS		
ALASKA/ALEUTIANS	2,195	100	113	9	2,417	12%
HAWAII	1,364	601	1,408	0	3,373	17%
MID-PAC ISLANDS	0	296	239	8	543	3%
GUAM	550	149	809	0	1,508	8%
JAPAN	3,658	1,227	2,223	414	7,522	39%
KOREA	1,510	0	458	37	2,005	10%
SINGAPORE	0	322	953	0	1,275	7%
DIEGO GARCIA	0	233	507	7	747	4%
TOTALS	9,277	2,928	6,710	475	19,390	
% of Total Issues	48%	15%	35%	2%		

1994 BULK FUEL RECEIPTS (ALL PRODUCTS)

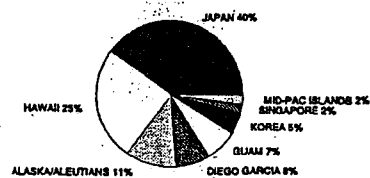

TOTAL RECEIPTS - 19,355 MBBLs

1994 BULK FUEL RECEIPTS (ALL LOCATIONS)

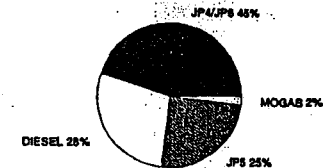

TOTAL RECEIPTS - 19,355 MBBLs

1994 BULK FUEL ISSUES (ALL PRODUCTS)

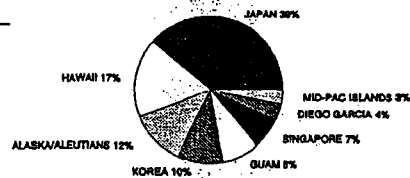

TOTAL ISSUES - 19,390 MBBLs

1994 BULK FUEL ISSUES (ALL LOCATIONS)

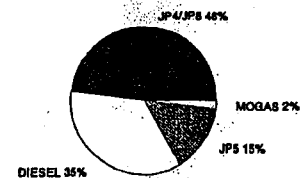

TOTAL ISSUES - 19,390 MBBLs

UNCLASSIFIED
445

UNCLASSIFIED

Classified by: US Pacific Command Digest(S/NF). Source marked OADR, dtd 15 Feb 1995.

BULK PETROLEUM DATA-USPACOM 1994 INVENTORY AND STORAGE CAPACITY

USPACOM CY 1994 BULK PETROLEUM STATISTICS (IN THOUSANDS OF BARRELS)

MONTHLY AVERAGE USABLE STORAGE CAPACITY

LOCATION	JP4/JP8	JP5	DIESEL	MOGAS	TOTALS	Percent of Total Avg. Cap.
ALASKA/ALEUTIANS	1,832	368	255	49	2,302	10%
HAWAII	364	2,514	685	1	3,544	15%
MID-PAC ISLANDS	0	515	98	19	630	3%
GUAM	1,755	276	833	0	2,864	12%
JAPAN	3,729	2,327	3,881	298	10,215	42%
KOREA	2,214	0	325	174	2,713	11%
SINGAPORE	0	636	392	0	1,028	4%
DIEGO GARCIA	0	588	308	14	910	4%
TOTALS	9,894	7,222	6,735	555	24,206	
% of Total Avg. Cap.	40%	30%	28%	2%		

MONTHLY AVERAGE BULK FUEL INVENTORIES

LOCATION	JP4/JP8	JP5	DIESEL	MOGAS	TOTALS	Percent of Total Avg. Inv.
ALASKA/ALEUTIANS	1,191	282	102	31	1,606	9%
HAWAII	279	1,697	446	1	2,423	14%
MID-PAC ISLANDS	0	341	47	10	398	2%
GUAM	1,095	209	442	0	1,746	10%
JAPAN	2,929	1,738	3,109	163	7,937	46%
KOREA	1,449	0	180	108	1,737	10%
SINGAPORE	0	508	199	0	707	4%
DIEGO GARCIA	0	482	213	9	704	4%
TOTALS	6,943	5,255	4,738	322	17,258	
% of Total Avg. Inv.	40%	30%	47%	2%		

1994 MONTHLY USABLE CAPACITY (ALL PRODUCTS)

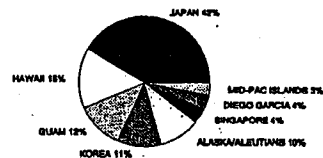

TOTAL MONTHLY AVG. CAP. - 24,206 MBBLs

1994 MONTHLY AVG. CAPACITY (ALL LOCATIONS)

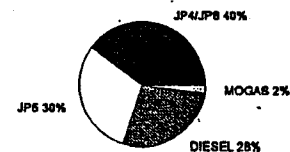

TOTAL MONTHLY AVG. CAP. - 24,206 MBBLs

1994 MONTHLY AVG. INVENTORY (ALL PRODUCTS)

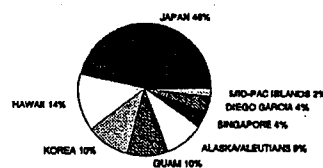

TOTAL MONTHLY AVG. INV. - 17,258 MBBLs

1994 MONTHLY AVG. INVENTORY (ALL LOCATIONS)

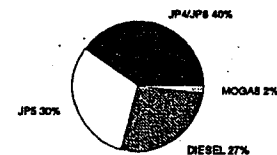

TOTAL MONTHLY AVG. INV. - 17,258 MBBLs

UNCLASSIFIED
446

UNCLASSIFIED

Classified by: US Pacific Command Digest(S/NF). Source marked OADR, dtd 15 Feb 1995.

PACIFIC MILITARY SEALIFT ROUTES

UNCLASSIFIED
447

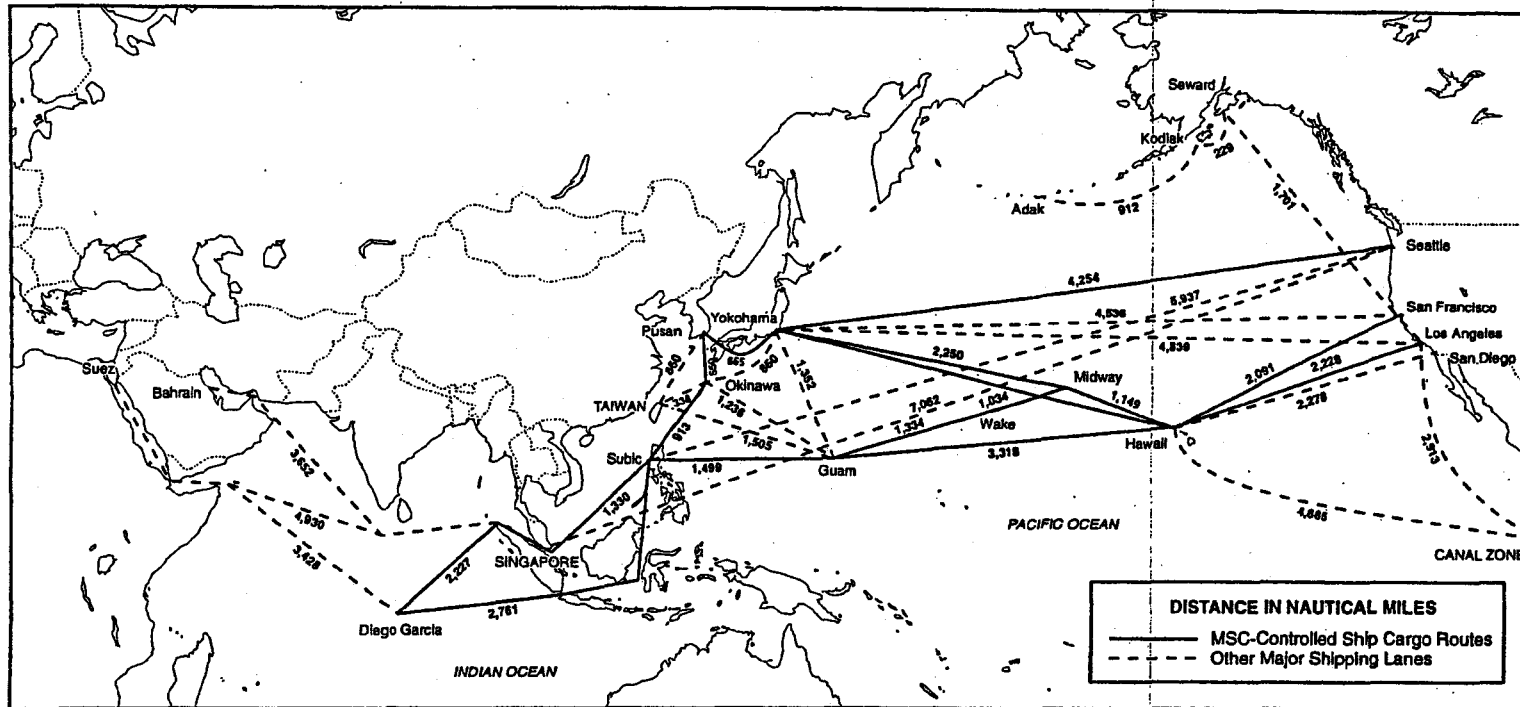

UNCLASSIFIED

NOTE: All routes shown are for purposes of distance, and not necessarily representative of specific routes regularly travelled.

Classified by: US Pacific Command Digest(S/NF). Source marked OADR, dtd 15 Feb 1995.

**PACIFIC AIRLIFT CHANNELS
AMC C-141/C-5**

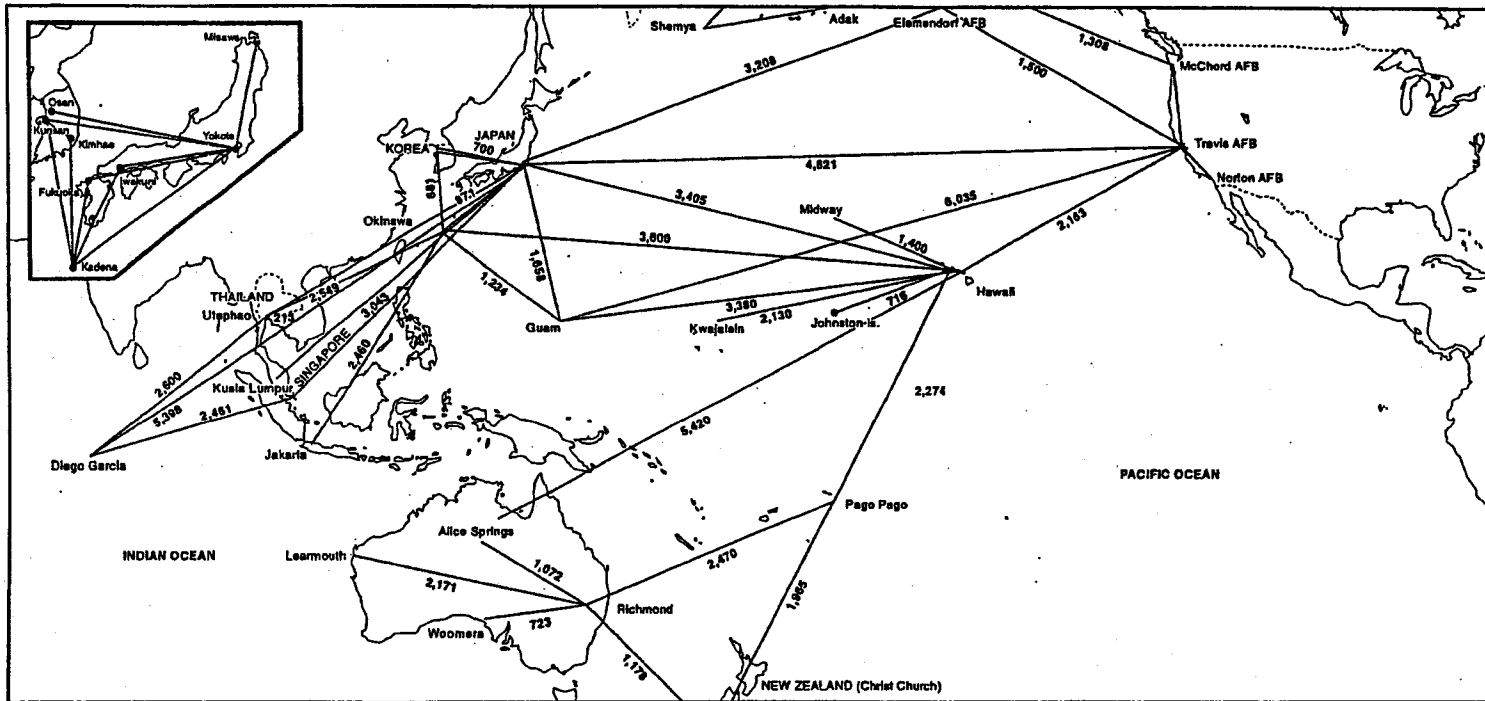

UNCLASSIFIED
448

UNCLASSIFIED

Classified by: US Pacific Command Digest(S/NF). Source marked OADR, dtd 15 Feb 1995.

PACIFIC AIRLIFT CHANNELS AMC C-130

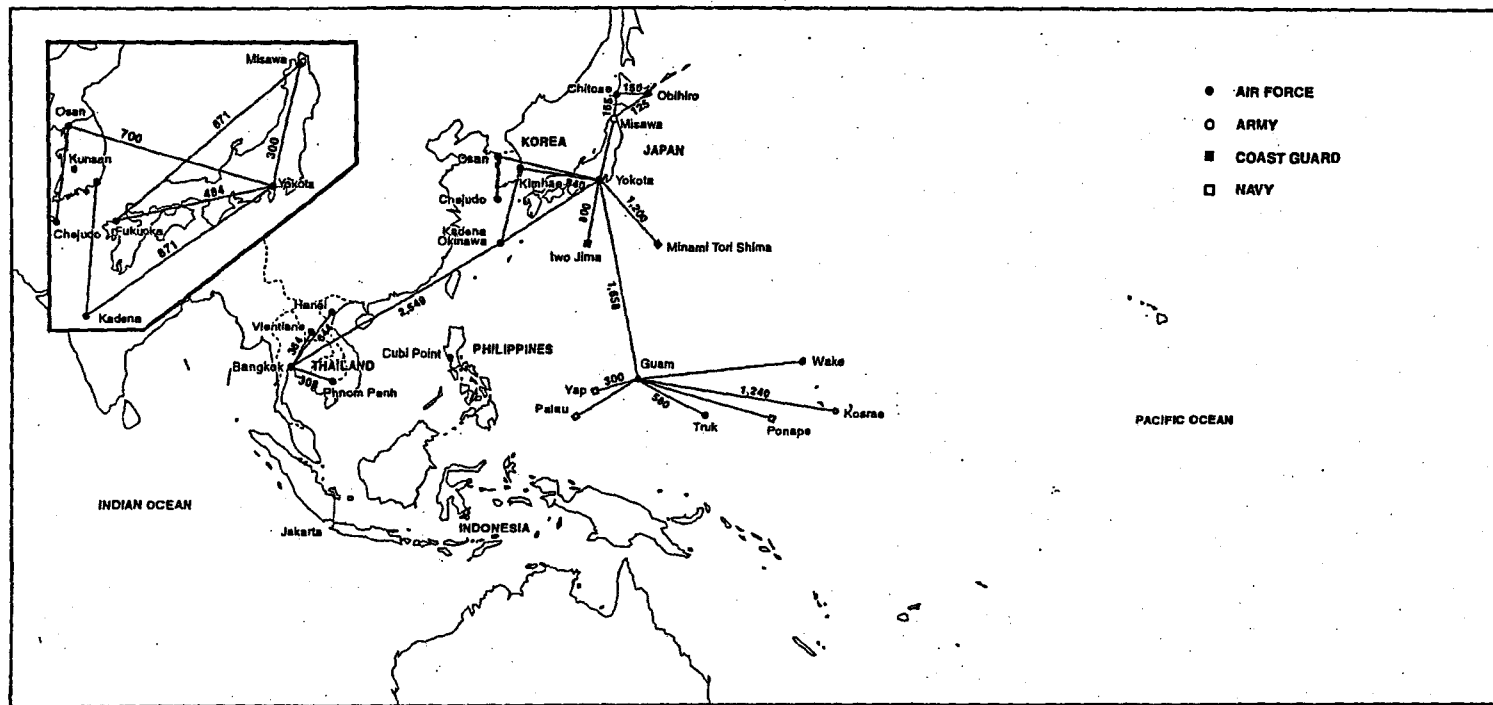

Classified by: US Pacific Command Digest(S/NF). Source marked OADR, dtd 15 Feb 1995.

UNCLASSIFIED
449

UNCLASSIFIED

**USPACOM SECURITY ASSISTANCE PROGRAM
FY 1995 BUDGET -- ADMINISTRATIVE COSTS (IN THOUSANDS)
AS OF 1 OCTOBER 1994**

ORGANIZATION	USCINCPAC SECURITY ASSISTANCE FUNDED	FOREIGN AFFAIRS ADMIN SUPPORT	TOTAL U.S. COSTS	HOST COUNTRY COSTS		GRAND TOTAL
				ASSISTANCE IN USD	CONTRIBUTED CURRENCY	
HO USCINCPAC	\$ 650.0	\$	\$ 650.0	\$	\$	\$ 650.0
CH FMS AUSTRALIA	114.3	6.2	120.5			120.5
DAO BANGLADESH	30.4	1.5	31.9			31.9
DAO BURMA	0		0			0
DAO CHINA	34.4		34.4			34.4
USCINCPACSWP FIJI	3.3		3.3			3.3
DSA INDIA	163.8	39.2	203.0			203.0
OMADP INDONESIA	568.1	164.2	732.3	502.3		1,234.6
MDO JAPAN	663.5	100.3	763.8	282.2	53.4	1,099.4
JUSMAGKOREA	2,585.8	169.0	2,754.8	1,061.8	1,013.9	4,830.3
DAO MADAGASCAR	0		0			0
DAO MALAYSIA	253.8	22.8	276.6			276.6
DAO NEPAL	23.1		23.1			23.1
DAO NEW ZEALAND	11.3		11.3			11.3
DAO PAPUA NEW GUINEA	0		0			0
JUSMAGPHIL	868.0	120.0	988	615.8		1,603.8
DAO SINGAPORE	151.1	14.8	165.7			165.7
DAO SRI LANKA	28.6	12.1	40.7			40.7
JUSMAGTHAI	1,042.1	49.2	1,091.3	476.2		1,567.5
UNDISTRIBUTED*	158.4		158.4			158.4
TOTAL	\$ 7,350.0	\$ 699.1	\$ 8,049.1	\$ 2,938.1	\$ 1,067.3	\$ 12,054.5

* Contributed currency is paid directly to the U.S. Government to offset U.S. costs and, therefore, is a non-add item.

Classified by: US Pacific Command Digest(S/NF). Source marked OADR, dtd 15 Feb 1995.

UNCLASSIFIED
450

UNCLASSIFIED

SECURITY ASSISTANCE PROGRAM (U)
(THOUSANDS OF DOLLARS)

COUNTRY	INTERNATIONAL MILITARY EDUCATION AND TRAINING PROGRAM			FMF	
	PROGRAM STATUS	FY94 FINAL STATUS	FY95 LEVEL	FY94 FINAL STATUS	FY95 LEVEL
BANGLADESH	Active	\$182	\$175		
BURMA	Susp 1988				
CAMBODIA	FY94 Start	\$122	\$200		
COMOROS	Active				
FIJI	Susp 1987				
INDIA	Active	\$152	\$200		
INDONESIA	Susp 1993				
KOREA	Active	\$21	\$10		
MADAGASCAR	Eligible				
MALAYSIA	FY94 Restart	\$318	\$500		
MALDIVES	Eligible		\$50		
MAURITIUS	Eligible				
MONGOLIA	Active	\$50	\$100		
NEPAL	Active	\$108	\$100		
PAPUA NEW GUINEA	Active	\$50	\$125		
PHILIPPINES	Active	\$876	\$1,195		
SEYCHELLES	Active				
SINGAPORE	Active	\$10	\$20		
SOLOMON ISLANDS	Active	\$8	\$100		
SRI LANKA	Active	\$100	\$100		
THAILAND	Active	\$895	\$1,000		
TONGA	Active	\$15	\$50		
VANUATU	Active	\$15	\$50		
WESTERN SAMOA	Active	\$15	\$50		
TOTAL		\$2,935	\$4,025		

Classified by: US Pacific Command Digest(S/NF). Source marked OADR, dtd 15 Feb 1995.

UNCLASSIFIED
451

UNCLASSIFIED

UNCLASSIFIED

THIS PAGE INTENTIONALLY LEFT BLANK

UNCLASSIFIED

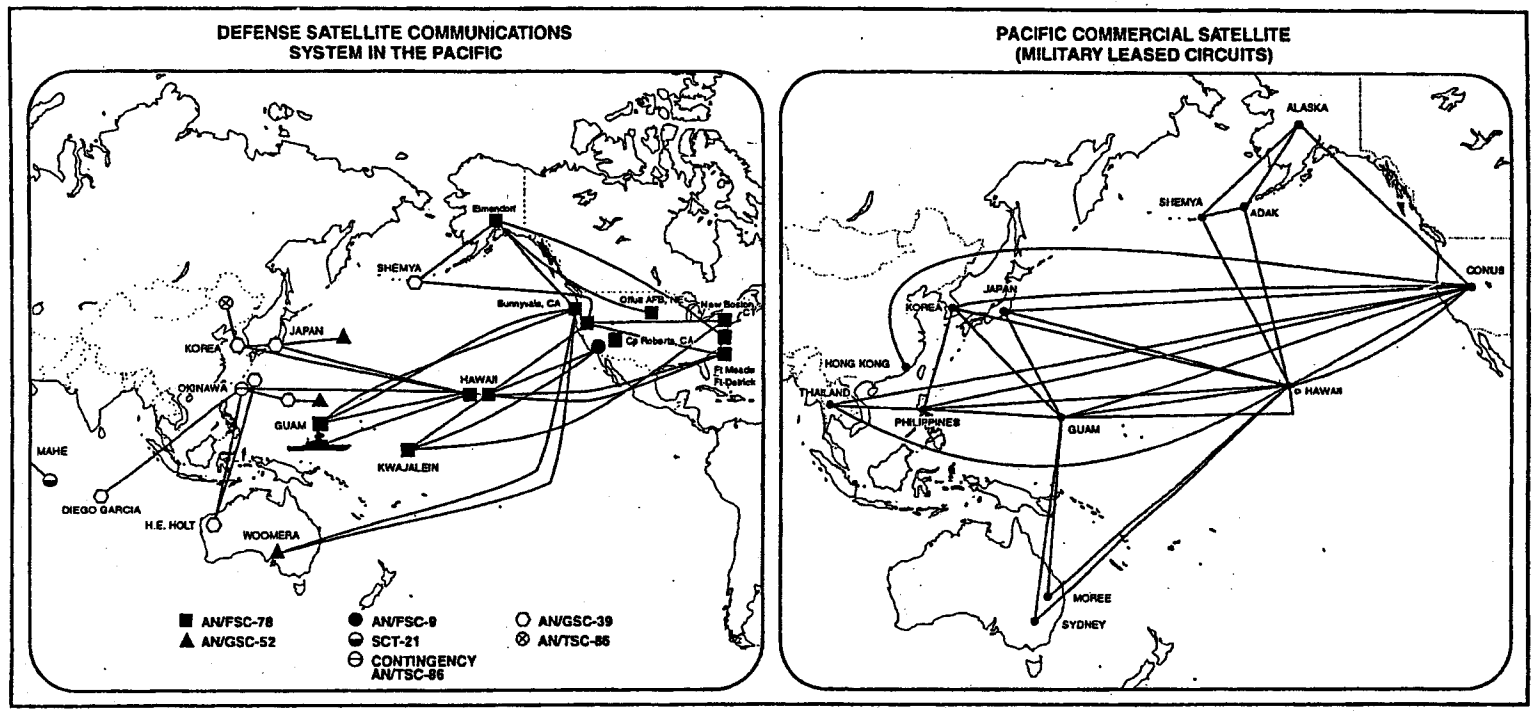

Classified by: US Pacific Command Digest(S/NF). Source marked OADR, dtd 15 Feb 1995.

UNCLASSIFIED
453

UNCLASSIFIED

UNCLASSIFIED
454

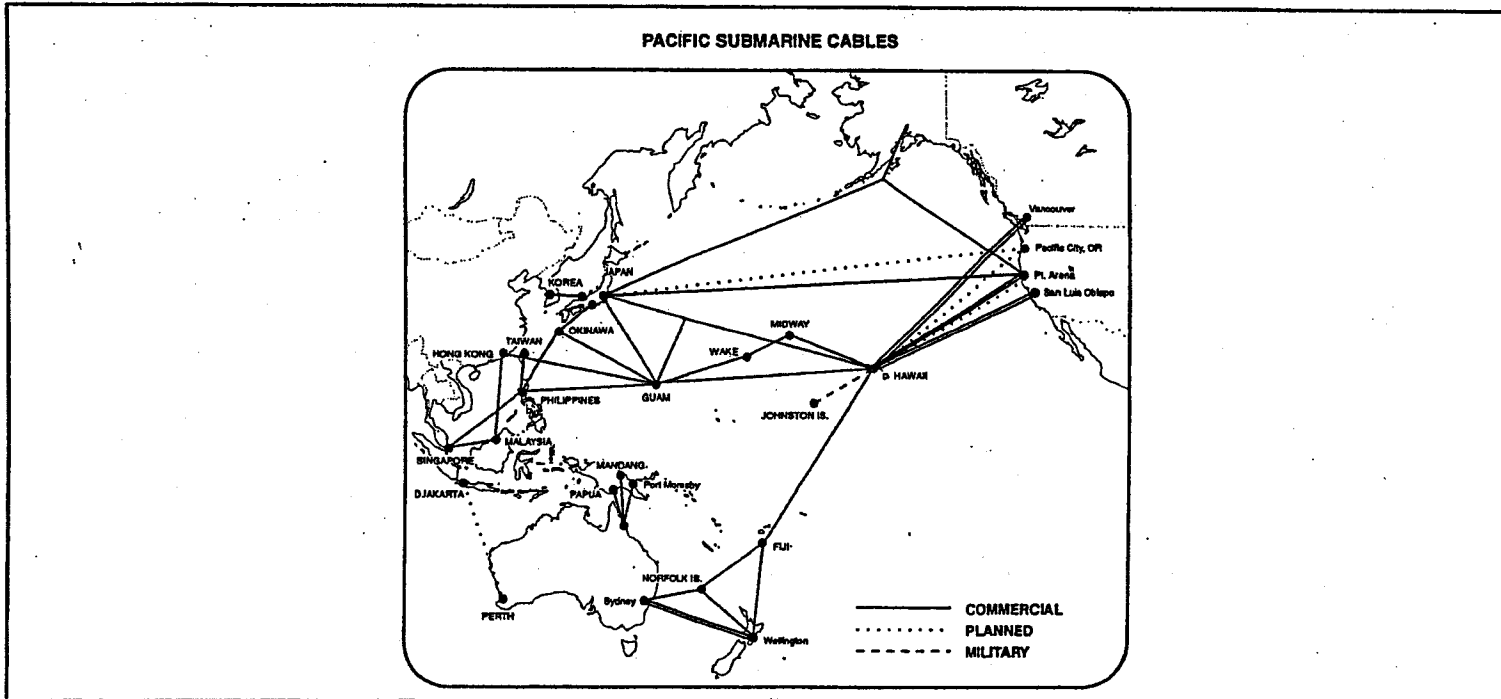

UNCLASSIFIED

Classified by: US Pacific Command Digest(S/NF). Source marked OADR, dtd 15 Feb 1995.

UNCLASSIFIED
455

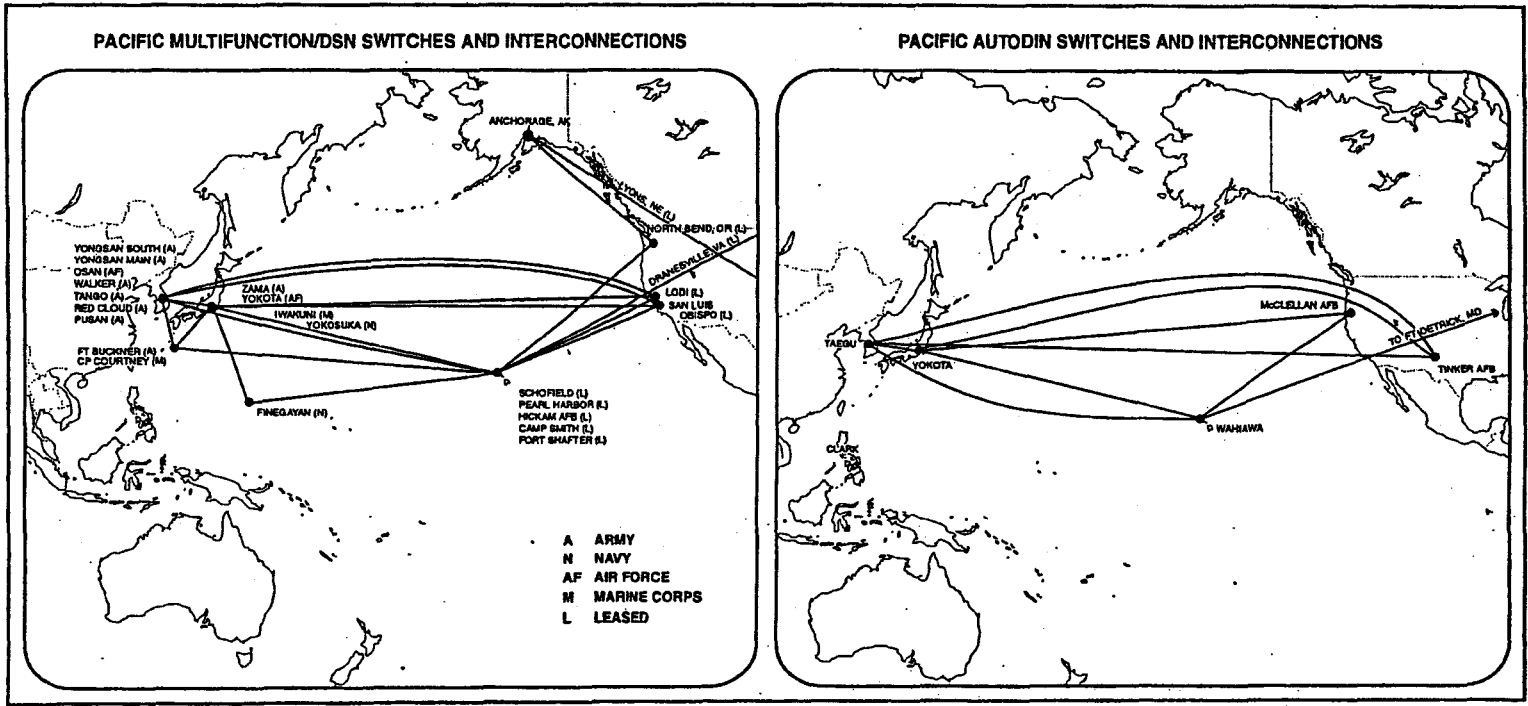

UNCLASSIFIED

Classified by: US Pacific Command Digest(S/NF). Source marked OADR, dtd 15 Feb 1995.

AIR FORCE SATELLITE COMMUNICATIONS SYSTEM (U)

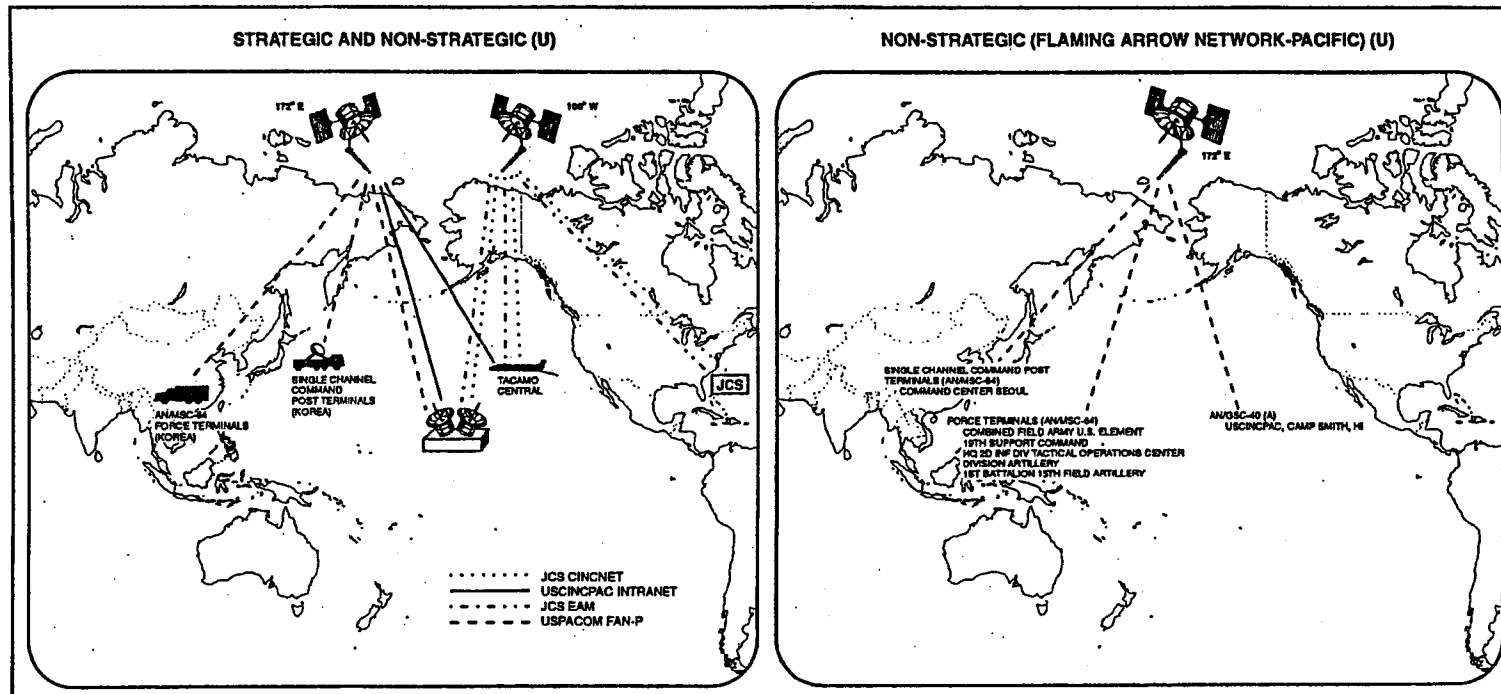

Classified by: US Pacific Command Digest(S/NF). Source marked OADR, dtd 15 Feb 1995.

UNCLASSIFIED
456

UNCLASSIFIED

USPACOM WWMCCS ADP/WIN/AUTODIN CIRCUIT NETWORK

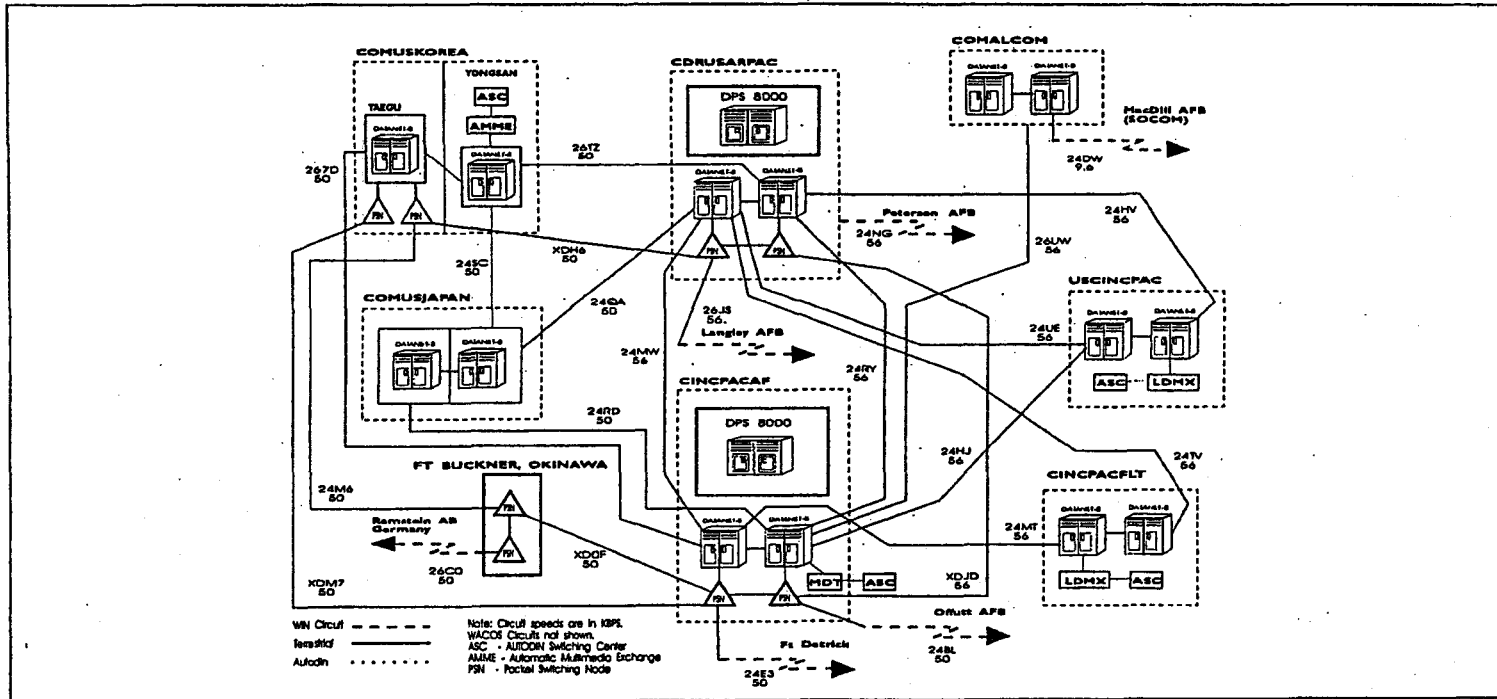

Classified by: US Pacific Command Digest(S/NF). Source marked OADR, dtd 15 Feb 1995.

UNCLASSIFIED
457

UNCLASSIFIED

UNCLASSIFIED

THIS PAGE INTENTIONALLY LEFT BLANK

UNCLASSIFIED

AUSTRALIA (U)

(U) BASIC INFORMATION

LAND AREA 7,617,930 Sq Km
 NATIONAL OCEAN CLAIMS:
 FISHING ZONE 200 Nautical Miles
 SECURITY ZONE None Claimed
 CONTIGUOUS ZONE 24 Nautical Miles
 TERRITORIAL SEA 12 Nautical Miles
 POPULATION 18,000,000
 ANNUAL GROWTH 1.38 Percent
 LITERACY RATE 98-100 Percent
 LIFE EXPECTANCY 74 yrs (male), 80 yrs (female)
 GROSS DOMESTIC PRODUCT \$ 293.5 Billion
 PER CAPITA \$ 16,700
 DEFENSE BUDGET \$ 8.02 Billion
 OF TOTAL GOVERNMENT BUDGET 5.9 Percent
 TYPE GOVERNMENT Federal Parliamentary State within the Commonwealth recognizing Queen Elizabeth II as Sovereign or Head of State

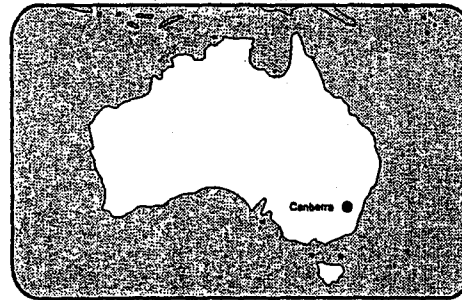

GOVERNOR GENERAL William HAYDEN
 PRIME MINISTER Paul KEATING
 MINISTER FOR FOREIGN AFFAIRS AND TRADE Gareth EVANS
 MINISTER FOR DEFENCE Robert RAY
 CHIEF OF THE DEFENCE FORCE ADM Alan L. BEAUMONT
 CHIEF OF GENERAL STAFF, ARMY LTG John GREY
 CHIEF OF THE NAVAL STAFF VADM Rodney G. TAYLOR
 CHIEF OF THE AIR STAFF AM L. B. FISHER

(U) U.S. KEY STAFF PERSONNEL

AMBASSADOR Hon. Edward J. PERKINS
 USCINCPACREP AUSTRALIA and
 DATT Col Stephen E. BARNEYBACK, USAF
 CHIEF, OFFICE OF DEFENSE
 COOPERATION Col Michael E. SCOTT, USAF

APPENDIX IV
 COUNTRY SUMMARIES

~~SECRET~~

(B)(1)(1.4a)
 (B)(1)(1.4b)
 (B)(1)(1.4d)

(B)(1)(1.4a)
 (B)(1)(1.4b)
 (B)(1)(1.4d)

~~SECRET~~
 459

Classified by: US Pacific Command Digest(S/NF). Source marked OADR, dtd 15 Feb 1995.

ENTRUST APPENDIX
 PP 459-492

BANGLADESH (U)

(U) BASIC INFORMATION

TOTAL AREA 143,998 Sq Km
 LAND AREA 133,810 Sq Km
 NATIONAL OCEAN CLAIMS:^a
 ECONOMIC ZONE 200 Nautical Miles
 FISHING ZONE 200 Nautical Miles
 SECURITY ZONE 18 Nautical Miles
 TERRITORIAL SEA 12 Nautical Miles
 Straight baselines claimed:
 POPULATION 125,149,469
 ANNUAL GROWTH 2.33 Percent
 LITERACY RATE 35 Percent
 LIFE EXPECTANCY 53 Years
 GROSS NATIONAL PRODUCT (1993 est) \$ 122 Billion
 PER CAPITA \$ 210
 DEFENSE BUDGET \$ 355 Million
 OF TOTAL GROSS DOMESTIC BUDGET 1.5 Percent
 TYPE GOVERNMENT Republic
 (British Commonwealth)

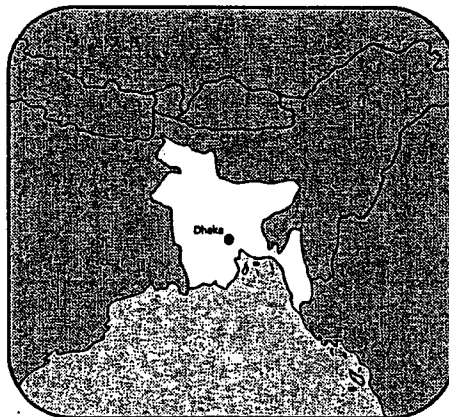

PRIME MINISTER AND
 MINISTER OF DEFENSE Begum Khaleda ZIA ur Rahman
 MINISTER OF FOREIGN AFFAIRS A. S. M. MUSTAFIZUR Rahman
 CHIEF OF ARMY STAFF LTG Abu Saleh Mohammad NASIM
 CHIEF OF NAVAL STAFF RADM Muhammad Muhaiminul ISLAM
 CHIEF OF AIR STAFF AVM Altai Hussain CHOWDHURY

^a The United States recognizes neither the claimed requirement to obtain prior permission for warship transit through the claimed territorial sea, nor the claimed assertion of jurisdiction relating to security within the contiguous zone.

(U) U.S. KEY STAFF PERSONNEL

AMBASSADOR Hon. David A. MERRILL
 DATT LTC James A. DUNN, Jr., USA

(B)(1) (1.4a)
 (B)(1) (1.4b)
 (B)(1) (1.4d)

(B)(1) (1.4a)
 (B)(1) (1.4b)
 (B)(1) (1.4d)

SECRET
 460

SECRET

Classified by: US Pacific Command Digest(S/NF). Source marked OADR, dtd 15 Feb 1995.

BRUNEI (U)

(U) BASIC INFORMATION

LAND AREA 5,270 Sq Km
 NATIONAL OCEAN CLAIMS:
 ECONOMIC ZONE* None Claimed
 FISHING ZONE* 200 Nautical Miles
 SECURITY ZONE None Claimed
 TERRITORIAL SEA* 12 Nautical Miles
 POPULATION 250,000
 ANNUAL GROWTH 2.9 Percent
 LITERACY RATE 77 Percent
 LIFE EXPECTANCY 71 Years
 GROSS DOMESTIC PRODUCT \$ 3.5 Billion
 PER CAPITA \$ 9,900
 DEFENSE BUDGET \$ 255 Million
 OF GROSS DOMESTIC PRODUCT 7.1 Percent
 TYPE GOVERNMENT Constitutional Sultanate controlled
 and governed by a Paramount Ruler
 (British Commonwealth)

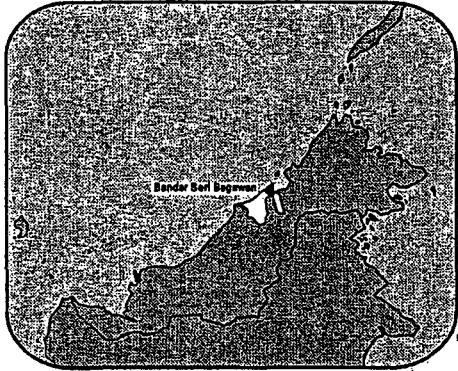

SULTAN, PRIME MINISTER, AND DEFENCE MINISTER
 H.H. Paduka Seri Beginda Hassanal BOLKIAH Muizzaddin Waddaulah
 MINISTER OF FOREIGN AFFAIRS Mohamad BOLKIAH
 COMMANDER, ROYAL BRUNEI ARMED FORCES Pehin MG MYSIN
 COMMANDER, ROYAL BRUNEI LAND FORCES Pehin BG SHARI
 COMMANDER, ROYAL BRUNEI NAVY Pehin COL Haji KEFLI
 COMMANDER, ROYAL BRUNEI AIR FORCES
 Pengiran Dato Seri Laila Jasa BG ABIDIN bin Pengiran Ahmad

* Maritime boundary agreed with Malaysia.

(U) U.S. KEY STAFF PERSONNEL

AMBASSADOR Hon. Theresa A. TULL
 DATT* COL Richard D. WELKER, USA

* Resides in Singapore, where he serves as ARMA Singapore.

SECRET
461

(B)(1) (1.4d)
(B)(1) (1.4a)
(B)(1) (1.4b)

(B)(1) (1.4a)
(B)(1) (1.4b)
(B)(1) (1.4d)

SECRET

BURMA (MYANMAR) (U)

(U) BASIC INFORMATION

LAND AREA 657,740 Sq Km
 NATIONAL OCEAN CLAIMS:
 ECONOMIC ZONE 200 Nautical Miles
 FISHING ZONE 200 Nautical Miles
 SECURITY ZONE 24 Nautical Miles
 TERRITORIAL SEA 12 Nautical Miles
 Straight baselines claimed (Including range of
 up to 223.3 NM to the Gulf of Martaban)
 POPULATION 42,112,082
 ANNUAL GROWTH 2.0 Percent
 LITERACY RATE 81 Percent
 LIFE EXPECTANCY 55 Years
 GROSS NATIONAL PRODUCT \$ 11 Billion
 PER CAPITA (1992) \$ 250
 DEFENSE BUDGET (1991) \$ 800 Million
 OF CENTRAL GOVERNMENT BUDGET 3.7 Percent
 TYPE GOVERNMENT Military Junta - STATE LAW AND ORDER
 RESTORATION COUNCIL (SLORC)
 headed by GEN THAN SHWE

 PRIME MINISTER, SLORC CHAIRMAN GEN THAN SHWE
 MINISTER OF FOREIGN AFFAIRS U CHN GYAW
 MINISTER OF DEFENSE GEN THAN SHWE
 COMMANDER IN CHIEF ARMED FORCES GEN THAN SHWE
 COMMANDER IN CHIEF ARMY LTG MAUNG AYE
 COMMANDER IN CHIEF NAVY VADM THAN NYUNT
 COMMANDER IN CHIEF AIR FORCE Lt Gen THEIN WIN

* The United States recognizes neither the claimed requirement to obtain prior permission for warship transit through the claimed territorial sea, nor the claimed assertion of jurisdiction within the contiguous zone, nor the claimed straight baselines.

(U) U.S. KEY STAFF PERSONNEL

CHARGE Ms. Marilyn MEYERS
 DATT COL Danwil A. LEE, USA
 Air Attache Col Steven D. RIENTS, USAF

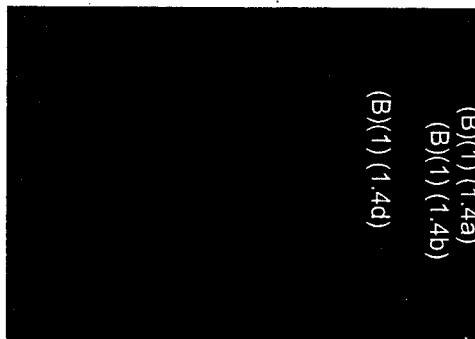

(B)(1) (1.4d)

(B)(1) (1.4a)
(B)(1) (1.4b)

(B)(1) (1.4a)
(B)(1) (1.4b)
(B)(1) (1.4d)

Burma

~~SECRET~~

~~SECRET~~
462

Classified by: US Pacific Command Digest(S/NF). Source marked OADR, dtd 15 Feb 1995.

CAMBODIA (U)

(U) BASIC INFORMATION

LAND AREA 176,520 Sq Km
NATIONAL OCEAN CLAIMS:
ECONOMIC ZONE 200 Nautical Miles
TERRITORIAL WATERS 12 Nautical Miles
DISPUTES Maritime boundary with Vietnam
and Burma not defined
POPULATION 8.6 Million
ANNUAL GROWTH 2.2 Percent
RELIGION 95% Theravada Buddhist, 5% Other
GROSS DOMESTIC PRODUCT \$ 1.28 Billion
PER CAPITA \$ 200
TYPE GOVERNMENT Royal National Government of Cambodia,
Constitutional Monarchy,
Constitutional Appointed King
KING OF CAMBODIA King Norodom SIHANOUK
FIRST PRIME MINISTER Prince Norodom RANARIDDH
SECOND PRIME MINISTER Hun SEN
DEPUTY PRIME MINISTER Ing KIETH
DEPUTY PRIME MINISTER Sar KENG
NATIONAL ASSEMBLY CHAIRMAN Chea SIM
FIRST VICE CHAIRMAN Loy SIMCHHEANG
SECOND VICE CHAIRMAN Son SOUBERT
ROYAL CAMBODIAN ARMED FORCES
CHIEF OF GENERAL STAFF Ke KIMYAN

(U) U.S. KEY STAFF PERSONNEL

AMBASSADOR Hon. Charles TWINING
USCINCPACREP Phnom Penh LTC Barry SHAPIRO, USA

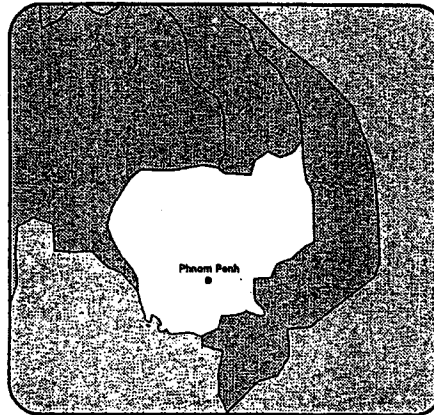

(B)(1)
(1.4a)
(B)(1)
(1.4b)
(B)(1)
(1.4d)

(B)(1) (1.4a)
(B)(1) (1.4b)
(B)(1) (1.4d)

~~SECRET~~
463

~~SECRET~~

Classified by: US Pacific Command Digest(S/NF). Source marked OADR, dtd 15 Feb 1995.

CHINA (U)

(U) BASIC INFORMATION

LAND AREA 9,600,000 Sq Km
NATIONAL OCEAN CLAIMS:
ECONOMIC ZONE Portions of the East China Sea
and the Yellow Sea
FISHING ZONE None Claimed
SECURITY ZONE None Claimed
TERRITORIAL SEA 12 Nautical Miles
Straight baselines claimed
POPULATION 1,170,000,000
ANNUAL GROWTH 1.3 Percent
LITERACY RATE 73 Percent
LIFE EXPECTANCY About 70 Years
GROSS DOMESTIC PRODUCT \$ 2.61 Trillion
PER CAPITA \$ 2,200
DEFENSE BUDGET \$ 12 Billion Estimated
OF TOTAL GOVERNMENT BUDGET 8.7 Percent
TYPE GOVERNMENT Communist State

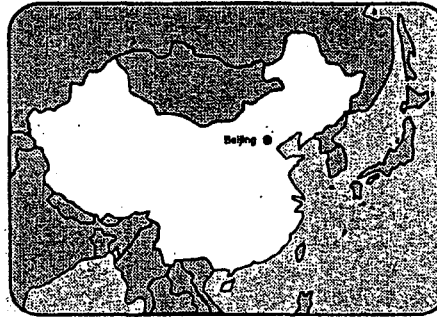

PARTY GENERAL SECRETARY JIANG Zemin
PRESIDENT JIANG Zemin
CHAIRMAN NATIONAL PEOPLE'S CONGRESS QIAO SHI
PREMIER LI Peng
MINISTER OF FOREIGN AFFAIRS QIAN Qichen
MINISTER OF NATIONAL DEFENSE CHI Haotian
CHAIRMAN OF CENTRAL MILITARY COMMISSION** JIANG Zemin
CHIEF OF THE GENERAL STAFF ZHANG Wannian
COMMANDER, PLA NAVY ZHANG Lianzhong
COMMANDER, PLA AIR FORCE YU Zhenwu

* The United States does not recognize the claimed requirement to obtain prior permission for warship transit through the claimed territorial sea.
DENG Xiaoping, although officially retired, remains the most powerful individual in both the government and Communist Party.

(U) U.S. KEY STAFF PERSONNEL

AMBASSADOR Hon. J. Stapleton ROY
DATT BG Michael T. BYRNES, USA

(U) MAJOR COUNTRY FORCES AND COMBAT CAPABILITY

See Other Far East Forces.

(B)(1) (1.4d)

CONFIDENTIAL

464

CONFIDENTIAL

Classified by: US Pacific Command Digest(S/NF). Source marked OADR, dtd 15 Feb 1995.

COMOROS (U)

(U) BASIC INFORMATION

LAND AREA 2,170 Sq Km
NATIONAL OCEAN CLAIMS:
ECONOMIC ZONE 200 Nautical Miles
FISHING ZONE 200 Nautical Miles
TERRITORIAL SEA 12 Nautical Miles
POPULATION 493,853
ANNUAL GROWTH 3.5 Percent
LITERACY RATE 48 Percent
LIFE EXPECTANCY 57 Years
GROSS DOMESTIC PRODUCT \$ 245 Million
PER CAPITA \$ 530
DEFENSE BUDGET NA
OF TOTAL GOVERNMENT BUDGET NA
TYPE GOVERNMENT Independent Republic

PRESIDENT AND
PRESIDENT OF THE SUPREME COURT Said Moehammad DJOHAR
PRIME MINISTER Ibrahim HALIDI
MINISTER OF FOREIGN AFFAIRS
AND COOPERATION Mlars MAECHA
DIRECTOR OF PRESIDENTIAL
CABINET IN CHARGE OF DEFENSE Commandant Ali MLANAHI

(U) U.S. KEY STAFF PERSONNEL

AMBASSADOR* Hon. Leslie M. ALEXANDER

* Resides in Port Louis, Mauritius.

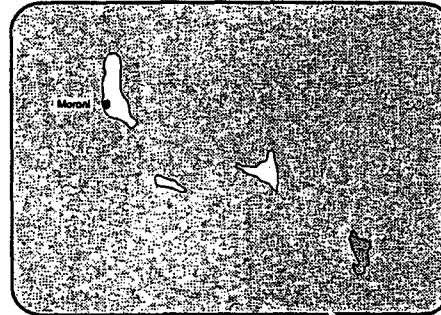

(B)(1) (1.4a)
(B)(1) (1.4b)



(B)(1) (1.4d)

SECRET
465

SECRET

Classified by: US Pacific Command Digest(S/NF). Source marked OADR, dtd 15 Feb 1995.

FIJI (U)

(U) BASIC INFORMATION

LAND AREA 18,270 Sq Km
 NATIONAL OCEAN CLAIMS:
 ECONOMIC ZONE 200 Nautical Miles
 FISHING ZONE 200 Nautical Miles
 SECURITY ZONE None Claimed
 TERRITORIAL SEA 12 Nautical Miles
 Straight baselines claimed
 POPULATION 756,000
 ANNUAL GROWTH09 Percent
 LITERACY RATE 88 Percent
 LIFE EXPECTANCY 82 yrs. (male), 67 yrs. (female)
 GROSS DOMESTIC PRODUCT \$ 3.0 Billion
 PER CAPITA \$ 4,000
 DEFENSE BUDGET \$ 22.4 Million
 OF TOTAL GOVERNMENT BUDGET 5.4 Percent
 TYPE GOVERNMENT Republic



PRESIDENT Ratu Sir Kamisese MARA
 PRIME MINISTER Sitiveni RABUKA
 MINISTER OF FOREIGN AFFAIRS Filipe SOLE
 COMMANDER, ROYAL FIJI
 MILITARY FORCES BG Ratu Epeli GANILAU

* Fiji's maritime claims are measured from straight baselines connecting the outermost points of the outermost islands.

(U) U.S. KEY STAFF PERSONNEL

AMBASSADOR Hon. Bruce GRAY
 USCINCPACREP FIJI
 and DATT LtCol Kip J. NAUGLE, USMC

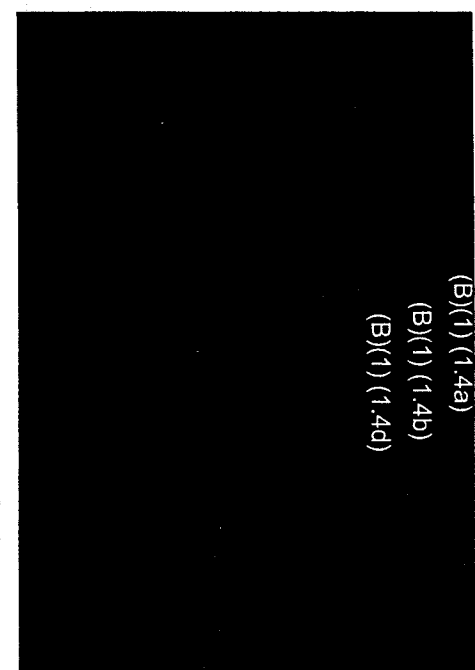

(B)(1) (1.4a)
 (B)(1) (1.4b)
 (B)(1) (1.4d)

(B)(1) (1.4d)

~~SECRET~~

466
~~SECRET~~

Classified by: US Pacific Command Digest(S/NF). Source marked OADR, dtd 15 Feb 1995.

INDIA (U)

(U) BASIC INFORMATION

LAND AREA 3,287,590 Sq Km
NATIONAL OCEAN CLAIMS:
ECONOMIC ZONE 200 Nautical Miles
FISHING ZONE 200 Nautical Miles
SECURITY ZONE 24 Nautical Miles
TERRITORIAL SEA 12 Nautical Miles
POPULATION 919,903,056
ANNUAL GROWTH 1 Percent
LITERACY RATE 48 Percent
LIFE EXPECTANCY 58 Male, 59 Female
GROSS DOMESTIC PRODUCT \$ 1.7 Trillion
PER CAPITA \$ 380
DEFENSE BUDGET \$ 5.8 Billion
OF TOTAL GOVERNMENT BUDGET 2.4 Percent
TYPE GOVERNMENT Federal Republic
(British Commonwealth based)

PRESIDENT Shanker Dayal SHARMA
PRIME MINISTER P. V. Narasimha RAO
MINISTER OF DEFENSE Vacant
FOREIGN MINISTER Dinash SINGH
CHIEF OF ARMY STAFF GEN Roy CHOWDHURY
CHIEF OF NAVAL STAFF ADM Vgal Singh SHEKWAWAT
CHIEF OF AIR STAFF ACM Swaroop Krishna KAUL

* The United States does not recognize the claimed requirement to obtain prior permission for warship transit through the claimed territorial sea.

(U) U.S. KEY STAFF PERSONNEL (U)

AMBASSADOR Hon. Frank G. WISNER
DATT COL Russell V. OLSON, USA
DSA Col Walter T. EASTHAM, USAF

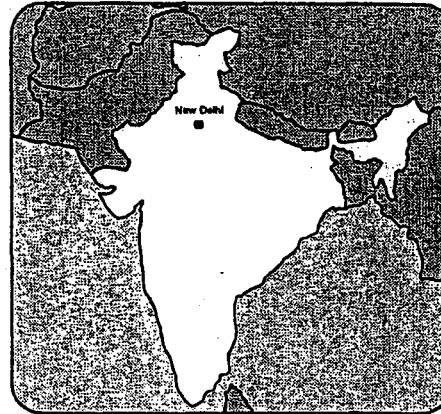

(B)(1) (1.4d)

(B)(1) (1.4b)

(B)(1) (1.4a)

SECRET
467

SECRET

Classified by: US Pacific Command Digest(S/NF). Source marked OADR, dtd 15 Feb 1995.

INDONESIA (U)

(U) BASIC INFORMATION

LAND AREA 1,919,440 Sq Km
NATIONAL OCEAN CLAIMS:
ECONOMIC ZONE 200 Nautical Miles
FISHING ZONE 200 Nautical Miles
SECURITY ZONE Certain Areas
TERRITORIAL SEA 12 Nautical Miles
POPULATION 195,683,531
ANNUAL GROWTH 1.7 Percent
LITERACY RATE 77 Percent
LIFE EXPECTANCY 61 Years
GROSS NATIONAL PRODUCT \$ 122 Billion
PER CAPITA \$ 630
DEFENSE BUDGET \$ 1.7 Billion
OF GROSS NATIONAL PRODUCT 2.1 Percent
TYPE GOVERNMENT Republic, President, Cabinet,
Unicameral Legislature

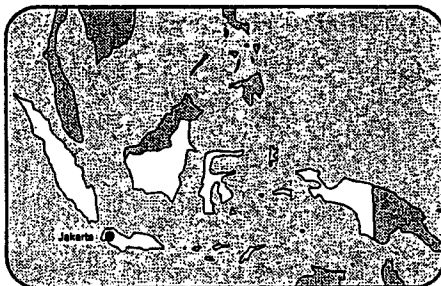

PRESIDENT SUHARTO
MINISTER FOR DEFENSE AND SECURITY EDY SUDRAJAT
MINISTER FOR FOREIGN AFFAIRS ALI ALATAS
CHIEF ARMED FORCES GEN Falsal TANJUNG
ARMY CHIEF OF STAFF GEN Arismunandar WISMOYO
NAVY CHIEF OF STAFF ADM Tanto KUSWANTO
AIR FORCE CHIEF OF STAFF A. M. Rho PAMBUDI

(U) U.S. KEY STAFF PERSONNEL

AMBASSADOR Hon. Robert L. BARRY
DATT COL Charles D. MCFETRIDGE, USA
MADP COL Karl F. EICKEMEYER, USA

(B)(1) (1.4d)

(B)(1) (1.4a)
(B)(1) (1.4b)

~~SECRET~~
468

~~SECRET~~

Classified by: US Pacific Command Digest(S/NF). Source marked OADR, dtd 15 Feb 1995.

JAPAN (U)

(U) BASIC INFORMATION

LAND AREA 378,000 Sq Km
NATIONAL OCEAN CLAIMS*
ECONOMIC ZONE None Claimed
FISHING ZONE 200 Nautical Miles
SECURITY ZONE None Claimed
TERRITORIAL SEA 12 Nautical Miles
POPULATION 124,480,000
ANNUAL GROWTH 0.4 Percent
LITERACY RATE 99 Percent
LIFE EXPECTANCY 80 Years
GROSS DOMESTIC PRODUCT \$ 3.06 Trillion
PER CAPITA \$ 22,000
DEFENSE BUDGET \$ 37.1 Billion
OF TOTAL GOVERNMENT BUDGET 8.2 Percent
TYPE GOVERNMENT Parliamentary Democracy

EMPEROR AKIHIHO
PRIME MINISTER MURAYAMA Tomichi
DIRECTOR GENERAL,
JAPAN DEFENSE AGENCY TAMAZAWA Tokuchiro
MINISTER OF FOREIGN AFFAIRS YOHEI Kono
CHAIRMAN, JOINT STAFF COUNCIL GEN NISHIMOTO Tetsuya
CHIEF OF GROUND (ARMY) STAFF GEN TOMIZAWA Kitaru
CHIEF OF MARITIME (NAVY) STAFF ADM FUKUCHI Takeo
CHIEF OF AIR (AIR FORCE) STAFF Gen SUGIYAMA Shigeru

* Japan only claims a 3 nautical mile territorial sea in the Soya, Tsugaru, Osumi, and Tsushima Straits.

(U) U.S. KEY STAFF PERSONNEL

AMBASSADOR Hon. Walter F. MONDALE
COMUSJAPAN U Gen Richard B. MYERS, USAF
CHMDO Col Thomas BROWN, USAF
DATT CAPT J. Stephen FITZGERALD, USN

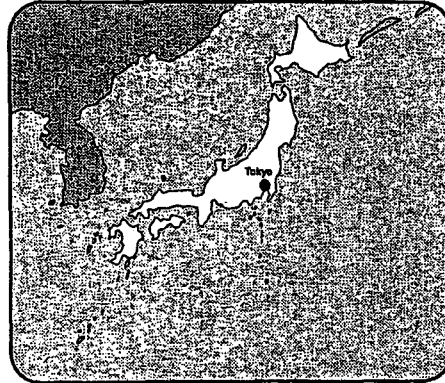

(B)(1)(1.4d)

(B)(1)(1.4a)
(B)(1)(1.4b)

469

~~SECRET~~

~~SECRET~~

Classified by: US Pacific Command Digest(S/NF). Source marked OADR, dtd 15 Feb 1995.

KOREA, REPUBLIC OF (U)

(U) BASIC INFORMATION

LAND AREA 98,190 Sq Km
 NATIONAL OCEAN CLAIMS:^{*}
 ECONOMIC ZONE 200 Nautical Miles
 FISHING ZONE Agreed Boundaries
 SECURITY ZONE None Claimed
 TERRITORIAL SEA 12 Nautical Miles
 POPULATION 44,149,199
 ANNUAL GROWTH 1.1 Percent
 LITERACY RATE 98 Percent
 LIFE EXPECTANCY 70 Years
 GROSS NATIONAL PRODUCT \$ 328 Billion
 PER CAPITA \$ 7,430
 DEFENSE BUDGET \$ 11.9 Billion
 OF GROSS NATIONAL PRODUCT 3.7 Percent
 OF TOTAL GOVERNMENT BUDGET 25.16 Percent
 TYPE GOVERNMENT Republic

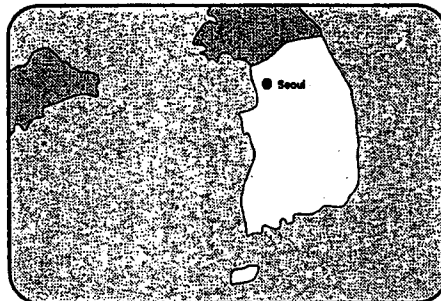

PRESIDENT KIM Young Sam
 PRIME MINISTER LEE Hong Koo
 MINISTER OF FOREIGN AFFAIRS GONG Ro Myung
 MINISTER OF NATIONAL DEFENSE LEE Yang Ho
 CHAIRMAN, JOINT CHIEFS OF STAFF GEN KIM Dong Jin
 CHIEF OF STAFF, ARMY GEN YOON Yong Nam
 CHIEF OF STAFF, AIR FORCE GEN CHO Kun Hae
 CHIEF OF NAVAL OPERATIONS VADM KIM Hong Yol

* The United States does not recognize the requirement for prior notification for warship transit through the claimed territorial sea.

(U) U.S. KEY STAFF PERSONNEL

AMBASSADOR Hon. James LANEY
 COMUSKOREA GEN Gary E. LUCK, USA
 CHIEF, JUSMAG-K COL Keith L. YOUNG, USA
 DATT COL William R. MCKINNEY, USA

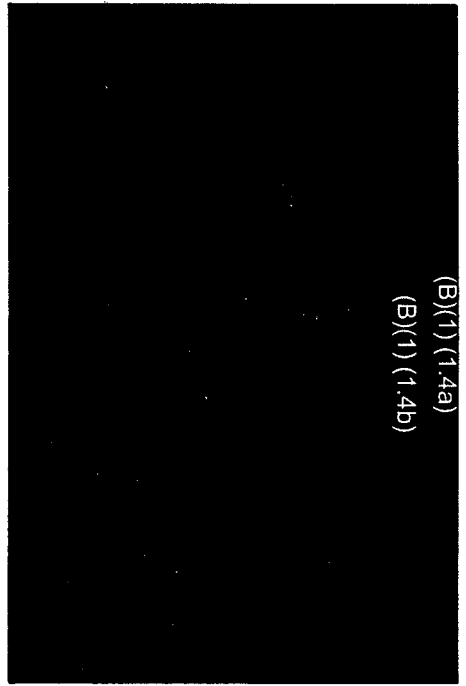
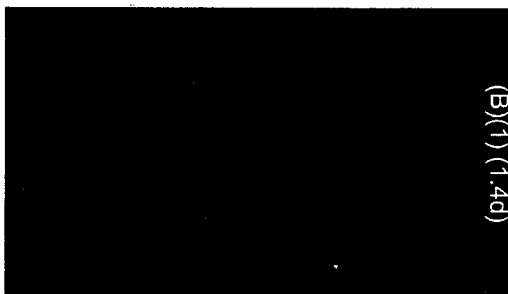

(B)(1) (1.4a)
 (B)(1) (1.4b)

(B)(1) (1.4d)

SECRET
 470

SECRET

Classified by: US Pacific Command Digest(S/NF). Source marked OADR, dtd 15 Feb 1995.

LAOS (U)

(U) BASIC INFORMATION

LAND AREA 238,804 Sq Km
NATIONAL OCEAN CLAIMS N/A (landlocked)
POPULATION 4.4 Million
ANNUAL GROWTH 2.9 Percent
RELIGION 85% Buddhist, 15% Animist and Other
GROSS DOMESTIC PRODUCT \$ 5 Billion
PER CAPITA \$ 230
INFLATION 9.8 Percent
DEFENSE BUDGET 3.8 Percent
TYPE GOVERNMENT Lao People's Democratic Republic,
Communist

PRESIDENT, CHAIRMAN OF THE SUPREME
PEOPLE'S ASSEMBLY NOUHAK Phoumsavan
PRIME MINISTER, CHAIRMAN OF THE CENTRAL
PARTY EXECUTIVE COMMITTEE KHAMTAI Siphandon
DEPUTY PRIME MINISTER KHAMPHOUJ Keobouasaphan
MINISTER OF FOREIGN AFFAIRS SOMSAVAT Lengsavat
LPA CHIEF OF STAFF LT GEN Ai Soulingseang

(U) U.S. KEY STAFF PERSONNEL

AMBASSADOR Victor TOMSETH
DEPUTY CHIEF OF MISSION Alan BARR
JOINT TASK FORCE-FULL ACCOUNTING/
DET 3 LTC Mike KENDALL, USA

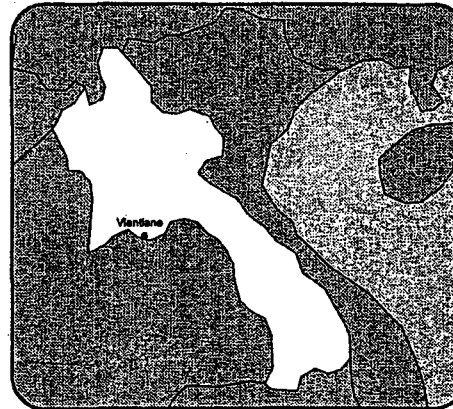

(B)(1) (1.4a)
(B)(1) (1.4b)

(B)(1) (1.4d)

SECRET
471

SECRET

Classified by: US Pacific Command Digest(S/NF). Source marked OADR, dtd 15 Feb 1995.

MADAGASCAR (U)

(U) BASIC INFORMATION

LAND AREA 587,040 Sq Km
NATIONAL OCEAN CLAIMS:
ECONOMIC ZONE 200 Nautical Miles
FISHING ZONE 150 Nautical Miles
TERRITORIAL SEA 12 Nautical Miles
Straight baselines claimed
POPULATION 13,427,758
ANNUAL GROWTH 3.2 Percent
LITERACY RATE 80 Percent
LIFE EXPECTANCY 52 Years
GROSS DOMESTIC PRODUCT (1993 Est) \$ 10.4 Billion
PER CAPITA \$ 200
DEFENSE BUDGET (1989 Est) \$ 37 Million
OF TOTAL GROSS DOMESTIC BUDGET 2.2 Percent
TYPE GOVERNMENT Democratic Republic
PRESIDENT Albert ZAFY
PRIME MINISTER Francisque RAVONY
MINISTER OF DEFENSE Francisque RAVONY
FOREIGN MINISTER Jacques SYLLA

* The United States does not recognize territorial sea claims in excess of 12 nautical miles or claimed security zones beyond the limits of the territorial sea.

(U) U.S. KEY STAFF PERSONNEL

AMBASSADOR Hon. Dennis P. BARRETT

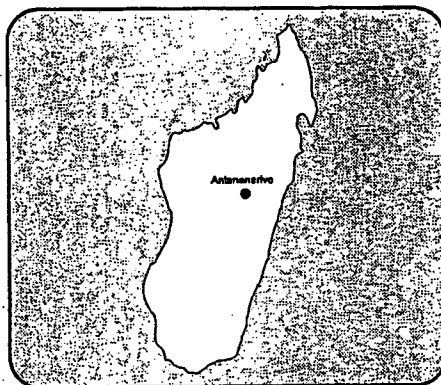

(B)(1) (1.4d)

(B)(1) (1.4a)
(B)(1) (1.4b)

~~SECRET~~

SECRET
472

Classified by: US Pacific Command Digest(S/NF). Source marked OADR, dtd 15 Feb 1995.

MALAYSIA (U)

(U) BASIC INFORMATION

LAND AREA 329,750 Sq Km
NATIONAL OCEAN CLAIMS:
ECONOMIC ZONE 200 Nautical Miles
FISHING ZONE 200 Nautical Miles
SECURITY ZONE None Claimed
TERRITORIAL SEA 12 Nautical Miles
POPULATION 19,010,000
ANNUAL GROWTH 2.4 Percent
LITERACY RATE 78 Percent
LIFE EXPECTANCY 68 Years
GROSS DOMESTIC PRODUCT \$ 80 Billion
PER CAPITA \$ 2,900
DEFENSE BUDGET \$ 2.4 Billion
OF TOTAL GOVERNMENT BUDGET 6.0 Percent
TYPE GOVERNMENT Constitutional Monarchy headed by
Paramount Ruler (King); government conducted
by a Prime Minister and bicameral parliament
(British Commonwealth)

PARAMOUNT RULER

..... King Tuanku Ja'Alar Ibn AL-MARMUM Tuanku Abdul Rahman

PRIME MINISTER Dato Seri Dr. MAHATHIR bin Mohamed

MINISTER OF FOREIGN AFFAIRS

..... Dato' ABDULLAH Bin Haji Ahmad Badawi

MINISTER FOR DEFENSE

..... Datuk Seri Haji Mohamed NAJIB bin Tun Haji Abdul Razak

CHIEF OF THE DEFENSE

FORCE GEN Dato BORHAN bin Haji Ahmad

CHIEF OF ARMY GEN Dato' ISMAIL bin Omar

CHIEF OF NAVY VADM Dato' Mohamed SHARIFF bin Isahak

CHIEF OF AIR FORCE

..... LTG Datuk Abdul GHANI bin Tan Sri Abdul Aziz

(U) U.S. KEY STAFF PERSONNEL

AMBASSADOR Hon. John S. WOLF

DATT COL Michael A. McDERMOTT, USA

SAO LTC Russell P. THURBER, USA

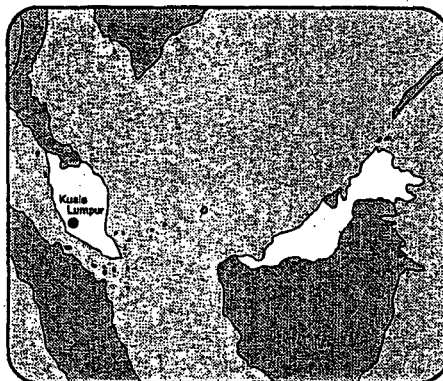

(U) U.S. GOALS AND OBJECTIVES

Maintain active role in the Five Power Defense Arrangement and ASEAN. Allow U.S. access to Malaysian training and maintenance facilities. Maintain combined ground, sea, and air exercise schedules. Secure access to air space and territorial waters.

(B)(1) (1.4a)

(B)(1) (1.4b)

CONFIDENTIAL
473

CONFIDENTIAL

Classified by: US Pacific Command Digest(S/NF). Source marked OADR, dtd 15 Feb 1995.

MALDIVES (U)

(U) BASIC INFORMATION

LAND AREA 300 Sq Km
NATIONAL OCEAN CLAIMS*
ECONOMIC ZONE Unique rectangular zone
encompassing 780,000 Sq Km
FISHING ZONE Unique rectangular zone
encompassing 780,000 Sq Km
SECURITY ZONE None Claimed
TERRITORIAL SEA 12 Nautical Miles
POPULATION 234,371
ANNUAL GROWTH 3.7 Percent
LITERACY RATE 92 Percent
LIFE EXPECTANCY 83 Years
GROSS DOMESTIC PRODUCT (1988) \$ 174 Million
PER CAPITA \$ 770
DEFENSE BUDGET \$ 1.8 Million
OF TOTAL GOVERNMENT BUDGET 3.8 Percent
TYPE GOVERNMENT Republic
(British Commonwealth)

PRESIDENT Maumoon Abdul GAYOOM
MINISTER OF DEFENSE Maumoon Abdul GAYOOM
MINISTER OF FOREIGN AFFAIRS Fathila JAMEEL
MINISTER OF TRADE AND INDUSTRIES Ihmed MUJUTHASA

* The United States does not recognize the claimed requirement to obtain prior permission for warship transit through the claimed territorial sea.

(U) U.S. KEY STAFF PERSONNEL

AMBASSADOR* Hon. Tereisa C. SCHAFFER
USCINCPACREP SRI LANKA/MALDIVES
and DATT* LTC Carl COCKRUM, USA

* Resides in Colombo, Sri Lanka.

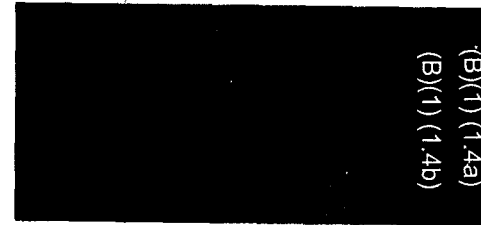
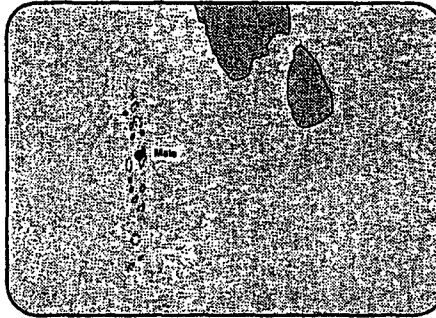

(B)(1) (1.4a)
(B)(1) (1.4b)



(B)(1)
(1.4d)

~~SECRET~~
A74

SECRET

Classified by: US Pacific Command Digest(S/NF). Source marked OADR, dtd 15 Feb 1995.

MARSHALL ISLANDS (U)

(U) BASIC INFORMATION

LAND AREA 181 Sq Km
NATIONAL OCEAN CLAIMS:
ECONOMIC ZONE 200 Nautical Miles
FISHING ZONE 200 Nautical Miles
SECURITY ZONE None Claimed
TERRITORIAL SEA 12 Nautical Miles
POPULATION 60,000
ANNUAL GROWTH 4.0 Percent
LITERACY RATE 93 Percent
LIFE EXPECTANCY 61 yrs. (male), 64 yrs. (female)
GROSS DOMESTIC PRODUCT \$ 63 Million
PER CAPITA \$ 1,500
DEFENSE BUDGET Not Applicable
OF TOTAL GOVERNMENT BUDGET Not Applicable
TYPE GOVERNMENT Sovereign, self-governing Republic
PRESIDENT Amata KABUA
MINISTER OF FOREIGN AFFAIRS Philip MULLER

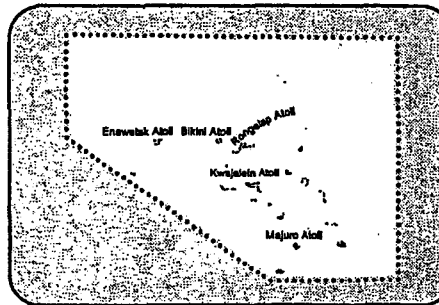

(U) MAJOR COUNTRY FORCES AND COMBAT CAPABILITY

Defense provided by the United States under the Compact of Free Association.

(U) U.S. KEY STAFF PERSONNEL

U.S. AMBASSADOR Hon. David C. FIELDS
USCINCPACREP RMI/COMMANDER,
U.S. ARMY KWAJALEIN ATOLL COL David E. SPAULDING, USA

(B)(1) (1,4d)

CONFIDENTIAL

475

CONFIDENTIAL

Classified by: US Pacific Command Digest(S/NF). Source marked OADR, dtd 15 Feb 1995.

MAURITIUS (U)

(C) BASIC INFORMATION

(U) LAND AREA 1,860 Sq Km
(U) NATIONAL OCEAN CLAIMS:^a
ECONOMIC ZONE 200 Nautical Miles
FISHING ZONE 200 Nautical Miles
TERRITORIAL SEA 12 Nautical Miles
Straight baselines claimed
(U) POPULATION 1,116,923
ANNUAL GROWTH 0.8 Percent
LITERACY RATE 82.8 Percent
LIFE EXPECTANCY 69 Years
(U) GROSS DOMESTIC PRODUCT \$ 8.6 Billion
PER CAPITA \$ 2,300
(C) DEFENSE BUDGET (FY 1987) \$ 5.0 Million
OF TOTAL GROSS DOMESTIC BUDGET 0.2 Percent
(U) TYPE GOVERNMENT Parliamentary Democracy
(British Commonwealth)

(U) PRESIDENT Cassim UTEEM
(U) PRIME MINISTER AND MINISTER
OF DEFENSE Anerood JUGNAUTH
(U) MINISTER OF EXTERNAL AFFAIRS Ahmad Swaley KASENALLY
(U) NATIONAL SECURITY ADVISOR
(Deputed Indian Officer) LTG Jagdish TAIMNI
(U) COMMISSIONER OF POLICE Cyril MORVAN
(U) COMMANDER, COAST GUARD
(Deputed Indian Officer) CDR Rajiv SEHGAL
(U) COMMANDER, SPECIAL MOBILE FORCES COL Raj DAYAL

^a The United States does not recognize the claimed requirement for advance notification for warship transit through the claimed territorial sea.

(U) U.S. KEY STAFF PERSONNEL

(U) AMBASSADOR Hon. Leslie ALEXANDER

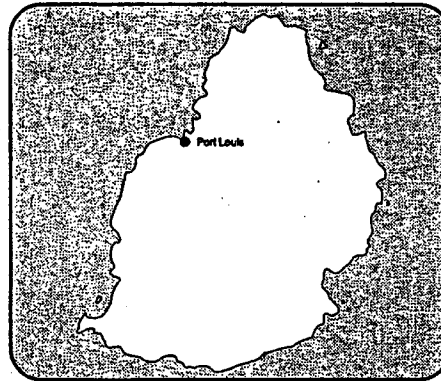

(B)(1) (1.4a)
(B)(1) (1.4b)



(B)(1) (1.4d)

~~SECRET~~
476

~~SECRET~~

Classified by: US Pacific Command Digest(S/NF). Source marked OADR, dtd 15 Feb 1995.

FEDERATED STATES OF MICRONESIA (U)

(U) BASIC INFORMATION

LAND AREA 702 Sq Km
 NATIONAL OCEAN CLAIMS:
 ECONOMIC ZONE 200 Nautical Miles
 FISHING ZONE 200 Nautical Miles
 SECURITY ZONE None Claimed
 TERRITORIAL SEA 12 Nautical Miles
 POPULATION 114,700
 ANNUAL GROWTH 3.4 Percent
 LITERACY RATE 90 Percent
 LIFE EXPECTANCY 65 yrs. (male), 68 yrs. (female)
 GROSS NATIONAL PRODUCT \$ 150 million
 PER CAPITA \$ 1,500
 DEFENSE BUDGET Not Applicable
 OF TOTAL GOVERNMENT BUDGET Not Applicable
 TYPE GOVERNMENT Sovereign, self-governing Federation
 PRESIDENT Balley OLTER
 SECRETARY OF EXTERNAL AFFAIRS Resio MOSES

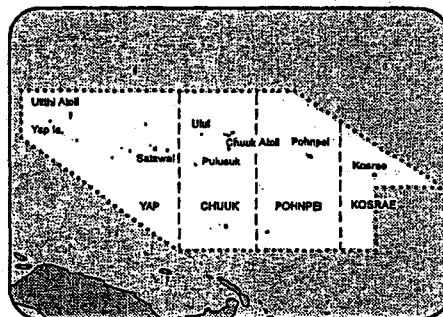

(U) MAJOR COUNTRY FORCES AND COMBAT CAPABILITY

Defense provided by the United States under the Compact of Free Association.

(U) U.S. KEY STAFF PERSONNEL

AMBASSADOR Hon. March FONG EU
 USCINCPACREP GUAM/CNM/FSM/
 PALAU* RADM David L. BREWER III, USN

* Resides in Guam.

(B)(1) (1.4d)

CONFIDENTIAL
477

CONFIDENTIAL

MONGOLIA (U)

(U) BASIC INFORMATION

LAND AREA 1,565,000 Sq Km
NATIONAL OCEAN CLAIMS: Land-locked Country
POPULATION 2,429,762
ANNUAL GROWTH 2.7 Percent
LITERACY RATE 90 Percent
LIFE EXPECTANCY 63 Years
GROSS DOMESTIC PRODUCT \$ 2.8 Billion
PER CAPITA \$ 1,200
DEFENSE BUDGET \$ 22.8 Million
OF TOTAL GOVERNMENT BUDGET 1 percent
TYPE GOVERNMENT Transition from Communist State to Republic

PRESIDENT Punsalmaagyn OCHIRBAT
PRIME MINISTER Puntsaglyn JASRAY
MINISTER OF DEFENSE LTG Shagalyin JADAMBAA
CHIEF OF DEFENSE FORCES MG Raatmaaglyn GAVAA

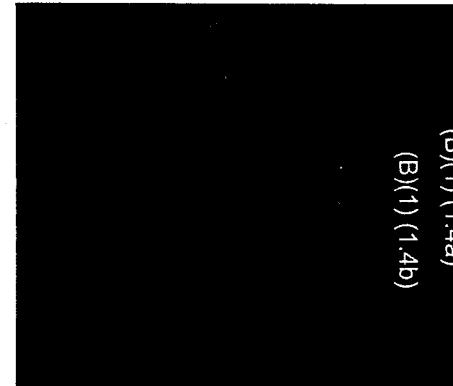
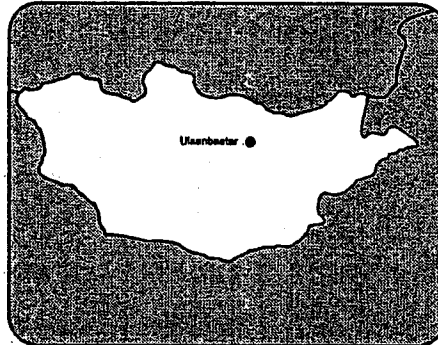

(B)(1) (1.4a)
(B)(1) (1.4b)

(U) U.S. KEY STAFF PERSONNEL

AMBASSADOR Hon. Donald JOHNSON
DATT* Col Donald ROLAND, USAF

* Resides in Beijing, China, where he is Air Attache to China.



(B)(1) (1.4d)

~~SECRET~~
478

~~SECRET~~

Classified by: US Pacific Command Digest(S/NF). Source marked OADR, dtd 15 Feb 1995.

NEPAL (U)

(U) BASIC INFORMATION

LAND AREA 140,800 Sq Km
NATIONAL OCEAN CLAIMS: Land-locked Country
POPULATION 21,041,527
ANNUAL GROWTH 2.4 Percent
LITERACY RATE 26 Percent
LIFE EXPECTANCY 51 Years
GROSS DOMESTIC PRODUCT \$20.5 Billion
PER CAPITA \$ 165
DEFENSE BUDGET \$ 34 Million
OF TOTAL GROSS DOMESTIC BUDGET 2 Percent
TYPE GOVERNMENT Constitutional Monarchy

KING AND CINC BIRENDRA Bir Bikram Shah Dev
PRIME MINISTER, MINISTER OF DEFENSE,
AND MINISTER OF FOREIGN AFFAIRS Girija Prasad KOIRALA
CHIEF OF ARMY STAFF GEN Gabul Shumshere Jang Bahadur RANA

(U) U.S. KEY STAFF PERSONNEL

AMBASSADOR Hon. Sandra L. VOGELGESANG
DATT* LTC Jamez A. DUNN, Jr., USA

* Resides in Dhaka, Bangladesh.

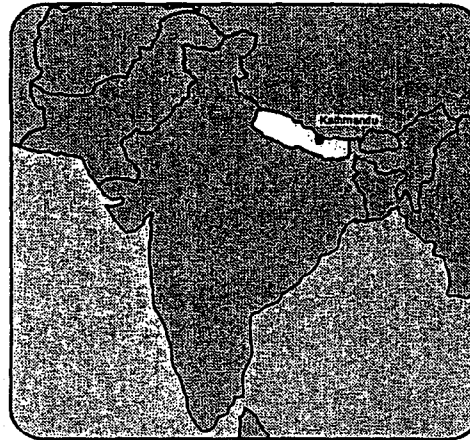

(B)(1) (1.4a)
(B)(1) (1.4b)



(B)(1)
(1.4d)

SECRET
479

SECRET

Classified by: US Pacific Command Digest(S/NF). Source marked OADR, dtd 15 Feb 1995.

NEW ZEALAND (U)

(U) BASIC INFORMATION

LAND AREA 266,670 Sq Km
NATIONAL OCEAN CLAIMS:
ECONOMIC ZONE 200 Nautical Miles
FISHING ZONE 200 Nautical Miles
SECURITY ZONE None Claimed
TERRITORIAL SEA 12 Nautical Miles
POPULATION 3,247,000
ANNUAL GROWTH 0.7 Percent
LITERACY RATE 99 Percent
LIFE EXPECTANCY 72 yrs. (male), 80 yrs. (female)
GROSS DOMESTIC PRODUCT \$ 53 Billion
PER CAPITA \$ 15,700
DEFENSE BUDGET \$ 694 Million
OF TOTAL GOVERNMENT BUDGET 4.5 Percent
TYPE GOVERNMENT Independent Parliamentary Democracy
within the Commonwealth recognizing Queen Elizabeth II
as Sovereign or Head of State

GOVERNOR GENERAL Dame Catherine TIZARD
PRIME MINISTER Jim BOLGER
FOREIGN AFFAIRS MINISTER Don McKINNON
MINISTER OF DEFENCE Warren COOPER
CHIEF OF DEFENCE STAFF VADM Somerford TEAGLE
CHIEF OF THE GENERAL STAFF,
ARMY MG Anthony L. BIRKS
CHIEF OF NAVAL STAFF RADM John E. N. WELSH
CHIEF OF AIR STAFF AVM John S. HOSIE

(U) U.S. KEY STAFF PERSONNEL

AMBASSADOR Hon. Joseph H. BEEMAN
DATT CAPT Richard L. NORWOOD, USN

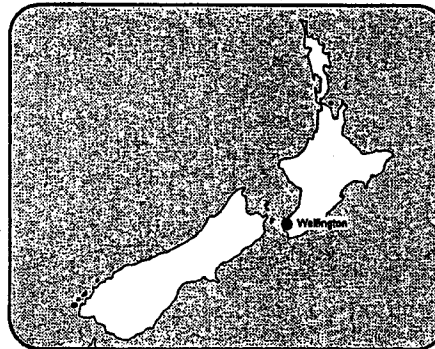

(B)(1) (1.4a)
(B)(1) (1.4b)

(B)(1) (1.4d)

~~SECRET~~
480

~~SECRET~~

Classified by: US Pacific Command Digest(S/NF). Source marked OADR, dtd 15 Feb 1995.

PAPUA NEW GUINEA (U)

(U) BASIC INFORMATION

LAND AREA	451,710 Sq Km
NATIONAL OCEAN CLAIMS:	
ECONOMIC ZONE	200 Nautical Miles
FISHING ZONE	200 Nautical Miles
SECURITY ZONE	None Claimed
TERRITORIAL SEA	12 Nautical Miles
POPULATION	4,006,500
ANNUAL GROWTH	2.3 Percent
LITERACY RATE	52 Percent
LIFE EXPECTANCY	55 yrs. (male), 58 yrs. (female)
GROSS DOMESTIC PRODUCT	\$ 3.1 Billion
PER CAPITA	\$ 800
DEFENSE BUDGET	\$ 42 Million
OF TOTAL GOVERNMENT BUDGET	2.9 Percent
TYPE GOVERNMENT	Parliamentary State within the Commonwealth, recognizing Queen Elizabeth II as Head of State
GOVERNOR GENERAL Sir Wiwa KOROWI	
PRIME MINISTER Sir Julius CHAN	
MINISTER OF FOREIGN AFFAIRS Sir Julius CHAN	
DEFENSE MINISTER Paul TOHIAN	
COMMANDER PNG DEFENSE FORCE BG Anthony HUIAI	

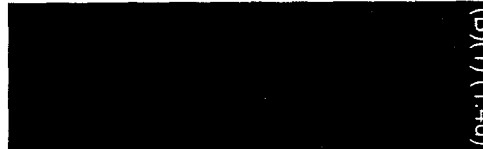
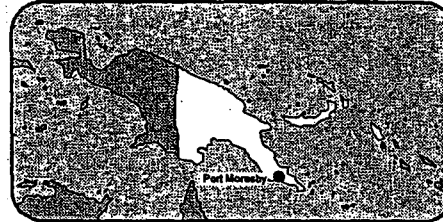

(B)(1) (1.4d)

(B)(1) (1.4a)
(B)(1) (1.4b)

(U) U.S. KEY STAFF PERSONNEL

AMBASSADOR	Hon. Richard W. TEARE
DATT*	COL Shelby STEVENS, USA

* Resides in Canberra, Australia.

SECRET
481

SECRET

Classified by: US Pacific Command Digest(S/NF). Source marked OADR, dtd 15 Feb 1995.

PHILIPPINES (U)

(U) BASIC INFORMATION

LAND AREA 298,170 Sq Km
 NATIONAL OCEAN CLAIMS:
 ECONOMIC ZONE 200 Nautical Miles
 FISHING ZONE 200 Nautical Miles
 SECURITY ZONE None Claimed
 TERRITORIAL SEA 0.5 to 285 Nautical Miles
 POPULATION 86,117,284
 ANNUAL GROWTH 2.4 Percent
 LITERACY RATE 90 Percent
 LIFE EXPECTANCY 66 Years
 GROSS NATIONAL PRODUCT \$ 45.2 Billion
 PER CAPITA \$ 700
 DEFENSE BUDGET \$ 1.1 Billion
 OF TOTAL GOVERNMENT BUDGET 15.3 Percent
 TYPE GOVERNMENT Republic

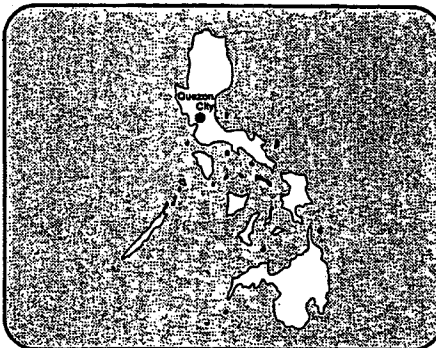

PRESIDENT Fidel V. RAMOS
 VICE PRESIDENT Joseph "Erap" ESTRADA
 SECRETARY OF FOREIGN AFFAIRS Roberto ROMULO
 SECRETARY OF NATIONAL DEFENSE Renato DE VILLA
 CHIEF OF STAFF, AFP GEN Arturo T. ENRILE
 CG, ARMY LTG Romulo YAP
 FDIC, NAVY COMMO Pio P. CARRANZA
 CG, AIR FORCE MG Nicolas P. RODRIGUEZ
 CHIEF, NATIONAL POLICE Ricardo A. SARMIENTO II

* The United States does not recognize the Philippines' claim of archipelagic status. The maritime claims of the Philippines are based in part upon geographic coordinates in the 1898 Treaty of Paris and the 1930 US-UK Treaty delimiting the boundary with Somal.

(U) U.S. KEY STAFF PERSONNEL

AMBASSADOR Hon. John D. NEGROPONTE
 USCINCPACREP PHIL COL Wayne M. BARTH, USA
 CHIEF JUSMAGPHIL COL Wayne M. BARTH, USA
 DATT Col James E. WILLIAMS, USAF

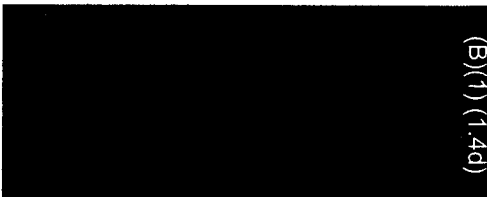

(B)(1) (1.4d)

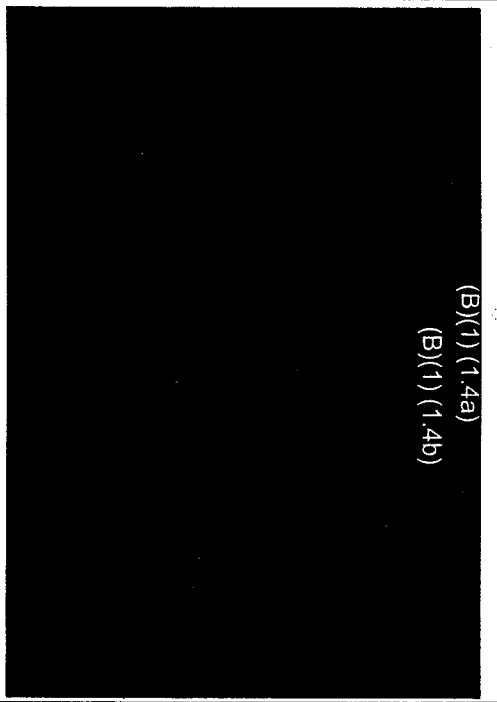

(B)(1) (1.4a)
 (B)(1) (1.4b)

SECRET
 482

SECRET

Classified by: US Pacific Command Digest(S/NF). Source marked OADR, dtd 15 Feb 1995.

SEYCHELLES (U)

(U) BASIC INFORMATION

LAND AREA 455 Sq Km
NATIONAL OCEAN CLAIMS:*
ECONOMIC ZONE 200 Nautical Miles
FISHING ZONE 200 Nautical Miles
SECURITY ZONE None Claimed
TERRITORIAL SEA 12 Nautical Miles
POPULATION 69,519
ANNUAL GROWTH 0.9 Percent
LITERACY RATE 85 Percent
LIFE EXPECTANCY 70 Years
GROSS DOMESTIC PRODUCT (1989) \$ 350 Million
PER CAPITA \$ 4,100
DEFENSE BUDGET (1990 Est.) \$ 12 Million
OF TOTAL GROSS DOMESTIC BUDGET 8.0 Percent
TYPE GOVERNMENT Republic
(British Commonwealth)

PRESIDENT France Albert RENE
MINISTER OF DEFENSE COL James MICHEL
COMMANDER, NAVAL FORCES COMO Leonard LABIACHE
MINISTER OF FOREIGN AFFAIRS Daniel DE ST. JORRE

* The United States does not recognize the claimed requirement for advance notification for warship transit through the claimed territorial sea.

(U) U.S. KEY STAFF PERSONNEL

AMBASSADOR Hon. Carl STOKES

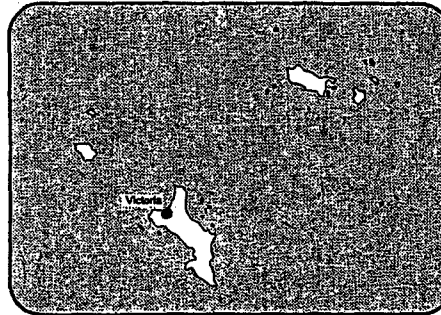

(B)(1) (1.4d)

(B)(1) (1.4a)
(B)(1) (1.4b)

483
~~SECRET~~

~~SECRET~~

Classified by: US Pacific Command Digest(S/NF). Source marked OADR, dtd 15 Feb 1995.

SINGAPORE (U)

(U) BASIC INFORMATION

LAND AREA 632.6 Sq Km
NATIONAL OCEAN CLAIMS:
ECONOMIC ZONE Agreed Boundaries
FISHING ZONE 12 Nautical Miles
SECURITY ZONE None Claimed
TERRITORIAL SEA 3 Nautical Miles
POPULATION 2,756,330
ANNUAL GROWTH 1.3 Percent
LITERACY RATE 88 Percent
LIFE EXPECTANCY 74 Years
GROSS DOMESTIC PRODUCT \$ 38.3 Billion
PER CAPITA \$ 13,900
DEFENSE BUDGET \$ 1.7 Billion
OF TOTAL GROSS DOMESTIC PRODUCT 4 Percent
TYPE GOVERNMENT Republic within Commonwealth

PRESIDENT ONG Teng Cheong
PRIME MINISTER GOH Chok Tong
MINISTER OF FOREIGN AFFAIRS WONG Kan Seng
MINISTER OF DEFENCE LEE Boon Yang
CHIEF OF DEFENCE FORCE LTG NG Jui Ping
CHIEF OF ARMY MG LIM Neo Chien
CHIEF OF NAVY RADM Willie KWEK Siew Jin
CHIEF OF AIR FORCE Maj Gen BEY Soo Khlang

(U) U.S. KEY STAFF PERSONNEL

AMBASSADOR Hon. Timothy A. CHORBA
DATT CAPT Jeremy C. ROSENBERG, USN
CHIEF, SAO Lt Col Dennis B. FOWLER, USAF

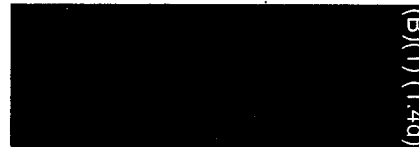
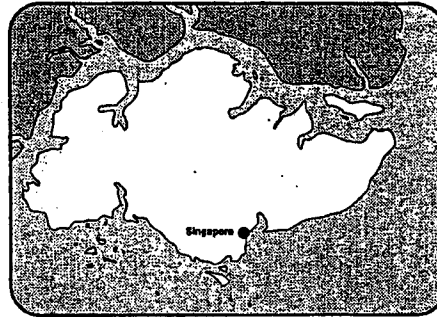

(B)(1) (1.4d)

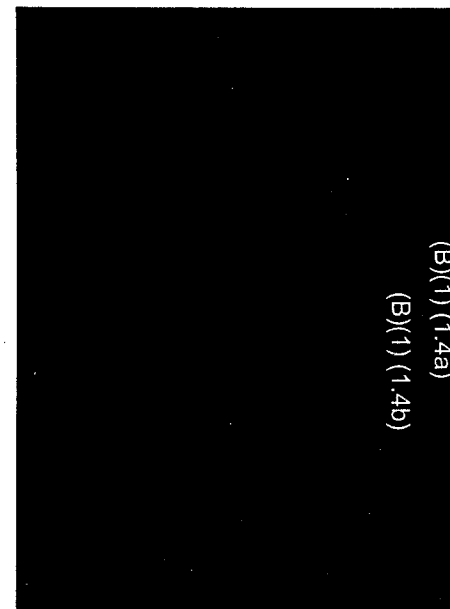

(B)(1) (1.4a)
(B)(1) (1.4b)

~~SECRET~~

Classified by: US Pacific Command Digest(S/NF). Source marked OADR, dtd 15 Feb 1995.

484
~~SECRET~~

SOLOMON ISLANDS (U)

(U) BASIC INFORMATION

LAND AREA 27,540 Sq Km
NATIONAL OCEAN CLAIMS*
ECONOMIC ZONE 200 Nautical Miles
FISHING ZONE 200 Nautical Miles
SECURITY ZONE None Claimed
TERRITORIAL SEA 12 Nautical Miles
POPULATION 350,000
ANNUAL GROWTH 3.5 Percent
LITERACY RATE 60 Percent
LIFE EXPECTANCY 67 yrs. (male), 72 yrs. (female)
GROSS DOMESTIC PRODUCT \$ 200 million
PER CAPITA \$ 500
TYPE GOVERNMENT Parliamentary Democracy
within the Commonwealth

GOVERNOR GENERAL Sir George LEPPING
PRIME MINISTER Solomon MAMALONI
FOREIGN MINISTER Danny PHILIP

* The United States has not recognized Solomon Islands' claim to archipelagic status. The Solomon Islands has established five archipelagic baseline systems around five separate groups of islands. The maritime claims of the Solomon Islands are measured from geographic coordinates.

(U) U.S. KEY STAFF PERSONNEL

AMBASSADOR* Hon. Richard W. TEARE
DATT COL Shelby STEVENS, USA

* Resides in Canberra, Australia.

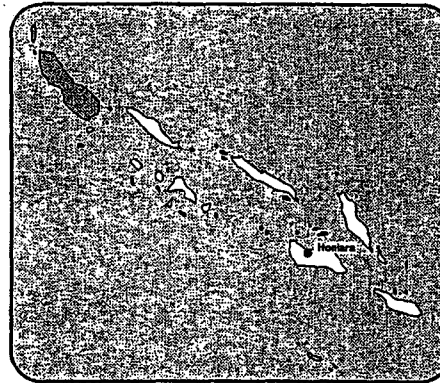

(B)(1)
(1.4d)

(B)(1)(1.4a)
(B)(1)(1.4b)

~~CONFIDENTIAL~~

~~CONFIDENTIAL~~

485

Classified by: US Pacific Command Digest(S/NF). Source marked OADR, dtd 15 Feb 1995.

SRI LANKA (U)

(U) BASIC INFORMATION

TOTAL AREA 85,610 Sq Km
LAND AREA 64,740 Sq Km
NATIONAL OCEAN CLAIMS:^{*}
ECONOMIC ZONE 200 Nautical Miles
FISHING ZONE 108 Nautical Miles
SECURITY ZONE 24 Nautical Miles
TERRITORIAL SEA 12 Nautical Miles
POPULATION 18,129,850
ANNUAL GROWTH 1.2 Percent
LITERACY RATE 86 Percent
LIFE EXPECTANCY 71 Years
GROSS DOMESTIC PRODUCT (1993 Est.) \$ 83.5 Billion
PER CAPITA \$ 380
DEFENSE BUDGET \$ 365 Million
OF TOTAL GROSS DOMESTIC PRODUCT 4.7 Percent
TYPE GOVERNMENT Republic
(British Commonwealth)

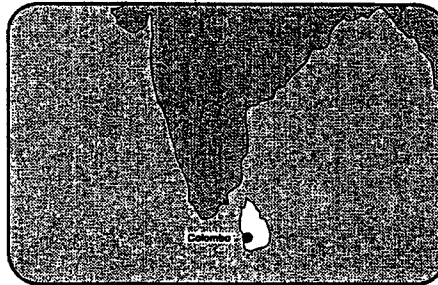

PRESIDENT, PRIME MINISTER, AND
MINISTER OF DEFENSE Chandrika Bandaranaike KUMARATUNGA
MINISTER OF FOREIGN AFFAIRS Lakshman KADIRGAMAR
ARMY COMMANDER Gerard DeSILVA
NAVY COMMANDER COMO Mohan SAMARASEKERA
AIR FORCE COMMANDER VAM Oliver RANASINGHE

^{*} The United States does not recognize the claimed requirement to obtain prior permission for warship transit through the claimed territorial sea.

(U) U.S. KEY STAFF PERSONNEL

AMBASSADOR Hon. Teresa C. SCHAFFER
USCINCPACREP and DATT SRI LANKA/
MALDIVES LTC Carl COCKRUM, USA



(B)(1) (1.4d)



(B)(1) (1.4a)
(B)(1) (1.4b)

SECRET
486

SECRET

Classified by: US Pacific Command Digest(S/NF). Source marked OADR, dtd 15 Feb 1995.

TAIWAN (U)

(U) BASIC INFORMATION

LAND AREA 35,981 Sq Km
 NATIONAL OCEAN CLAIMS:
 ECONOMIC ZONE 200 Nautical Miles
 FISHING ZONE 200 Nautical Miles
 SECURITY ZONE None Claimed
 TERRITORIAL SEA 12 Nautical Miles
 POPULATION 20,879,000
 ANNUAL GROWTH 1 Percent
 LITERACY RATE 91.2 Percent
 LIFE EXPECTANCY 72 Years
 GROSS DOMESTIC PRODUCT \$ 224 Billion
 PER CAPITA \$ 10,800
 DEFENSE BUDGET \$ 10.9 Billion
 OF TOTAL GOVERNMENT BUDGET 25 Percent
 TYPE GOVERNMENT Multi-Party Presidential Regime

PRESIDENT LEE Teng-hui
 PREMIER LIEN Chan
 MINISTER OF NATIONAL DEFENSE SUN Chen
 MINISTER OF FOREIGN AFFAIRS Frederick CHIEN
 CHIEF OF THE GENERAL STAFF ADM LIU Ho-chien
 COMMANDER IN CHIEF, ARMY GEN CHEN Ting-chung
 COMMANDER IN CHIEF, NAVY ADM CHUANG Ming-yao
 COMMANDER IN CHIEF, AIR FORCE GEN TANG Fai
 COMMANDER IN CHIEF, COMBINED
 SERVICE FORCE GEN-2d Grade LO Pee-li
 COMMANDANT OF THE MARINE CORPS LtGen CHENG Kuo-nan

Director, American Institute in Taiwan (AIT),
 (Taipei Office) Mr. B. Lynn PASCOE
 Chief, Technical Affairs Section
 (Security Assistance) Mr. Gus SORENSON

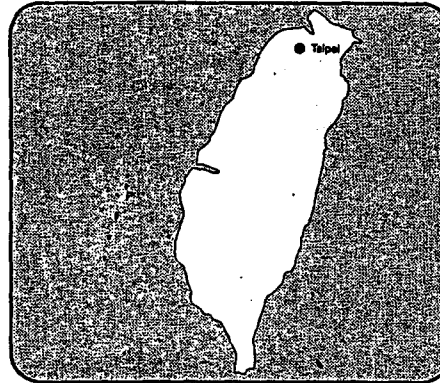

(B)(1) (1.4a)
 (B)(1) (1.4b)

(B)(1) (1.4d)

~~SECRET~~
 487

~~SECRET~~

Classified by: US Pacific Command Digest(S/NF). Source marked OADR, dtd 15 Feb 1995.

THAILAND (U)

(U) BASIC INFORMATION

LAND AREA 511,770 Sq Km
 NATIONAL OCEAN CLAIMS:
 ECONOMIC ZONE 200 Nautical Miles
 FISHING ZONE 200 Nautical Miles
 SECURITY ZONE None Claimed
 TERRITORIAL SEA 12 Nautical Miles
 Straight baselines claimed
 POPULATION 57,824,180
 ANNUAL GROWTH 1.4 Percent
 LITERACY RATE 93 Percent
 LIFE EXPECTANCY 68 Years
 GROSS NATIONAL PRODUCT \$ 79 Billion
 PER CAPITA \$ 1,505
 DEFENSE BUDGET \$ 2.7 Billion
 OF TOTAL GOVERNMENT BUDGET 3 Percent
 TYPE GOVERNMENT Constitutional Monarchy

 KING BHUMIBOL Adulyadej
 PRIME MINISTER CHUAN Likphai
 MINISTER OF DEFENSE VICHIT Sooknak
 MINISTER OF FOREIGN AFFAIRS PRASONG Soonsri
 SUPREME COMMANDER,
 ARMED FORCES GEN WATANACHAI Woolisri
 CINC ARMY GEN WIMOL Wongwanich
 CINC NAVY ADM PRACHET Sridet
 CINC AIR FORCE ACM SIRIPHONG Thongyal

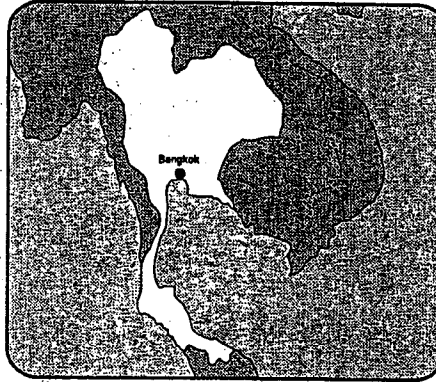

(U) U.S. KEY STAFF PERSONNEL

AMBASSADOR Hon. David F. LAMBERTSON
 USCINCPACREP and
 CHIEF JUSMAGTHAI COL Thomas A. SWINDELL, USA
 DATT Col Thomas J. BISHOP, USAF

(B)(1) (1.4d)

(B)(1) (1.4a)
 (B)(1) (1.4b)

488
~~SECRET~~

~~SECRET~~

Classified by: US Pacific Command Digest(S/NF). Source marked OADR, dtd 15 Feb 1995.

TONGA (U)

(U) BASIC INFORMATION

LAND AREA 718 Sq Km
NATIONAL OCEAN CLAIMS*
ECONOMIC ZONE 200 Nautical Miles
FISHING ZONE 200 Nautical Miles
SECURITY ZONE None Claimed
TERRITORIAL SEA 12 Nautical Miles
POPULATION 105,000
ANNUAL GROWTH 0.8 Percent
LITERACY RATE 95-100 Percent
LIFE EXPECTANCY 65 yrs. (male), 70 yrs. (female)
GROSS DOMESTIC PRODUCT \$ 200 Million
PER CAPITA \$ 2,000
TYPE GOVERNMENT Constitutional Monarchy
(British Commonwealth)

KING Tautua'ehu TUPOU IV
PRIME MINISTER Baron VAEA
MINISTER FOR FOREIGN AFFAIRS
AND DEFENSE Crown Prince TUPOUTO'A

* Tonga's maritime claims are based upon geographical coordinates established by Royal Proclamation. Internal waters are defined as the area between 173° to 177°W and 15° to 23°30'S.

(U) U.S. KEY STAFF PERSONNEL

CHARGE d'AFFAIRS* Bruce GRAY
USCINCPACREP FUJ and
DATT* LtCol Kip J. NAUGLE, USMC

* Resides in Suva, Fiji.

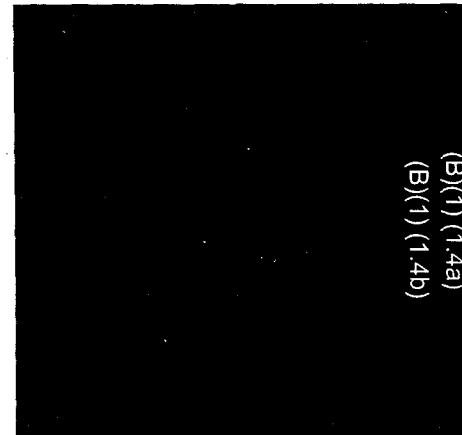
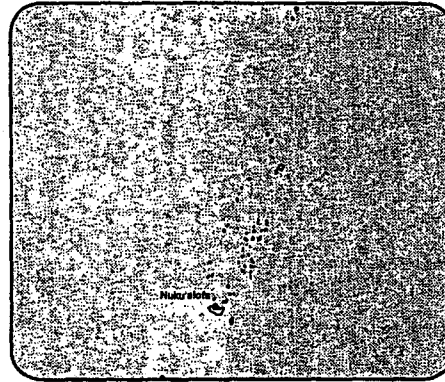

(B)(1) (1.4a)
(B)(1) (1.4b)

(B)(1)
(1.4d)

SECRET
489

SECRET

Classified by: US Pacific Command Digest(S/NF). Source marked OADR, dtd 15 Feb 1995.

VANUATU (U)

(U) BASIC INFORMATION

LAND AREA 14,780 Sq Km
NATIONAL OCEAN CLAIMS:
ECONOMIC ZONE 200 Nautical Miles
FISHING ZONE 200 Nautical Miles
SECURITY ZONE None Claimed
TERRITORIAL SEA 12 Nautical Miles
POPULATION 174,800
ANNUAL GROWTH 3.0 Percent
LITERACY RATE 53 Percent
LIFE EXPECTANCY 87 yrs. (male), 72 yrs. (female)
GROSS DOMESTIC PRODUCT \$ 142 million
PER CAPITA \$ 900
DEFENSE BUDGET Not Available
OF TOTAL GOVERNMENT BUDGET Not Available
TYPE GOVERNMENT Republic
(British Commonwealth)

PRESIDENT Fred TIMAKATA
PRIME MINISTER Maxima CARLOT
MINISTER OF FOREIGN AFFAIRS Maxima CARLOT

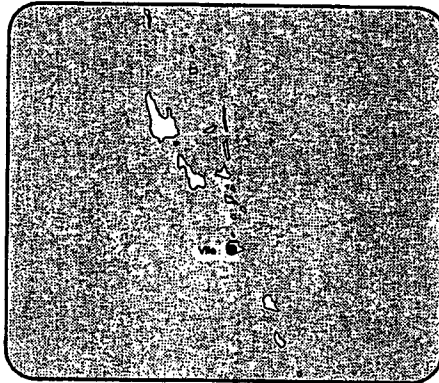

(U) U.S. KEY STAFF PERSONNEL

AMBASSADOR* Hon. Richard W. TEARE
DATT* COL Shelby STEVENS, USA

* Resides in Canberra, Australia.

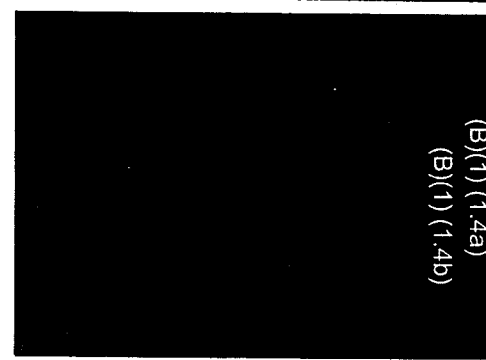

(B)(1) (1.4a)
(B)(1) (1.4b)



(B)(1) (1.4d)

CONFIDENTIAL

CONFIDENTIAL

490

Classified by: US Pacific Command Digest(S/NF). Source marked OADR, dtd 15 Feb 1995.

VIETNAM (U)

(U) BASIC INFORMATION

LAND AREA 325,360 Sq Km
 NATIONAL OCEAN CLAIMS:
 ECONOMIC ZONE 200 Nautical Miles
 FISHING ZONE 200 Nautical Miles
 SECURITY ZONE 24 Nautical Miles
 TERRITORIAL CLAIM 12 Nautical Miles
 DISPUTES Maritime boundary with Cambodia not defined;
 involved in a complex dispute over the Spratly Islands
 with China, Malaysia, Philippines, Taiwan, and possibly
 Brunei; unresolved maritime boundary with Thailand;
 maritime boundary dispute with China in the Gulf of
 Tonkin; Parcel Islands occupied by China but claimed
 by Vietnam and Taiwan.
 POPULATION 71,787,609
 ANNUAL GROWTH 2.2 Percent
 LITERACY RATE 88% (male 92%; female 84%)
 LIFE EXPECTANCY 63 yrs. (male), 67 yrs. (female)
 GROSS NATIONAL PRODUCT \$ 15 Billion
 PER CAPITA \$ 220
 TYPE GOVERNMENT Communist State,
 headed by President Le Duc Anh (four-star general)
 SECRETARY GENERAL OF THE
 COMMUNIST PARTY OF VIETNAM Do MUOI
 PRIME MINISTER Vo Van KIET
 MINISTER OF FOREIGN AFFAIRS Nguyen Manh CAM
 MINISTER OF NATIONAL DEFENSE General Doan KHUE
 COMMANDER IN CHIEF OF THE ARMED
 FORCES General Lee Duc ANH
 COMMANDER IN CHIEF, ARMY General Doan KHUE
 COMMANDER IN CHIEF, NAVY Vice Admiral Hoan Huu THAI
 COMMANDER IN CHIEF, AIR FORCE
 Lieutenant General Pham Tham NGAN

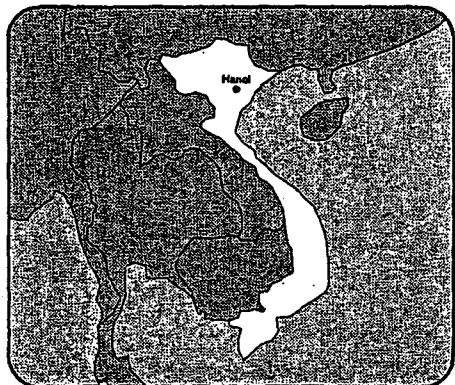

(B)(1) (1.4d)

(B)(1) (1.4a)
 (B)(1) (1.4b)

(U) U.S. KEY STAFF PERSONNEL

NONE

~~SECRET~~
491

~~SECRET~~

Classified by: US Pacific Command Digest(S/NF). Source marked OADR, dtd 15 Feb 1995.

WESTERN SAMOA (U)

(U) BASIC INFORMATION

LAND AREA 2,850 Sq Km
NATIONAL OCEAN CLAIMS:
ECONOMIC ZONE 200 Nautical Miles
TERRITORIAL SEA 12 Nautical Miles
POPULATION 204,447
ANNUAL GROWTH 2.38 Percent
LIFE EXPECTANCY 68 years
GROSS DOMESTIC PRODUCT \$ 400 million
PER CAPITA \$ 2,000
DEFENSE BUDGET Not Available
OF TOTAL GOVERNMENT BUDGET Not Available
TYPE GOVERNMENT Constitutional Monarchy

HEAD OF STATE Malietoa TANUMAFILI II
PRIME MINISTER To'fi'fi ALESANA
COMMISSIONER OF POLICE Tanielu GALUVAO

(U) U.S. KEY STAFF PERSONNEL

AMBASSADOR* Hon. Joseph BEEMAN
CHARGE D'AFFAIRES Robert YAMATE
ALUSNA/DATT* CAPT Richard L. NORWOOD, USN

* Resides in Wellington, New Zealand.

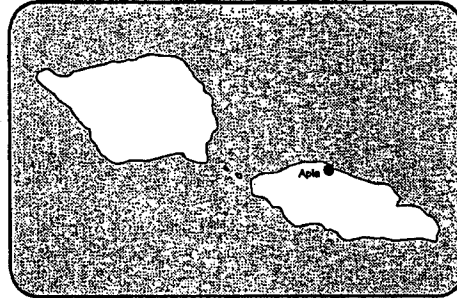

(B)(1) (1.4d)

(B)(1) (1.4a)
(B)(1) (1.4b)

~~CONFIDENTIAL~~

492

~~CONFIDENTIAL~~

Classified by: US Pacific Command Digest(S/NF). Source marked OADR, dtd 15 Feb 1995.

UNCLASSIFIED

GLOSSARY

A

A&T-----Administrative and Technical
AB-----Air Base
AC-----Companion of the Order of Australia
ACC-----Air Combat Command
ACIXS-----Allied Command Information and Exchange
 System
ACM-----Air Chief Marshal
ACSA-----Acquisition and Cross-Servicing
 Agreement
AdatP-11-----Allied Data Processing Publication-11
ADM-----Admiral
ADP-----Automatic Data Processing
AFB-----Air Force Base
AFOTEC-----Air Force Operational Test and
 Evaluation Center
AFP-----Armed Forces of the Philippines
AFTAC-----Air Force Technical Application Center
AID-----Agency for International Development
ALCE-----Airlift control element
AMC-----Air Mobility Command
AMHS-----Automated Message Handling System
AN/TSC-122-----HF Multichannel Communications Central
AO-----Area of operation; Order of Australia
AOR-----Area of Responsibility
APAS-----Alternate Performance Appraisal System
APS-----Afloat Prepositioning Ships
ARG-----Amphibious ready group
ART-----Archival Research Team
ASARS/EMTI-----Advanced Synthetic Aperture Radar/
 Enhanced Moving Target Indicator
ASD (RSA)-----Assistant SECDEF for Regional Security
 Affairs
ASEAN-----Association of Southeast Asian Nations
ASG-----Area Support Group
ASPJ-----Airborne Self Protection Jammer
AT-----Antiterrorism
ATO-----Air Tasking Order
AUSMIN-----Australian-United States Ministerial
AUTODIN-----Automatic Digital Network
AWM-----Australian War Memorial
AWR-----Army War Reserve

B

BITACG-----Bilateral Training and Consultative
 Group
BMAR-----Backlog of maintenance and repair
BOA-----Broad Ocean Areas
BRAC-----Base Realignment and Closure
BSL-3-----Biosafety Level 3 laboratory

UNCLASSIFIED

UNCLASSIFIED

BTO-----Brigade Tactical Officer
BUR-----Bottom Up Review

C

C&R-----Conversion and Redevelopment
C2I-----Command, Control, and Intelligence
C3-----Command and Control and Communications
C4-----Command, Control, Communications, and
Computers
C4I-----Command, Control, Communications, and
Computers, and Intelligence
CA-----Civil Affairs
CADS-----Containerized Ammunition Distribution
System
CAP-----Crisis Action Planning
CAPEX-----Capabilities Exercise
CASC-----Crisis Action Support Cell
CAT-----Crisis Action Team
CAX-----Computer aided exercise
CBS-----Corps Battle Simulation
CCEAP-----Command Center Emergency Action
Procedures
CCIB-----Command and Control Interoperability
Board
CD-----Counterdrug
CDF-----Chief of Defence Force, Australia
CDRUSAMRDC-----Commander, US Army Medical Research and
Development Command
CFC-----Combined Federal Campaign; Combined
Forces Command
CG-----COBRA GOLD; Commanding General
CG94-----Exercise COBRA GOLD '94
CHOP-----Change of operational control
CIF-----CINC Initiative Funds
CILHI-----US Army Central Identification
Laboratory, Hawaii
CINCCFC-----Commander in Chief, Combined Forces
Command
CINCPACFLT-----Commander in Chief, US Pacific Fleet
CINCUNC-----Commander in Chief, United Nations
Command
CIP-----Combined Interoperability Program
CIS-----Commonwealth of Independent States
CISS-----Combat Information Systems Squadron
CJCS-----Chairman Joint Chiefs of Staff
CJFA-----Commander Joint Forces Australia
CJTF-----Commander Joint Task Force
CJTF-FA-----Commander, Joint Task Force-Full
Accounting
CMAC-----Cambodian Mine Awareness Committee
CMO-----Civil-military operations; Collection
Management Office
CNA-----Center for Naval Analyses

UNCLASSIFIED

UNCLASSIFIED

CNO-----Chief of Naval Operations
COMALCOM-----Commander, Alaskan Command
COMINT-----Communications intelligence
COMMARFORPAC-----Commander, Marine Forces Pacific
COMNAVBASE-----Commander, Naval Base
COMNAVFORJAPAN-----Commander Naval Forces Japan
COMNAVFORKOR-----Commander Naval Forces Korea
COMNAVSURFPAC-----Commander, Naval Surface Force, US
Pacific Fleet
COMPUSEC-----Computer Security
COMSEC-----Communications Security
COMSOCPAC-----Commander, Special Operations Command
Pacific
COMTHIRDFLT-----Commander, THIRD Fleet
COMUSJAPAN-----Commander US Forces Japan
CONOPS-----Concept of operations
CONUS-----Continental United States
COSTIND-----Commission on Science, Technology, and
Industry for National Defense
CPV-----Chinese People's Volunteers
CPX-----Command post exercise
CRAF-----Civil Reserve Air Fleet
CS-----Communications Squadron
CSA-----Chief of Staff of the Army
CSPAR-----CINC's Preparedness Assessment Report
CT-----Counter terrorism
CTAPS-----Contingency Theater Automated Planning
System
CVBG-----Carrier battle group

D

D+45-----D-Day plus 45 days
DAMA-----Demand Assigned Multiple Access
DAO-----Defense Attaché Office
DASN(C&R)-----Deputy Assistant Secretary of the Navy
(Conversion and Redevelopment)
DATT-----Defense Attaché
DAV-----Disabled American Veteran
DCCEP-----Title 10, U.S.C., Section 2010,
Participation of Developing Countries
in Bilateral or Multilateral Military
Exercises (or Developing Countries
Combined Exercise Program)
DCINC-----Deputy Commander in Chief
DCM-----Deputy Chief of Mission
DEFSMAC-----Defense Special Missile and
Astronautics Center
Demil-----Demilitarization
DIA-----Defense Intelligence Agency
DISA PAC-----Defense Information Systems Agency,
Pacific
DISA-----Defense Information Systems Agency

UNCLASSIFIED

UNCLASSIFIED

DJTTFAC-----Deployable Joint Task Force
Augmentation Cell
DLA-----Defense Logistics Agency
DMZ-----Demilitarized Zone
DPMO-----Defense Prisoner of War/Missing in
Action Office
DPRK-----Democratic People's Republic of Korea
DRSN-----Defense Red Switch Network
DRU-----Direct reporting unit
DSA-----Defense Supply Advisor
DSAA-----Defense Security Assistance Agency
DSCS-----Defense Satellite Communications System
DSE-----Defence Scientific Establishment
DSNET-3-----Defense Secure Network 3
DTICC-----US-ROK Defense Technological and
Industrial Cooperation Committee
DTT-----Demining training team
DVA-----Department of Veterans Affairs

E

E-IMET-----Expanded IMET
E-mail-----Electronic Mail
EAM-----Emergency Action Message
EAS-----Equipment Afloat Ships
ECP-----Engineering Change Proposals
EDA-----Excess Defense Articles
EDSRA-----Extended docking selected restricted
availability
EEO-----Equal Employment Opportunity
EIS-----Environmental impact statement
ELCSS-----Electronic Collateral Support System
ELINT-----Electronic intelligence
EMTI-----Enhanced Moving Target Indicator
EOD-----Explosive ordnance disposal
EOT-----End-of-tour
EPA-----Environmental Protection Agency
EPP-----Emergency Power Plant
ER-----Electronic reconnaissance
ER/ESM-----Electronic reconnaissance and
electronic warfare support measures
ESC-----Executive Steering Committee
ESI-----Electrospace Systems Incorporated
ESM-----Electronic warfare support measures

F

FAB-----Foreign Affairs Bureau
FAP-----Family Advocacy Programs
FB94-----FREEDOM BANNER 94
FITCPAC-----Fleet Intelligence Training Center,
Pacific
FMF-----Foreign Military Financing
FMFPAC-----Fleet Marine Force Pacific

UNCLASSIFIED

UNCLASSIFIED

FMS-----Foreign Military Sales
FN-----Foreign nationals
FOB-----Forward operating base
FON-----Freedom of Navigation
FORSCOM-----Forces Command
FOSIF WPAC-----Fleet Ocean Surveillance Information
Facility, Western Pacific
FOUO-----For Official Use Only
FSC-----Family Service Center
FSS-----Fast Sealift Ship
FSSG-----Force Service Support Group
FTX-----Field training exercise
FY-----Fiscal Year
FYDP-----Five-Year Defense Program

G

GAO-----General Accounting Office
GCCS-----Global Command and Control System
GMF-----Ground Mobile Forces
GNFPP-----Global Naval Force Presence Policy
GOJ-----Government of Japan
GTE-HAWTEL-----GTE-Hawaiian Telephone

H

H/CA-----Humanitarian/Civic Assistance
HAC-----House Appropriations Committee
HAP-EP-----Humanitarian Assistance Program for
Excess Property
HF-----High Frequency
HICOM-----US Navy High Command HF Network
HistSum-----Historical Summary
HN-----Host-nation
HNFC-----Host Nation Funded Construction
HRA/SOLIC-----Humanitarian and Refugee Affairs and
Special Operations/ Low Intensity
Conflict Office
HTACC-----Hardened Tactical Air Control Center

I

I&W-----Indications and warning
IA-----Implementing Arrangement
IAEA-----International Atomic Energy Agency
IAF-----Indian Air Force
IAT-----Intelligence augmentation team
ID(L)-----Infantry Division (Light)
IDT-----Independent duty technician
IE-----Investigation Element
IE1-----Investigation Element One
IG-----Inspector general
IMB-----Interoperability Management Board

UNCLASSIFIED

UNCLASSIFIED

IMET-----International Military Education and Training
IMF-----International Monetary Fund
IMINT-----Imagery intelligence
INFOSEC-----Information Systems Security
INMARSAT-----International Maritime Satellite
Intelink-----Intelligence information server network
Intelink-S-----Secret-level intelligence information server network
IOC-----Initial operational capability
IRT-----Investigation and Recovery Team
ISA-----International Security Affairs
IST-----Intelligence support teams
ITO-----Integrated Tasking Order
ITV-----In-Transit Visibility
ITWAA-----Integrated Tactical Warning and Attack Assessment

J

J-Det-----Joint Intelligence Center, Pacific Detachment
JANAP 128-----Joint Army, Navy, Air Force Pacific Publication 128
JCMC-1-----Joint Crisis Management Capability-1
JCRC-----Joint Casualty Resolution Center
JCSE-----Joint Communications Support Element
JDA-----Japan Defense Agency
JDC-----Joint Documents Center
JDISS-----Joint Deployable Intelligence Support System
JECG-----Joint Exercise Control Group
JFA-----Joint Field Activity
JFACC-----Joint Force Air Component Command
JFMO-PAC-----Joint Frequency Management Office-Pacific
JIATF WEST-----Joint Interagency Task Force West
JICPAC-----Joint Intelligence Center Pacific
JITAP-----Joint Intelligence Training Activity, Pacific
JKMS-----Joint Key Management System
JLOTS-----Joint Logistics-Over-the-Shore
JLPC-----Joint Labor Policy Committee
JMAO-PAC-----Joint Mortuary Affairs Office-Pacific
JMET-----Joint Mission Essential Tasks
JMRR-----Joint Monthly Readiness Review (pronounced "Jammer")
JMTC-----Joint Military Technology Commission
JRD-----Japan Reconfiguration and Digitization
JSA-----Joint Security Area
JSCG-----Joint Service Color Guard
JSCP-----Joint Strategic Capabilities Plan
JSDF-----Japan Self-Defense Force
JSOTF-----Joint Special Operations Task Force

UNCLASSIFIED

UNCLASSIFIED

JSTARS-----Joint Surveillance Target Attack Radar
System
JTF-5-----Joint Task Force-5
JTF-FA-----Joint Task Force-Full Accounting
JTLS-----Joint Theater Level Simulation
JUSMAGPHIL-----Joint US Military Assistance Group,
Philippines
JUSMAGTHAI-----Joint US Military Advisory Group
Thailand
JWICS-----Joint Worldwide Intelligence
Communications System

K

Karsk-----A sheer rock face
KCCS-----Korean Combat Support System
KICC-----Kaho'olawe Island Conveyance Commission
KIRC-----Kaho'olawe Island Reserve Commission
Km-----Kilometers
KOC-----Kingdom of Cambodia
KT-----Kilotons
KWP-----Korean Workers' Party

L

LAN-----Local Area Network
LANTFLT-----Atlantic Fleet
LCC-----Logistics Cooperation Committee
LCS-----Labor Cost Sharing
LDMX-----Local Digital Message Exchange
LINKEX-----Linking exercise
LKA-----Last known alive
LOA-----Letter of Offer and Acceptance
LOGEX 37-----US-Thai Logistics Exercise 37
LPDR-----Lao People's Democratic Republic
LRC-----Logistics Response Cell; Logistics
Readiness Center
LRT-----US-Australian Logistics Review Talks
LSG-----Logistics Steering Group
LSI-----Live sighting investigation
LTG-----Lieutenant General
LWP-----Australia-US Logistics Working Party
LWR-----Light-water reactor
LZ-----Landing zone

M

MAC-----Military Armistice Commission
MACRS-----Missing Aircrew Reports
MAGTF-----Marine Air Ground Task Force
Manila Pact-----Southeast Asia Collective Defense
Treaty
MCAS-----Marine Corps Air Station

UNCLASSIFIED

UNCLASSIFIED

MCTSSA-----Marine Corps Tactical System Support
Activity
MDAO-----Mutual Defense Assistance Office
MDB-----Mutual Defense Board
MEA-----Ministry of External Affairs
MEDCAP-----Medical Civic Action Program or Project
MEF-----Marine Expeditionary Force
MFA-----Ministry of Foreign Affairs
MIA-----Missing-in-action
MIBN-----Military Intelligence Battalion
Mil-Mil-----Military-to-Military
MILDEPS-----Military Departments
MILREP-----Military Representative
MISSI-----Multilevel Information Systems Security
Initiative (NSA)
MLS-----Multi-Level Security
MMCP-----Mil-Mil Contact Program
MND-----Ministry of National Defense
MOA-----Memorandum of Agreement
MOD-----Ministry of Defense
MOP-----Memorandum of Policy
MOU-----Memorandum of Understanding
MPA-----Maritime patrol aircraft
MPS-----Maritime Prepositioning Squadron
MR-----Military Region
MRC-----Major Regional Contingency; Major
Regional Conflict
MRC-E-----Eastern Major Regional Contingency
MRC-W-----Western major regional contingency
MSC-----Military Sealift Command
Msg-----Message
MTCR-----Missile Technology Control Regime
MTF-----Message Text Format
MTI-----Moving Target Indicator
MWT-----Megawatt

N

NADK-----National Army of Democratic Kampuchea
NAMRU 2-----Naval Medical Research Unit Two
NAS-----Naval Air Station
NATO-----North American Treaty Organization
NAVSTA-----Naval Station
NCA-----National Command Authority
NCO-----Noncommissioned officer
NCTAMS EASTPAC-----Naval Computer Telecommunications Area
Master Station, Eastern Pacific
NEA-----Northeast Asia
NEO-----Noncombatant evacuation operation
NHO-----Naval Hospital Okinawa
NIST-----National Intelligence Support Team
NM-----Nautical miles
NMCC-----National Military Command Center

UNCLASSIFIED

UNCLASSIFIED

NMCP-----National Memorial Cemetery of the Pacific
NMS-----National Military Strategy
NORAD-----North American Aerospace Defense Command
NPT-----Nuclear Non-Proliferation Treaty
NSA-----National Security Agency
NSC-----National Security Council
NTCC-----Naval Telecommunications Center
NWS-----National Weather Service

O

OB/OD-----Open burning/open detonation
OCFHO-----Oahu Consolidated Family Housing Office
ODCR-----Operations Deputies Conference Room
OFRP-----Overseas Family Residency Program
OHA-----Office of Humanitarian Assistance;
 Office of Hawaiian Affairs
OHP-----Oral History Program
OIC-----Operational Intelligence Center
OP3-----Overt Peacetime Psychological
 Operations Program
OPDS-----Offshore Petroleum Discharge System
OPLAN-----Operations Plan
OPTEMPO-----Operational tempo
OSD-----Office of the Secretary of Defense
OSS-----Operations Support System
OTAR-----Over-the-Air Rekeying
OTAT-----Over-the-Air Transfer
OTCIXS-----Officer in Tactical Command Information
 Exchange System

P

PACAF-----Pacific Air Forces
PACALS-----Pacific Area Cooperative Acquisition
 and Logistics System
PACFLT-----Pacific Fleet
PACSAC-----Pacific Command Security Assistance
 Conference
PACVTC-----Pacific Video Teleconferencing Network
PARPRO-----Peacetime Aerial Reconnaissance Program
PARS-----Performance Appraisal Review System
PASOLS-----Pacific Area Senior Officer Logistics
 Seminar
PASS-----USPACOM ADP Server Sites
PAU-----Public Affairs Update
PAVN-----People's Army of Vietnam
PCIT-----Priority or Primary Case Investigation
 Team
PCS-----Pacific Command Strategy; Permanent
 change of station
PDC-----Project Development Committee

UNCLASSIFIED

UNCLASSIFIED

PDS-----Processing and Display Subsystem
PEG-----Performance Evaluation Group
PERSTEMPO-----Personnel tempo
PIB-----Pacific Intelligence Board
PKO-----Peacekeeping Operation
PLA-----People's Liberation Army
PM-----Prime Minister
PME-----Primary mission equipment; Professional
 Military Education
PMFP-----Preferred Munitions Forward Program
 (USCINCPAC)
PMO-----Program Management Office
PMRS-----Performance Management Review System
POC-----Point of contact
Pol-Mil-----Political-Military
POM-----Program Objectives Memoranda
POTS-----Plain Old Telephone System
POW-----Prisoner of war
POW/MIA-----Prisoner of war and missing-in-action
PRP-----Pilot Repair Program
PSCM-----Pacific Senior Communicators Meeting
PSYOP-----Psychological operations
PUC-----Public Utilities Commission
PY-----Program Year

Q

QOL-----Quality of Life
QRC-----Quick Reaction Checklist

R

R&D-----Research and Development
RAAF-----Royal Australian Air Force
RADM-----Rear Admiral
RAN-----Royal Australian Navy
RCAF-----Royal Cambodian Air Force; Royal
 Cambodian Armed Forces
RE-----Recovery element
REDTRAIN-----Readiness Training
Ret-----Retired
RNZ-----Royal New Zealand
Ro/Ro-----Roll-on/roll-off
ROK-----Republic of Korea
ROWPU-----Reverse osmosis water purification unit
RP-----Republic of the Philippines
RRA-----Reconnaissance reporting areas
RRF-----Ready Reserve Fleet
RSA-----Regional Security Affairs
RSO&I-----Reception, Staging, Onward Movement,
 and Integration
RTA-----Royal Thai Army
RTADS-----Royal Thai Air Defense System
RTAF-----Royal Thai Air Force

UNCLASSIFIED

UNCLASSIFIED

RTN-----Royal Thai Navy
RTSC-----Royal Thai Supreme Command
RTT-----Research task team
RUSIA-----Royal United Services Institute of
 Australia
RW-----Reconnaissance Wing

S

SA-----Security Assistance
SAAM-----Special Assignment Airlift Mission
SAD-----Seasonal Affective Disorder
SAO-----Security Assistance Organization;
 Security Assistance Office
SATPMR-----Security Assistance Training Program
 Management Review
SBMA-----Subic Bay Metropolitan Authority
SCC-----Security Consultative Committee
SCI-----Sensitive Compartmented Information
SCIS-----Survivable Communications Integration
 System
SCM-----Security Consultative Meeting
SEA-----Southeast Asia
SECDEF-----Secretary of Defense
SECNAV-----Secretary of the Navy
SECSTATE-----Secretary of State
SFOC-----Submarine fiber optic cable
SHF-----Super High Frequency
SIGINT-----Signals intelligence
SINGGARS-----Single Channel Ground Air Radio System
SITREP-----Situation report
SLAR-----Side Looking Airborne Radar
SLOC-----Sea lines of communication
SMA-----Special Measures Agreement
SME-----Subject matter experts
SMEB-----Significant Military Exercise Brief
SND-----Secretary of National Defense
 (Philippines)
SNS-----Secure Network Server
SO-----Special operations
SOC-----Special Operations Capable; State of
 Cambodia
SOC-K-----Special Operations Command-Korea
SOCPAC-----Special Operations Command, Pacific
SOJ-----Sea of Japan
SOLIC-----Special Operations/ Low Intensity
 Conflict Office
SOP-----Standard Operating Procedure
SORTS-----Status of Resources and Training System
SOS-----Special Operations Squadron
Speed battle-----Blitzkrieg type tactics used by DPRK
SPINTCOM-----Special Intelligence Communications
SRIG-----Surveillance, Reconnaissance,
 Intelligence Group

UNCLASSIFIED

UNCLASSIFIED

SRO-----Sensitive reconnaissance operations
SRT-----Special Remains Team
SRV-----Socialist Republic of Vietnam
STEL-----Standard Telecommunications
STEP-----Stripes for Exceptional Performer
STU-----Secure Telephone Unit
SWA-----Southwest Asia

T

T&E-----Test and evaluation
TACCIMS-----Tactical Army Command, Control and
Information Management System
TACSAT-----Tactical satellite
TAD-----Temporary attached duty
TADIL-----Tactical Automated Digital Information
Link
TAMC-----Tripler Army Medical Center
TAR-----Test and Acceptance Report; Tibetan
Autonomous Region
TB94-1-----Exercise TEMPO BRAVE '94-1
TCCS-----Theater Command and Control System
TDY-----Temporary duty
Telecon-----Telephone conversation
TFR-----Task Force RUSSIA
Title 10, Section 1051----Participation of Defense Personnel of
Developing Countries in Bilateral or
Regional Conferences, Seminars or
Similar Meetings (Personnel Expenses
Authority for Developing Countries)
Title 10, Section 401----Humanitarian/Civic Assistance (H/CA)
Provided in Conjunction with Military
Operations
Title 10-----Unified Commanders' Conduct of
Cooperative Programs with Friendly
Nations
TOR-----Terms of Reference
TPFDD-----Time-Phased Force and Deployment Data
TRADOC-----US Army Training and Doctrine Command
TSA-----Test support area
TSCIF-----Tactical sensitive compartmented
information facilities
TSP-----Test Support Positions
TT95-----Exercise TANDEM THRUST '95

U

U.S.C.-----US Code
UFL94-----Exercise ULCHI FOCUS LENS '94
UHF-----Ultra High Frequency
UK-----United Kingdom
UPS-----Uninterruptible Power Supply
USACOM-----US Atlantic Command
USARPAC-----US Army Pacific

UNCLASSIFIED

UNCLASSIFIED

USASOC-----US Army Special Operations Command
USCENTCOM-----US Central Command
USFK-----US Forces Korea
USIS-----United States Information Service
USLO-----US Liaison Office
USMTF-----US Message Text Format
USTRANSCOM-----US Transportation Command
UXO-----Unexploded ordnance

V

VC-----Viet Cong
VCJCS-----Vice Chairman, Joint Chiefs of Staff
VFW-----Veterans of Foreign Wars
VHF-----Very High Frequency
VIXS-----Navy's Video Teleconferencing
Information Exchange System
VNOSMP-----Vietnam Office for Seeking Missing
Persons
VOA-----Voice of America
VS-----Air antisubmarine squadron
VTC-----Video teleconferencing

W

WESTPAC-----Western Pacific
WHNS-----Wartime Host Nation Support
WRS-T-----War Reserve Stockpile-Thailand
WRS-Thai-----War Reserve Stockpile-Thailand
WWMCCS-----Worldwide Military Command and Control
System

UNCLASSIFIED

UNCLASSIFIED

THIS PAGE INTENTIONALLY LEFT BLANK

UNCLASSIFIED

~~SECRET~~

INDEX*

(U) Volumes I and II are integrated in this index and paginated consecutively. Volume I contains Chapters I through V, pages 1-298. Volume II contains Chapters VI through VIII, pages 299-412. The appendices are also included in Volume II, pages 413-492, but these are not indexed. Annexes to the USCINCPAC History are not indexed here as each has its own index.

A

Aaron, Capt George, 225
Acquisition Cross-Servicing Agreement, 249, 254
Actical Automated Digital Information Link, 311
Admiral, MajGen John, USMC, 145
[REDACTED] (b)(1)(1.4a)
Afloat Prepositioned Force, 267
Afloat Prepositioning Ships, 253
[REDACTED] (b)(1)(1.4a)
[REDACTED] (b)(1)(1.4a)
Ai Souliyaseng, LTG, 192
Air Combat Command, 53
Air Force Operational Test and Evaluation Center, 304
[REDACTED] (b)(1)(1.4a)
Air Mobility Command, 261
Airborne Self Protection Jammer, 278
Allied Command Information and Exchange System, 300
Allied Data Processing Publication-11 (AdatP-11), 312
Alternate Performance Appraisal System, (APAS), 18
American Legion, Veterans of Foreign Wars (VFW), 141
Amonquaykoone Sudachan, 212
[REDACTED] (b)(1)(1.4a)
AMVETS, 141
AN/TSC-122 HF Multichannel Communications Central, 306
[REDACTED] (b)(1)(1.4a)
Army Afloat Brigade at Diego Garcia, 267
Army Afloat Prepositioned Zero-based Study prepared by
 USTRANSCOM, 266
Army Afloat Prepositioning Ships, 253
[REDACTED] (b)(1)(1.4a)
Arthur, ADM Stanley, USN, nominee for USCINCPAC, 6
Asang Laoly, MG, 191
Ashby, PO2 Clayborn W., Jr., 178
Association of Southeast Asian Nations, 121, 296
Assumption of Command, 7
Australia-US Acquisition and Cross-Servicing Agreement, 249
Australia-US Logistics Working Party, 249
Automated Message Handling System, 317
Automatic Digital Network (AUTODIN), 304
Ayres, Maj Gerald F., 180

* Individual entries are unclassified. See Letter of Promulgation.

~~SECRET~~

SECRET

B

(b)(1)(1.4a)

(b)(1)(1.4c)

Bilateral Relationships, 297
Bilateral Training and Consultative Group, 314
Biscailuz, LCpl Robert L., USMC, 177
Bramlett, LTG David A., USA, USCINCPAC DCINC, 7, 279
Branch, Lt Col James A., USAF, 177
Brohm, BG Gerard P., USA, USCINCPAC Director for Command and
Control and Communications Systems (J6), 299, 316
(b)(1)(1.4c)
Bulk Fuel Company, 9th Engineer Support Battalion, 260
Bullock, 1st Lt Elmer W., 225
Bureau of Narcotics Enforcement, 103
Burns, Capt John R., USAF, 177
Byars, LCpl Earnest R., USMC, 177

C

C-141 Assets, reduced availability of, 266
C-levels, new definitions of, 59
C2 ADP Plans and Requirements Conference, 318
C2S2 LAN, 317
C3 Systems and Integration Division (J64), 299, 303
California Public Utilities Commission, 319
Cam Ranh Bay Naval Facility, 147
Cambodia, 204
 Archival Research Team Activities, 1994, 209
 1993 Joint Field Activities, 204
 1994 Joint Field Activities, 208
 Ambassador to, 118
 Assistance, 245
 Demining Program, 117
 Demining Training Assistance Program, 117
 Mine Awareness Committee, 117
Carrier Battle Group Schedule, 65
Cartwright, CAPT Billy Jack, USN, 181
Center for Naval Analysis, 362
Central Identification Laboratory, Hawaii (CILHI), 125
Central Joint Mortuary Affairs Office, 263
Chairman's Readiness System, 58
Change of command, 6

(b)(1)(1.4c)

China

Chinese and Sino-Thai heroin organizations, 91
(b)(1)(1.4c)
Chinese Visit to Hawaii, 132
Recovery Operations in, 135
Repatriation of Remains from, 134
Ship Visits to, 115

(b)(1)(1.4c)

SECRET

~~SECRET~~

Choumali Saignasone, LTG, 191
Christmas, MGen George, USMC, 131
Christopher, Warren, US Secretary of State 153
Chuan Leekpai, Prime Minister of Thailand, 253
CILHI, Identification of Remains, 1993-1994, 125, 177
Civil Reserve Air Fleet, 61
Clinton, President William Jefferson, 95, 142, 143, 144, 253
CNO ESC meeting, 328, 334
[REDACTED] (b)(1)(1.4c)
COBRA GOLD 94, 121, 261, 300, 312, 313
Cocaine, heroin, marijuana, 91
Cogdell, Capt William K., USAF, 179
Cold War remains returned, 225
Collazo, PFC Raphael L., 177
College-level tuition assistance, ROK, 15
[REDACTED] (b)(1)(1.4c)
Combined Interoperability Program, 310, 314
 Introduction to Armed Forces of the Philippines, 314
 Memorandum of Understanding with Australia, 310
 Negotiations with Japan, 313
Combined US-Thai Logistics Exercise 37, 252
Command, Control, Communications, and Computers, 62
Command and Control Interoperability Board, 310
Command Strategy, Pacific, 289
[REDACTED] (b)(1)(1.4c)
Commander's Intent, 294
Commander Joint Forces Australia, 311
Commission on POW/MIA, US-Russia Joint, 225
COMTHIRDFLT change of command, 339
Condit, 1st Lt Douglas C., USAF, 177
Conflict Component of the Pacific Command Strategy, 292
Containerized Munitions Project for the Pacific, 261
Contingency plans, status of USCINCPAC, 298
Contingency Theater Automated Planning System, 299, 304
Convention, 1982 Law of the Sea, 112
Coons, PO2 Chester L., 178
Cooperative Engagement, 241, 279, 289, 313
Corps Battle Simulation, 265
Counterdrug
 Security Issues, 95
 US Interdiction Coordinator Designated, 101
 Operations, USCINCPAC, 91
 Law Enforcement Agency Philosophy, 94
 Evolution of the USCINCPAC Counterdrug Program, 91
 Reorganization, USCINCPAC objections, 96
 Strategy, USCINCPAC, 91
Crandall, WO Gregory S., USA, 177
Cray, 152
Crisis Action Support Cell, 42
Customs Service, 92
CVBG Schedule Modified for Korea, 68

~~SECRET~~

~~SECRET~~

D

Daniell, VADM Martin H., USCG, 94
Danielson, Capt Mark G., 180
Dawson, PO3 Frank A., 178
DEFENSE FORUM magazine, 89
Defense Information Systems Agency Pacific, 319
Defense Logistics Agency, 259
Defense Red Switch Network, 306
Defense Secure Network 3 (DSNET-3), 45
Defense Technological and Industrial, 278
Demand Assigned Multiple Access, 304
Demining Programs, 116
 Cambodia, 117
 Laos, 119
Democratic People's Republic of Korea, (see, North Korea)
Deployable Joint Task Force Augmentation Cell, 43, 123, 250, 300
DESERT STORM, 65
Destruction of Documents, JTF-FA, 126
Developing Countries Combined Exercise Program, 241, 244
DIA Collection Management Office, 84
Disabled American Veterans (DAV), 141
DISTANT PHOENIX Operations, 84
[REDACTED] (b)(1)(1.4c)
[REDACTED] (b)(1)(1.4d)
Documents, Destruction of JTF-FA, 126
DOD Demining Operations, 116
DOD Worldwide High Frequency Radio Right-Sizing Plan, 307
Domestic Air Interdiction Coordination Center, 97
Donato, PO1 Paul N., 178
Done Somvorachit, 119, 185, 193
Drug threats
Dunham, Capt John R., 226

E

E-IMET, 277
[REDACTED] (b)(1)(1.4d)
Egger, Maj John C., USAF, 179
Eisenhower, President Dwight D., 269
Electronic Collateral Support System (ELCSS), 317
Electronic key management and distribution, 315
[REDACTED] (b)(1)(1.4c)
Electrospace Systems Incorporated, 306
Embargo Lifted, Economic and Trade, 144
Enhanced Moving Target Indicator, 46
Environmental Protection Agency, 258
[REDACTED] (b)(1)(1.4c)
Equipment Afloat Ships, 252
[REDACTED] (b)(1)(1.4c)
Executive Order 10436, 269

~~SECRET~~

~~SECRET~~

Exercises, 121

(b)(1)(1.4a)

LOGEX 37, 252

COBRA GOLD, 121, 261, 300, 313

FREEDOM BANNER, 260

TANDEM THRUST, 299, 346

(b)(1)(1.4a)

TEMPEST EXPRESS, 250

TEMPO BRAVE, 123, 300

TURBO CADS, 261

ULCHI FOCUS LENS, 95, 259, 263, 304

Expanded International Military Education and Training, 277

F

(b)(1)(1.4a)

Five Agreements, the, 139

Five-Year Defense Program, 54

Fleet Intelligence Training Center, Pacific, 46

Fleet Ocean Surveillance Information Facility, Western Pacific
(FOSIF WPAC), 17

Force Readiness Concerns, USCINCPAC, 51

Foreign Military Financing, 275

Foreign Military Sales, 275, 276

Foulks, LT Ralph E., Jr., USN, 177

Framework Agreement, US/North Korea, 34

Frederick, Capt David A., USMC, 177

Freedom of Navigation Operations, USCINCPAC, 112

(b)(1)(1.4a)

Frink, WO1 John W., USA, 179

G

Gaming and Simulation Facility, 265

Gardner, MajGen Donald R., USMC, 122

Gile, BG Greg, USA, 122

Global Command and Control System, 62, 318

Global Naval Force Presence Policy, 65

GLORY, 215

Goals, J2, 41

Gober, Hershel, 141, 191

Gold, CDR Edward F., USN, 180

Goldwater-Nichols Act, 75

Griffiths, Ann Mills, 192

Ground Mobile Forces, 300

GTE-Hawaiian Telephone, 318

(b)(1)(1.4a)

GUARDRAIL Deployment to USPACOM, 85

H

Hall, CAPT Harley H., USN, 180

Hangen, Welles, 177

~~SECRET~~

~~SECRET~~

(b)(1)(1.4a)

Hawaiian Telephone, 318
Heroin, 91
Herr, VADM Richard D., USCG, 94, 98, 99
Hershel, Gober, 145
Hessom, CDR Robert C., USN, 180
High Frequency Radio Network Consolidations, 306
Hoffman, Cpl Terry A., USMC, 179
Honolulu Police Department, 103
Hou Binh, 344
Humanitarian Assistance Program for Excess Property (HAP-EP),
245, 246
Humanitarian Demining Programs, 116
Humanitarian/Civic Assistance, 241
Hump, the, 135
Hurricane JOHN, 301

(b)(1)(1.4a)

I

IAEA Nuclear Safeguards Agreement, 34
Identification of remains, 178
From Korean War, 225
III Marine Expeditionary Force, 258
Immigration and Naturalization Service, 111
In-Transit Visibility, 262

(b)(1)(1.4a)

INFOSEC Conference, 315
Integrated Tasking Order, 304
Intelink, 44
Intelink-S, 45
Intelligence Augmentation Team, 43
Intelligence Support Team, 44
Intelligence Support to Joint Operations, 42

(b)(1)(1.4a)

International Atomic Energy Agency (IAEA), 33, 34
International Maritime Satellite, 307
International Military Education and Training, 247, 275

(b)(1)(1.4a)

International Security Affairs, 245
Interoperability Management Board, 314
Iwakuni, 258

J

J2 Goals, 41
J6 Reorganization, 299
Jacoby, RADM Lowell E., USN, USCINCPAC Director for Intelligence
(J2), 41
JANAP 128, 304
Japan Combined Interoperability Program Negotiations, 313
Japan Reconfiguration and Digitization, 305
Japanese Technology Transfer, 279

~~SECRET~~

~~SECRET~~

JIATF

(East), 97

(South), 97

(West), 97

Activation of JIATF WEST, 98

JIATF WEST Special Operations, 101

JICPAC Detachment

Intelligence Support Teams, 44

Relocation, 45

JICPAC

Intelligence Augmentation Teams, 43

Operational Intelligence Center, 42

Johnston Island, 301

(b)(1)(1.4a)

Joint Army, Navy, Air Force Pacific Publication 128, 304

Joint Commission on POW/MIA, US-Russia, 225

Joint Crisis Management Capability-1, 301

Hatchmount Suite, 301

Joint Defense Intelligence Support System, 43

Joint Deployable Intelligence Support System, 299

Joint Drug Intelligence Group, 103, 104

Joint Frequency Management Office-Pacific (JFMO-PAC), 316

Joint Heroin Analysis Team, 103

Joint Intelligence Center, Pacific Detachment (J-Det), 44

Joint Intelligence Center Pacific, 41

Joint Intelligence Training Activity, Pacific, 46

Joint Interagency Task Force

(South) in Panama, 97

(Transit) in Key West, Florida, 97

West (JIATF WEST), 9

Joint Labor Policy Committee, 15

Joint Logistics-Over-the-Shore, 260

Joint Meritorious Unit Award, JICPAC, 14

Joint Military Technology Commission, 280

Joint Monthly Readiness Review (JMRR), 58

Joint Mortuary Affairs Office-Pacific, 263

Joint readiness, 58

Joint Strategic Capabilities Plan, 51, 289

(b)(1)(1.4a)

Joint Task Force-5 (JTF-5), 9, 92

Joint Task Force-Full Accounting (JTF-FA), 126

Joint Training Master Plan, 46

Joint Worldwide Intelligence Communications System, 45, 303

Jones, MSgt Robert W., 225

JTF-5

redesignation of as JIATF (West), 98

JTF-5/JIATF WEST Special Operations, 101

(b)(1)(1.4a)

JTF-FA

Identification of Remains, 1993-1994, 177

Trilateral Coordination Talks, 210

Destruction of Documents, 126

Situation Reports, 1993 and 1994, 226

JUSMAGTHAI, 257

~~SECRET~~

~~SECRET~~

K

Kaho'olawe Island, return of to State of Hawaii, 269

(b)(1)(1.4c)

(b)(1)(1.4c)

Karger, LT(JG) Barry E., USNR, 178

Karst, Col Carl F., USA, 178

Keller, Capt George R., USAF, 179

Kelly, ADM Robert J., USN, CINCPACFLT, 10

Keovixay, Major Sikahi, 212

Khamphoui Keoboualapha, 192

(b)(1)(1.4c)

Kim Chong-il, 27

(b)(1)(1.4c)

Kime, ADM J. William, USCG, Commandant of the Coast Guard, 101

Kobe Earthquake Relief Support, 258

Korat Munitions Storage Area, 257

(b)(1)(1.4c)

(b)(1)(1.4a)

Korean Combat Support System, 304

Korean Nuclear Threat, North, 33

(b)(1)(1.4a)

Korean War, Identification of Remains from, 225

Kramek, ADM Robert E. USCG, 101

Kravitz, LT James S., 178

Krulak, LtGen Charles C., USMC, COMMARFORPAC/CG FMFPAC, 10

Kulland, 1LT Byron K., USAR, 179

(b)(1)(1.4a)

L

Lao People's Democratic Republic (Laos), 181

Ambassador Victor L. Tomseth, 119, 181, 187, 212

Archival Research Team Activities, 184

Consultative Meetings, 1993, 185

Consultative Talks, 187

(b)(1)(1.4a)

Demining Program, 119

Joint Field Activities, 1993, 193

Joint Field Activities, 1994, 199

Visit by League of Families Delegation, 192

Visit by Presidential Delegation, 191

Visit by USCINCPAC, 192

Visit to USCINCPAC, 193

Larson, ADM Charles R., USCINCPAC, 27

Law of the Sea Convention, 1982, 112

Le Bang, Ambassador, 155

Le Mai, 141, 210, 211

(b)(1)(1.4a)

Le Minh Tran, 211

~~SECRET~~

~~SECRET~~

League of Families of American Prisoners and Missing in Southeast Asia, 192
Leahy, RADM William P., Jr., USCG, first commander of JTF-5, 93
Lee, Capt Glenn H. N., USAF, 179
Leyte Landing 50th Anniversary, 344
Light-water reactors, for North Korea, 34
Linnon, RADM John L., USCG, 93
Linthong Phetsavanh, 193
Local Digital Message Exchange (LDMX), 317
Logistics and Security Assistance, 241
Logistics Conference, USCINCPAC, 265
Logistics Cooperation Committee, 248
Logistics Plans, 265
Logistics Resources, 257
Logistics Response Cell, 258
Logistics Review Talks, 249
Logistics Working Party, 249
Logistics/Sustainment, 60
Loheed, CAPT Hubert B., USN, 179
[REDACTED] (b)(1)(1.4a)
Lord, Winston, 141, 142, 145
Lu Hanlin, 131

M

Macke, Admiral Richard C., 253
Makua Valley Open Burning/Open Detonation, 258
Malaysia Combined Interoperability Program Brief, 314
Malaysian Ministry of Defence, 314
Marijuana, 91
Marine Corps Tactical System Support Activity, 305
Maritime Defense Zone Pacific, 93
Martin, PO2 James E., 178
McCain, Senator John, "Going Hollow
Meadows, Capt Eugene T., USAF, 180
[REDACTED] (b)(1)(1.4a)
Mercer, SMSgt Jacob E., 180
Message Text Format, 311, 312
MIA Resolution Efforts, 125
Military Armistice Commission, 214
[REDACTED] (b)(1)(1.4b) (b)(1)(1.4a)
Military family housing, 319
Military Representatives (MILREPS), 329
Military Sealift Command, 78, 262
[REDACTED] (b)(1)(1.4b)
[REDACTED] (b)(1)(1.4e)
Missing Aircrew Reports, 135
Mobility Operations and Logistics Plans, 265
Mogadishu, 67
Morales, SGT Frank M., USA, 225
Mortuary Affairs Office, Central Joint, 263

~~SECRET~~

SECRET

Moving Target Indicator, 46
Multilevel Information Systems Security Initiative, 309
Munitions
 Containerization Working Group, 261
 Movement of largest since DESERT STORM, 262
 Preferred Munitions Forward Program, 257
 Storage Review, 257
Mutual Defense Assistance Office (MDAO), Japan, 280

N

National Drug Control Strategy, 99
National Interdiction Command and Control Plan, 96, 98
National Military Command Center, 63
National POW/MIA Operations Reorganized, 125
National Security Strategy, 289
National Weather Service (NWS) Marine Weather Forecasts, 307
Naval Magazine Lualualei, 101
Naval Research and Development (NRaD), 351
Naval Telecommunications Center, 317
Needham, MG Thomas H., USA, JTF-FA, 10, 126, 152, 153, 155, 185,
 210, 212
New Zealand, USCINCPAC visit to, 332
Nguyen Dinh Bin, 212
 (b)(1)(1.4e)
Nguyen Xuan Phong, 212
Noncombatant evacuation operation, Somalia, 67
 (b)(1)(1.4b)
North Korea (DPRK), 27
 Arms Sales, 36
 Ballistic Missile Threat, 35
 Chemical and Biological Warfare Capabilities, 38
 (b)(1)(1.4b)
 Framework Agreement, US/North Korea 34
 Light-water reactors, 34
 (b)(1)(1.4b)
 Nuclear Threat, 33
 Return of remains from North Korea, 1993-1994, 224
 Weapons Sales, 37
 Yongbyon, North Korea, 34
Northern Limit Line, 33
Nouhak Phommavanh, 191
Nuclear Non-Proliferation Treaty, 33
Nuclear Safeguards Agreement, 33
Nuclear Threat, North Korea, 33

O

Oahu Consolidated Family Housing Office, 318
Office of Humanitarian Assistance, 245

SECRET

~~SECRET~~

Officer in Tactical Command Information Exchange System, 299
Offshore Petroleum Discharge System, 260
OP3 for Korea, 90

Operations

DESERT STORM, 65
GLORY (1954), 215
NAZARETH, 107
STARFISH, 101
STINGRAY, 101, 105
TIGER CAGE, 107, 109
TIGER TRAP, 109
TURKEY HUNT, 102
WIPEOUT, 103, 109

Operations and Training, 65

Operations Deputies Conference Room, 63

Operations Plans, 298

(b)(1)(1.4b)

Operations Support System, 318

Operations/Intelligence Multi-Level Security, 309

OPORDERS

5080-93, 128

91-1, 128

Over-the-Air Rekeying Procedures, 315

Over-the-Air Transfer Procedures, 315

Overseas Family Residency Program, 54

P

(b)(1)(1.4c)

Pacific Area Cooperative Acquisition and Logistics System, 250

Pacific Area Senior Officer Logistics Seminar (PASOLS), 249, 250,
252, 341

Pacific Command Security Assistance Conference (PACSAC), 279

Pacific Command Strategy, 289

Pacific Intelligence Board, 41

Pacific Senior Communicators Meeting, 316

Pacific Video Teleconferencing Network, 303

Pak, Senior Colonel (SRCOL) Rim-Su, 222

(b)(1)(1.4b)

Participation of Defense Personnel of Developing Countries in
Bilateral or Regional Conferences, 241

Participation of Developing Countries in Bilateral or
Multilateral Military Exercises, 241

Paschall, SP5 Ronald P., USA, 179

(b)(1)(1.4b)

Peacetime Component of the Pacific Command Strategy, 290

Peacetime Engagement, 289

(b)(1)(1.4b)

People's Republic of China, POW/MIA recovery efforts, 131

Performance Evaluation Group Reports, 280

Personal Computer Message Terminal, 317

Personnel Expenses Authority for Developing Countries, 241, 243

Pilot Repair Program, 249

~~SECRET~~

~~SECRET~~

Plain Old Telephone System, 299
Plans, status of USCINCPAC contingency, 298
Plans and Separately Issued Annexes/Appendixes, USCINCPAC
Numbered, 298
Plans/Instructions, Unnumbered USCINCPAC, 300

(b)(1)(1.4b)

PONY EXPRESS, 77, 78, 82
Port visits by ships in USPACOM, USCINCPAC established policy
for, 115

POW/MIA

Operations Reorganized, 125
Resolution efforts, 125

Preferred Munitions Forward Program, 257
Presidential Decision Directive (PDD) 14, 95
Presidential Delegation Visits to Vietnam, 141

(b)(1)(1.4b)

Processing and Display Subsystem, 304
Programs,

(b)(1)(1.4a)

Psychological Operations, 89
Public Law 103-89, 18
Public Utilities Commission, Hawaii, 319

(b)(1)(1.4a)

Q

Quang Ninh, 344
Quinn, Mr. Kenneth, 131, 133, 211

R

Ramos, President Fidel V., Republic of the Philippines, 326, 344,
347

Ranch, The, 326, 344

(b)(1)(1.4a)

Readiness

Joint, 58
Status of, 54
Concerns, USCINCPAC Force Readiness, 51
Reporting System, new, 58
Chairman's Readiness System, 58

Ready Reserve Fleet, 61, 262
Reception, Staging, Onward Movement, and Integration (RSO&I)
Seminar and Exercise, 265

(b)(1)(1.4a)

Recovery Operations in China, 135

(b)(1)(1.4a)

~~SECRET~~

~~SECRET~~

Regional Policies, 295

Remains

 Cold War Remains Returned, 225
 Identification of, 178
 Identification of from Korean War, 225
 Repatriation of from China, 134
 Return of from North Korea, 1993-1994, 224
 United Nations MIA/Remains Discussions, 1993, 213
 Remains Discussions, 1994, ROK, 217
Republic of Korea Command and Control Interoperability Board, 311
ROK, Remains Discussions, 1994, 217
ROK SPIDER, 311
ROK-US Defense Technological and Industrial, 278
ROK-US Logistics Cooperation Committee, 248
ROK-US Security Consultative Meeting, 248
ROK-US Security Cooperation Committee, 277
Rokosz, BG Ronald F. USA, COMSOPAC, 89
Ross, Edward, 131, 133, 211
Royal Australian Air Force, 249
 (b)(1)(1.4b)
Royal Canadian Mounted Police, 103
Royal Thai Air Defense System, 312, 313
Royal Thai Navy, 312
Royal Thai Police, 110
Royal Thai Supreme Command, 313
Royal United Services Institute of Australia (RUSIA), 341
RP-US Mutual Defense Board, 348
Running, Maj Gen Ronald, USAF, 215
Ryan, Lt Gen Michael E., USAF, 141

S

(b)(1)(1.4b)

Sagami Depot, 258
Salmon, Ambassador Charles B., Jr., 181
Scott, Sue, 192
Secure Network Server Installation at USCINCPAC, 309
Security Assistance, 241, 275
 Pacific Command Security Assistance Conference, 279
 Security Assistance Training, 277
Security Consultative Committee, 331
Security Consultative Meeting, 248, 343
Security Cooperation Committee, 277
Senior Communicators Meeting, 316
SEVENTH Fleet, 76, 299, 300
 (b)(1)(1.4a)
Sharpe, Brig Gen Ervin C., USAF, 135
Shine, Colleen, 192
Ship Visits to China, 115
Ships
 (b)(1)(1.4a)
 USS ANTIETAM (CG 54), 114
 USS BLUE RIDGE (LCC 19), SEVENTH Fleet command ship, 116,
 299, 300

~~SECRET~~

~~SECRET~~

USS BUNKER HILL (CG 52),, 115
USS CARL VINSON (CVN 70), 65

(b)(1)(1.4a)

(b)(1)(1.4a)

Cable Ship (CS) ENTERPRISE, 305

(b)(1)(1.4a)

USS FLETCHER (DD 992), 113
USS GEM STATE, 262
USS GEORGE PHILIP (FFG 12), 107, 108

(b)(1)(1.4a)

USS GERMANTOWN (LSD 42), 114
Ready Reserve Fleet ship GREEN WAVE, 262

(b)(1)(1.4a)

USS HARRY W. HILL (DD 986), 113
USS HORNE (CG 30), 113

(b)(1)(1.4a)

USS JOHN A. MOORE (FFG 19), 104

(b)(1)(1.4a)

USS LEWIS B. PULLER (FFG 23), 108, 109, 110, 111
MERCATOR, USN P4M-1Q, 133
USCGC MUNRO (WHEC 724), 102
NEPTUNE, USN P2V, 133

(b)(1)(1.4a)

USS NIAGARA FALLS (AFS 3), 113

(b)(1)(1.4a)

USS OLDENDORF (DD 972), 113

(b)(1)(1.4a)

USS RANGER (CV-61), 6
USS RECLAIMER (ARS 42), 101, 106
Fast Sealift Ship (FSS) REGULUS, USNS, 257, 261
USS REUBEN JAMES (FFG 57), 114
USCGC RUSH (WHEC 723), 107
USS SIDES (FFG 14), 108, 111
MV STRONG TEXAN, 257
USS THACH (FFG 43), 113

(b)(1)(1.4a)

USS TRUXTUN (CGN 35), 107, 109, 110

USS VALLEY FORGE (CG 50), 111

USS WADSWORTH (FFG 9), 104, 107

(b)(1)(1.4a)

Singapore Command and Control Interoperability Board, 311
Single Channel Air Ground Radio System, 311
Sino-Thai heroin organizations, 91
Situation Reports, 1993 and 1994, JTF-FA, 226
Smith, Lt Col Richard D., USAF, 180
Socialist Republic of Vietnam, 325
Somalia noncombatant evacuation operation, 67

~~SECRET~~

~~SECRET~~

Somsavat Lengsavad, 192, 193
Somvorachit, Done, 119, 185, 193
Soubanh Srithirath, 189, 191, 192, 210, 212, 213
South Block, 347

(b)(1)(1.4b)

Southeast Asia, identification of remains, 178
Southeast Asia Collective Defense Treaty (Manila Pact), 121
Special Intelligence Communications, 306
Special Measures Agreement (SMA), 16
Special Operations, USCINCPAC, 88
Special Operations Command Pacific, 89

(b)(1)(1.4b)

Spectrum Management Conference, 315
Stackpole, LtGen Henry B., USMC, COMMARFORPAC/CG FMFPAC, 10
Standard Telecommunications, 299
Strategic Planning and Policy, 289
Submarine fiber optic cable, 305
Sun SPARC Workstation, 317
Survivable Communications Integration System, 304

(b)(1)(1.4b)

Systems Integration Division (J61), 299

T

Tactical Army Command, Control and Information Management System,
304

Tactical data link (TADIL), 312

Tan Van Quang, LTG (Ret), 146

(b)(1)(1.4a)

Task Force RUSSIA, 226

(b)(1)(1.4a)

Technological and Industrial, 278

Technology Review Group, 313

Telecommunications Management, 299

Telephone service, unofficial, 318

TEMPO BRAVE, 123

Thai Counter Narcotics Task Force command center in Chiang Mai,
107

Thai Supreme Command's Director of Communications (LTG Vinai),
312

Thailand Command and Control Interoperability Board, 312

The Ranch, 326, 344

The Warnings of Our Chiefs of Staff, 51

Theater Command and Control System, 299, 300, 318

(b)(1)(1.4a)

Thurman, LT Curtis F., 178

Tibetan Autonomous Region, 135

TIGER CAGE, 107, 109

Title 10, 241, 244

Tomseth, Ambassador Victor L., Ambassador to Laos, 119, 181, 187,
212

Tozzi, RADM J. T. USCG, 99

(b)(1)(1.4b)

Trilateral Coordination Talks, 210

~~SECRET~~

~~SECRET~~

TSC-122 HF Multichannel Communications Central, 306
Tuition assistance, ROK, college-level, 15
Twining, Ambassador to Cambodia, 118

U

(b)(1)(1.4a)

[REDACTED]

UN Security Council, 34
Unified Commanders' Conduct of Cooperative Programs, 241
United Nations MIA/Remains Discussions, 1993, 213
United States Customs Service, 92
United States Information Service, 89
Units (numbered)
 2nd Aviation Battalion, 56
 9th Engineer Support Battalion, 260
 10th Mountain Division (Light), 122
 [REDACTED] (b)(1)(1.4a)
 25th Infantry Division (Light), 56, 258
 [REDACTED] (b)(1)(1.4a)
 102nd Military Intelligence Battalion, 77
 1854th Combat Information Systems Squadron, 318
Unofficial telephone service, 318
US Army Central Identification Laboratory, Hawaii (CILHI), 125
 [REDACTED] (b)(1)(1.4a)
US Message Text Format, 312
US Military Academy, West Point, 335
US Naval Academy, 7
US Navy High Command (HICOM) HF Network, 307
US Transportation Command, 262
US Western Hemisphere Drug Policy, 95
US-Australian Logistics Review Talks, 249
 [REDACTED] (b)(1)(1.4b)
US-ROK Defense Technological and Industrial, 278
US-ROK Security Cooperation Committee, 277
US-Russia Joint Commission on POW/MIA, 225
US-Vietnam joint field investigation effort, 139
US/Australia Command and Control Interoperability Board, 310
US/Japan Interoperability Management Board, 314
US/Japan Technology Review Group, 313
USAF Global HF System, 307
USCINCPAC
 Counterdrug Program, Evolution of, 91
 Deployable Joint Task Force Augmentation Cell, 123
 C2 ADP Plans and Requirements Conference, 318
 Exercises, 121
 INFOSEC Conference, 315
 Security Assistance Training, 277
 USPACOM ADP Server Site, 41
 WWMCCS ADP Plans and Requirements Conference, 318

~~SECRET~~

~~SECRET~~

V

VAQ 137, 56
Viale, BG Charles R., USA, CJTF-FA, 10, 155, 212
Video teleconferencing, 300
 VTC Information Exchange System, 303
Vietnam, Socialist Republic of, 325
 Vietnam, 1994 Presidential Delegation Visit to, 145
 Archival Research Team, 148
 Bi-Monthly Technical Talks, 1994, 154
 Cam Ranh Bay Naval Facility, 147
 Economic and Trade Embargo Lifted, 144
 Five on-going special research and investigative
 initiatives, 148
 Joint Field Activities, 1993, 157
 Joint Field Activities, 1994, 168
 Joint Research Activities, 1993, 149
 Joint Research Activities, 1994, 151
 Long Range Plan for POW/MIA Operations in, 147
 Oral History Program, 148
 Presidential Delegation Visits to, 141
 Priority Case Investigation Team, 148
 Repatriation of Remains from Hanoi, 1993-1994, 176
 Special Remains Team, 148
 STONY BEACH, 148
Vo Van Kiet, 152
Vu Chi Cong, 154, 212

W

War Reserve Stockpile-Thailand, 252, 257
Warner, ASD Edward L., III, 116
Wartime Host Nation Support, 248
Waterman, 1stLt Craig H., USMC, 177
 (b)(1)(1.4b)
West Point, US Military Academy at, 335
 (b)(1)(1.4b)
Wiedemann, Kent, 210
Wilkinson, Chargé A. I., 185
Wold, James, 145, 212
Wonn, ENS James C., 178
WWMCCS ADP Plans and Requirements Conference, 318
Wyman, George M., 17

Y

(b)(1)(1.4b)
Yongbyon, North Korea, 34

Z

Zlatoper, ADM Ronald J., USN, CINCPACFLT, 10

~~SECRET~~

